

**Iowa Department of
Homeland Security and Emergency Management**

**Next Generation 911 Wireless
Implementation and Operations Plan
2018**



HISTORY AND AUTHORITIES 4

Key Legislation 5

Administrative Rules/Statewide Implementation Plan 6

Plan Criteria 6

SURCHARGE AND FUNDING 6

Priority of Eligible Costs (Emergency Communications Service Surcharge) 7

ELIGIBLE COSTS..... 8

HSEMD Program Management 8

Joint 911 Service Boards and the Iowa Department of Public Safety 8

 Wireline Surcharge 9

 Emergency Communications Service Surcharge 9

 PSAP Eligible Costs 9

Wireless Service Providers (Cost Recovery) 10

 Wireless Service Provider Eligible Costs 11

NG 911 Network Services 12

 NG911 Network Costs 12

 911 Call Processing Equipment Providers 12

 911 Call Transport Providers 13

 ALI providers 14

 GIS Grants 14

Catastrophic Reserve 14

Physical Consolidation Grants 15

Public Awareness, Educational Programs, and 911 Council Travel 15

Remaining Pass-through Funds 16

OPERATIONAL PROCESSES..... 16

HSEMD 16

 Manage the Network16

 Maintain and Oversee the Shared Services Environment17

 Manage the Network Change Request Process17

Originating Service Providers 18

911 Call transport Provider (ICN) 18

Next Generation 911 Network Service Provider (Comtech TCS) 19

911 Call Processing Equipment Provider (Zetron)..... 20

PSAPs and Joint 911 Service Boards 20

NETWORK DESIGN 21

Wireless 911 Network Design..... 22

Wireline 911 Network Design..... 23

Primary ESInet 24

Secondary ESINet 25

PSAP Connectivity 26

Text to 911 26

NG911 GIS Guidelines 27

 Standards27

 Compliance27

ATTACHMENTS 28

History and Authorities

In 1986, the Iowa General Assembly passed a law creating a 29-member state emergency telephone number commission. One charge of the commission was to study the issue of statewide implementation of 911 service and provide written recommendations in the form of a report. The commission issued its report in January 1987, and legislative language contained in the report became House File 2400, which was adopted by the General Assembly and signed into law by Gov. Terry Branstad in May 1988. Since its passage, several amendments to this law have been passed and it has been recodified as Iowa Code Chapter 34A.

Under the provisions of Chapter 34A, the Iowa Department of Homeland Security and Emergency Management (HSEMD) 911 Program has the responsibility for the administration of the Iowa 911 Program. The law requires each county in the state to establish a joint 911 service board. Each board has the responsibility to develop a countywide 911 plan detailing the manner and cost for the implementation of a 911 system. The Department has the responsibility to review and approve these plans. All 99 counties have approved 911 service plans.

In 1996, the Federal Communications Commission (FCC) put forth a mandate requiring the implementation of wireless 911 service, and for the service to function similarly to wireline 911.

Senate File 530 passed the Iowa General Assembly in 1998. This law provided for a statewide surcharge on wireless communications, including cellular, personal communication services, and commercial mobile radio services. Under this law, HSEMD has the responsibility for the wireless 911 program.

In 2012, new Iowa Code § 34A.7B, prepaid wireless 911 surcharge, imposed a retail point of sale surcharge on the purchase of prepaid wireless telecommunication service.

Key Legislation

The management and administration of the 911 program in Iowa has changed a number of times. The table below sequentially lists key legislative changes.

Legislative Title	Action	Year
HF2400	<ul style="list-style-type: none"> Created wireline surcharge 	1988
SF530	<ul style="list-style-type: none"> Created wireless surcharge and set the rate at 50 cents per line per month. 	1998
SF2298	<ul style="list-style-type: none"> Increased wireless surcharge to 65 cents per line per month 	2004
SF2332	<ul style="list-style-type: none"> Created prepaid wireless surcharge Increased pass-through amount of surcharge to the public safety answering points (PSAP) from 25 to 46 percent VoIP providers required to remit surcharge 	2013
HF644	<ul style="list-style-type: none"> Increased wireless surcharge and equalized wireline surcharge to \$1 per line per month 	2014
HF651	<ul style="list-style-type: none"> Created fund for the purposes of 911 Council travel, public education, and training for 911 personnel Standardized language throughout 34A for usage of the surcharge to include costs related to the receipt and disposition of a 911 call 	2015
HF2439	<ul style="list-style-type: none"> Increased the wireless pass-through from 46 to 60 percent Introduced PSAP consolidation grants Created catastrophic reserve fund 	2016
SF500	<ul style="list-style-type: none"> GIS grants instituted Limited consolidation grants to physical consolidation only Modernized antiquated language Included GIS representation onto 911 Council Included local emergency management representation onto joint 911 service boards 	2017
HF2254	<ul style="list-style-type: none"> Directed HSEMD to implement virtual consolidation plan (merging legacy wireline 911 network onto NG911 network and introducing shared PSAP services) 	2018

Administrative Rules/Statewide Implementation Plan

HSEMD, with the cooperation of the 911 Communications Council, developed the administrative rules to implement the enacted legislation. Iowa Administrative Code, Section 605, Chapter 10 implements Iowa Code Chapter 34A and the associated elements of the 911 program.

The development of the Statewide Wireless 911 Implementation and Operations Plan began in 1999. The plan undergoes regular updates as needed, and utilizes information gathered from the 911 Communications Council, local joint 911 service boards, PSAPs, wireless service providers, wireline service providers, and State agencies. The plan underwent significant updates in both 2015 and 2018 to reflect modernization of terminology, and to document updates to the program through changes to Iowa Code Chapter 34A.

Plan Criteria

As specified in Iowa Administrative Code 605.10.7, this plan contains the following elements:

- Maps showing the geographic location of each PSAP within the county receiving 911 emergency calls
- A list of public safety answering points within the state of Iowa
- A set of guidelines for determining eligible cost as set forth in Iowa Code § 34A.7A
- A schedule for the implementation and maintenance of the next generation 911 network
- A schedule for the implementation, maintenance, and cost sharing of 911 call processing equipment

Surcharge and Funding

More than one funding stream funds the 911 emergency communication system. One source is a surcharge of \$1 per month per access line on each access line subscriber. Additional funding streams used to supplement surcharge funding include other local, State, and federal revenue sources.

Wireline surcharge: Provider remits wireline surcharge directly to local 911 service boards at the rate of \$1 per line per month. This includes static VoIP providers.

Emergency Communications Service Surcharge or Wireless Surcharge: Wireless surcharge is legislatively termed “emergency communications service surcharge” and is remitted to HSEMD quarterly, at the rate of \$1 per line per month. This includes nomadic VoIP providers. Additional description and breakdown of wireless surcharge is included in the following section.

Prepaid surcharge: The Iowa Department of Revenue accepts and processes the remittance of prepaid surcharge. The current rate is 51 cents per retail transaction. At the end of each quarter, the department transfers the money to the emergency communication service surcharge managed by HSEMD.

Priority of Eligible Costs (Emergency Communications Service Surcharge)

The expenditure of emergency communications service surcharge funds strictly adheres to Iowa Code § 34A.7A specifying the order to expend the funds. The order is as follows:

- An amount appropriated by the Iowa General Assembly to HSEMD for program management
- 60 percent of the total quarterly surcharge revenue generated to joint 911 service boards and the Iowa Department of Public Safety (DPS) via a defined formula
- Wireless service providers for actual costs to deliver wireless 911 phase 1 services (10 percent of actual surcharge revenue)
- Next generation 911 network service providers, 911 call processing equipment providers, 911 call transport providers, third-party ALI database providers, and grants to joint 911 service boards for the purpose of developing and maintaining NG911 GIS data
- A reserve account up to 12.5 percent of the surcharge collected each year for the purposes of catastrophic network failure

Any remaining funds, after the aforementioned obligations are paid, adhere to the following priority order:

- Up to \$200,000 for each PSAP agreeing to physically consolidate. The grants shall be no more than half of the total cost of the PSAPs consolidation and are available through June 2022
- Up to \$100,000 for the purposes of 911 Council travel, public education, and training for personnel responsible for the maintenance, operation, and upgrading of local 911 systems
- The remaining funds shall be allocated equally to each PSAP and distributed to joint 911 service boards. Funds shall only be expended for costs related to the receipt and disposition of 911 calls, including hardware and software for the next generation 911 network and local costs related to accessing the state’s interoperable communications system

The next section (Eligible Costs) provides additional information regarding the allowable expenditures of the 911 surcharge.

Eligible Costs

Iowa Code Chapter 34A, along with Iowa Administrative Code § 605.10, provides guidance for eligible expenses of surcharge. This plan further defines each eligible cost listed in the previous chapter, along with a listing of types of eligible costs.

HSEMD Program Management

Currently set by the Iowa General Assembly, \$250,000 per year shall be utilized for implementation, support, and maintenance of the functions of the 911 program director and manager, and to employ the Auditor of State to perform an annual audit of the 911 emergency communications fund.

Nonrecurring Costs

- State audit
- Department of Administrative Services
 - Procurement

Monthly Recurring Costs

- Salary and benefits
- Consultants for engineering and program management of 911 program
- Facilities
 - Rent
 - Utilities
 - IT support

Joint 911 Service Boards and the Iowa Department of Public Safety

One source of funding for the 911 emergency communications system comes from a surcharge of \$1 per month per access line on each access line subscriber. Funding of 911 systems is not limited to the surcharge. Other local, State, and federal revenue sources may supplement the 911 emergency communications system's budget.

The 911 Surcharge Fund revenues are derived from 911 surcharge collection and any interest those funds may receive. Expenditures from the 911 Surcharge Fund reflect only expenditures allowable under the provisions of Iowa Code Chapter 34A.

The 911 Operating Fund is designed to reflect revenues from all the sources other than the 911 surcharge. This includes city and county contributions and the proceeds from bonds issued under the Iowa Finance Authority 911 finance program as provided in Iowa Code §§ 34A.20-22. Expenditures from the 911 Operating Fund reflect those made for 911 purposes and may be for purposes in excess of those allowed under the provisions of Chapter 34A (i.e. building and personnel expenses).

Wireline Surcharge

Wireline surcharge funds are remitted directly from the provider to local 911 service boards. These funds shall first be spent for actual recurring costs of operating the local 911 service plan. If money remains in the fund after paying for recurring costs, the remainder may be spent to pay for nonrecurring costs, not to exceed actual nonrecurring costs as approved by the program manager. The service board may request, not more than once per quarter, the following information from the local exchange service provider:

- The identity of the exchange from which the surcharge is collected
- The number of lines to which the surcharge was applied
- The number of refusals to pay per exchange
- Write-offs applied per exchange
- The number of exempt lines per exchange
- The amount retained by the local exchange service provider

NOTE: Access line counts and surcharge remittances are confidential public records.

Emergency Communications Service Surcharge

Each PSAP shall receive a minimum of \$1,000 per calendar quarter. The distribution of the remaining funds uses a formula dividing the surcharge funds among the PSAPs accepting wireless 911 calls.

The formula is as follows:

- Total dollars available x 65 percent x (square mile of service area)
PLUS
- Total dollars available x 35 percent x (number of wireless 911 calls taken at the PSAP)
- The processing of funds will occur by the 40th calendar day after the close of the calendar quarter. Disbursement of funds occurs every quarter.

PSAP Eligible Costs

PSAPs are only allowed to use allocated funds for nonrecurring and recurring costs pertaining to the receipt and disposition of the 911 calls. The eligible cost detailed below, specifically

excludes costs attributable to other emergency services or expenditures for buildings or personnel (except for the costs of personnel for database management and personnel directly associated with addressing). Eligible expenses of surcharge funding under this section are the same regardless of source (wireline or wireless).

Nonrecurring Costs

- Installation of HVAC/fire suppression for facilities associated with the receipt and disposition of 911 calls
- Installation of redundant or backup communications equipment
- Hardware/software upgrades
- Equipment housing furniture
- Technician fees
- Consultants
- Communications towers
- Radios
- Customer premise equipment
- Radio consoles/consolette
- Computer aided dispatch
- Mapping
- Logging recorder
- Emergency dispatch protocols
- Paging equipment
- Emergency communications PSAP related operational costs

Recurring Monthly Costs

- NG911 GIS
- Standalone ALI database
- Service fees
- Maintenance fees
- Training
- ALI/MSAG services
- Emergency communications PSAP-related operational costs
- ESInet (Emergency Services IP Network)
- POI (Point of interconnection)

Wireless Service Providers (Cost Recovery)

From July 2013 through June 2026, the program manager shall allocate 10 percent of surcharge generated to wireless service providers (WSP) to recover their actual costs associated with the

delivery of wireless 911 phase 1 services. The WSP shall request reimbursement for expenses incurred in the previous calendar quarter from the 911 program manager no later than the 20th day following the close of the calendar quarter. Requests for reimbursement received after the 20th day following the close of the calendar quarter will not be eligible for reimbursement in that quarter. The reimbursement request must include a breakout of the costs, with original invoices, using the above eligible cost list and the Reimbursement Request Form ([Attachment A](#)).

The 911 program manager will then process the request and distribute payment within 40 calendar days of the close of the calendar quarter.

In cases where the amount requested for reimbursement exceeds the amount available to disburse, the 911 program manager shall take all reimbursement requests and remit a payment to the WSP based on a percentage of the WSP-eligible expenses as compared to the total of all eligible expenses for all WSPs for the quarter.

Wireless Service Provider Eligible Costs

Nonrecurring Costs

- Installation of emergency service trunks from mobile switching center to selective router
- Signal control point, wireless interface device
- Switch upgrades, hardware, and software
- Engineering
- Accounting
- Legal
 - Nondisclosure agreements
 - 911 contracts
 - Federal or state filings
 - Field technician
 - Interconnect, spans/trunks (to router, SCP, and ALI Database)

Recurring Monthly Costs

- Emergency service trunks from mobile switching center to selective router
- Signal control point, wireless interface device
- Interconnect, spans/trunks (to router, SCP, and ALI Database)
- Switch maintenance, port charges
- Engineering
- Accounting
- Legal
 - Nondisclosure agreements
 - 911 contracts

- Federal and/or state filings
- Database management

Ng 911 network services

NG911 Network Costs

Vendor(s) selected by HSEMD to provide Next Generation 911 network functionality shall be reimbursed for maintaining and upgrading this functionality. This is commonly referred to as next generation core services (NGCS) and includes policy routing, ESInet, cybersecurity, legacy network gateway, location validation function, and border control function, and utilizes National Emergency Number Association (NENA) i3 open standards and interfaces.

Nonrecurring Costs

- Hardware
- Installation
- Network build/enhancements
- Technician costs

Monthly Recurring Costs

- Maintenance
- Statewide GIS
- Statewide aerial photography
- Statewide NG911 core services
- ESInet
- POI

911 Call Processing Equipment Providers

Equipment that is owned by HSEMD functions in a host/remote environment and provides 911 call processing functionality to PSAPs. The equipment includes, but is not limited to, customer premise equipment (CPE), computer aided dispatch (CAD), logging recorders, mapping, and emergency medical dispatch (EMD).

Nonrecurring Costs

- Hardware/software
- Installation
- Technician fees

Monthly Recurring Costs

- Maintenance

911 Call Transport Providers

Vendor(s) that are selected by HSEMD to deliver aggregated 911 traffic to the NGCS call logic centers (CLC), and from the CLCs into the PSAP, are the ESInet provider.

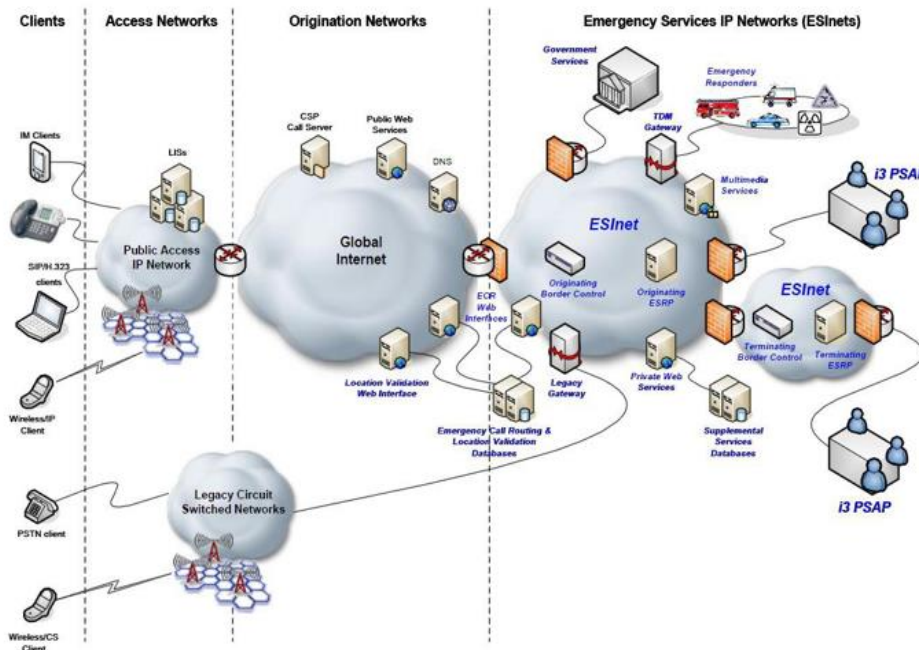

Nonrecurring Costs

- Hardware/software
- Installation
- Network build/enhancements
- Technician fees

Recurring Monthly Costs

- Maintenance
- Circuit costs

ALI Providers

Local exchange service ALI database providers and third party ALI database providers shall be reimbursed for their costs in operating the selective routing and ALI database components of the wireless 911 network as is specified in Iowa Code Chapter 34A. Providers shall request reimbursement for expenses incurred in the previous calendar quarter from the 911 program manager no later than the 20th day following the close of the calendar quarter. Requests for reimbursement received after the 20th day following the close of the calendar quarter will not be eligible for reimbursement in that quarter. The reimbursement request must include a breakout of the costs with original invoices and use the above eligible cost list and the Reimbursement Request Form. _____

Nonrecurring Costs

- Selective router provisioning
- Database setup

Recurring Monthly Costs

- Selective router functionality
- Database records

GIS Grants

The program manager may provide grants to 911 service boards and Department of Public Safety PSAPs. Starting in FY 2019, GIS grants will use an incentive-based approach to award funds based on the quality of data submitted by local 911 service boards. If the data meets benchmarks and frequency as laid out annually by the program manager, the GIS grant will be awarded to the 911 service board. Once received by the local 911 service board, the grants may be used for any purpose under the authority of Iowa Code Chapter 34A.

Catastrophic Reserve

In case of a catastrophic failure to the network, the Iowa General Assembly created a reserve fund. The fund total is 12.5 percent of annual revenues of the Emergency Communications Service Surcharge. HSEMD would use this fund to quickly restore 911 service in case of a catastrophic failure. The failure could necessitate equipment replacement or a repair stemming from a manmade or natural disaster. Expenditure of the fund is at the determination of the HSEMD director. The fund does not accumulate year to year. However, for the purposes of the operating surplus, 12.5 percent of the surcharge generated annually is not eligible for pass-through to local 911 service boards at the end of the fiscal year.

Physical Consolidation Grants

Iowa Code Chapter 34A describes physical consolidation as two or more PSAPs consolidating all PSAP functions, 911 service areas, and physical facilities resulting in the consolidated PSAP being responsible for all call answering and dispatch functions for the combined 911 service area. In short, this means two or more PSAPs combine into something less than what existed prior to the consolidation.

In an effort to encourage PSAP consolidation, the Iowa General Assembly created physical consolidation grants. Grants are available for each PSAP involved for up to \$200,000 or half of the associated costs of the consolidation (whichever is less). Grants are available until June 30, 2022, or as long as funding exists.

Consolidation grants are a one-time grant. A PSAP is only eligible for the grant once per consolidation effort. If a PSAP engages in multiple disparate consolidation efforts, it may be eligible for multiple grants.

Local 911 service boards/PSAPs wishing to consolidate and apply for a grant can access the Iowa 911 Grants online application [form](#). Grants are available throughout the year. Upon completion of the consolidation effort, grant funding is provided to the local 911 service board. Once the consolidation is complete, the 911 service board is provided surcharge according to the number of PSAPs within its area of responsibility (see Joint 911 Service Boards and the Iowa Department of Public Safety earlier in this section).

Eligible grant funds may only directly reimburse expenses associated with the receipt and disposition of the 911 call, as outlined in this chapter. Local match funds, however, can include components of the project deemed ineligible for surcharge expenditures.

PSAPs and 911 service boards applying for consolidation grants must request to appear on the 911 Council agenda and receive approval from the 911 Council.

Public Awareness, Educational Programs, and 911 Council Travel

The general assembly has approved an annual allotment of \$100,000 from the operating surplus for the development of public awareness and educational programs related to public use of the 911 system. Specifically, the approved allotment allows for educational programs for personnel responsible for the maintenance, operation, and upgrading of local 911 systems, and the expenses of members of the 911 Communications Council. All requests for funds under this section must appear on the 911 Council agenda, and receive approval from the council.

Organizations may apply for funds by accessing the Iowa 911 Grants online application [form](#) (also provided as Appendix A of this document).

Entities seeking reimbursement for public awareness educational programs must complete and submit the Attachment B Invoice Form to the program manager.

In 2017, HSEMD, along with the 911 Council, approved a policy for the use of the funds. This policy is included as Appendix B.

Remaining Pass-through funds

At the end of the fiscal year, if funds remain in the emergency communications service surcharge after all above priorities have been funded, the 911 program manager will split the remaining annual surcharge equally, based on the number of PSAPs, to each local 911 service board. Funds are eligible to be used for costs related to the receipt and disposition of 911 calls (as spelled out by the Iowa Code, Iowa Administrative Code, and this plan) and includes access to the state's interoperable communications system. The amount available for pass-through excludes the 12.5 percent reserved for catastrophic failure.

Operational Processes

The 911 program is unique due to its reliance on the private sector. Without close coordination and cooperation, providing 911 service would be impossible. This section provides a high-level overview of general responsibilities to better facilitate those roles in the public-private partnership. Attritional information regarding detailed responsibilities can be found in the service contracts and service level agreements and is available through HSEMD.

HSEMD

One of HSEMD's charges is to oversee and manage the network delivering 911 calls to the PSAPs. This includes managing contractual relationships with vendors providing Next Generation core services, network transport, and shared PSAP services. HSEMD has the ability to order the integration of originating service providers (ILEC/LEC/CLEC/wireless providers) into the Next Generation 911 environment. Further, HSEMD orders and maintains necessary circuits with the 911 call transport provider for connectivity to and from the wireline aggregation points to the CLCs and to the PSAPs. During outages, or in advance of maintenance windows, HSEMD provides notification to all impacted parties. Finally, the 911 program manager consults with the 911 Communications Council regarding items of interest impacting 911 in Iowa and items as prescribed in Iowa Code Chapter 34A.

Manage the Network

- HSEMD is tasked throughout Iowa Code Chapter 34A for network design and maintenance, along with ensuring all 911 call delivery is within industry standards (NENA i3). This

includes working with the following partners to ensure a seamless 911 call with all pertinent call data from originating caller to the PSAP:

- Originating service providers
- 911 call transport provider
- 911 call processing equipment providers
- Next Generation 911 network service provider
- PSAPs
- Other equipment vendors as needed

Maintain and Oversee the Shared Services Environment

The shared services environment was implanted beginning in 2018 through HF2254. It allows PSAPs to remotely access a state-owned host call-handling system. It is a more cost effective way for local PSAPs to achieve the same level of functionality.

- Order and maintain necessary circuits through the 911 call transport provider to support the 911 call processing equipment provider and the state's shared service environment.
- Develop and maintain [Notice of Interest/Initial Intake Form](#) as well as sign a user agreement outlining roles, responsibilities, and terms of participation.
 - HSEMD will fund the CPE-related costs for PSAPs/local service boards that wish to participate in the shared services environment through the Emergency Communications Service Surcharge.
 - HSEMD will cost-share additional services and functionality of the shared services environment with the local 911 service board/PSAPs who opt into the available services and functionality.

Manage the Network Change Request Process

- The change management policy is maintained via an online request form on HSEMD's website, available [here](#). Change management provides understanding of a proposed request for change (RFC) and the effects of the RFC on the Iowa wireless 911 network, local agencies, and end users.
- The change management process centralizes the approval and disapproval for all wireless 911 network-related activities, such as the addition, removal, or modification of the following:
 - Software
 - Hardware (including shared service installation/modifications)
 - Service components
 - Associated documentation that could potentially impact wireless 911 call delivery

- HSEMD maintains and processes all change management activities. All change requests must utilize the change management process.

Originating Service Providers

Originating service providers are defined in Iowa Code Chapter 34A as a communications provider that allows its users or subscribers to originate 911 voice or nonvoice messages from the public to public safety answering points, including, but not limited to, wireline, wireless, and voice over IP services. In Iowa, this includes the more than 150 independent local exchange carriers as well as wireless service providers.

- Upon notification from the 911 program manager, originating service providers (OSPs) are responsible for integrating into the Next Generation network at the appropriate point of interface (POI).
 - For wireline exchange carriers, the point of connection is at the aggregation points managed by the ICN throughout the state.
 - Wireless service providers send Signaling System 7 (SS7) messaging to the call logic centers (CLCs) in West Des Moines and Davenport for initial 911 call set up.
 - OSPs must work with the ICN and Comtech to ensure successful and timely connectivity.
 - Costs associated with these integrations are eligible expenses under Iowa Code Chapter 34A (see section 3 and 4 of the Eligible Costs chapter).
- In cases of service impairment, OSPs shall provide notification as required by the Iowa Utilities Board and the FCC.

911 Call Transport Provider (ICN)

Call transport providers for 911 are defined in Iowa Code Chapter 34A as a vendor selected by HSEMD to deliver aggregated wireline 911 call traffic to the Next Generation 911 network and from the Next Generation 911 network to the public safety answering points. HSEMD has selected the Iowa Communications Network to be the 911 call transport provider. The call transport provider must:

- Monitor the ICN network 24 hours per day, seven days per week, utilizing a centralized control center for real-time status and alarm conditions on certain network elements
- Dispatch technicians when the network experiences failures, troubles, or equipment degradation
- Process support requests for incident resolution and escalation
- Provide notification of service impairments
- Provide client notification regarding outages and maintenance

- Provide network redundancy
- Provide circuits with adequate bandwidth as requested by HSEMD
- Coordinate with LECs for transport of wireline 911 services to aggregation points
- Manage aggregation points for LEC and transport the traffic to CLC POI

Next Generation 911 Network Service Provider (Comtech TCS)

Iowa Code Chapter 34A defines the NG911 network service provider as the vendor selected by HSEMD to provide Next Generation 911 network functionality. In 2011, HSEMD entered into a contract with Comtech TCS to provide Next Generation 911 core services as further defined below.

- Provide Next Generation 911 core services in accordance with the contract, scope of work, and service level agreement
- Continuous availability and monitoring of systems, seven days per week, 365 days per year
 - Maintain two network operations centers (NOC)
 - Monitor all critical production applications
 - Provide identification, troubleshooting, internal and external notification of incidents, incident management, and problem resolution
 - Track call origination, call completion, call control message, and data delivery
 - Develop comprehensive disaster recovery plan
 - Monitor the telephony and database connections, all hardware connections, and software used by the system or interconnected systems
 - Develop operational procedures and work cooperatively with personnel from HSEMD, 911 network transport provider, PSAPs, wireless service providers, and 911 call processing equipment provider
- Respond directly to PSAP or vendor requests for trouble tickets or issues with 911 calls
 - Review all tickets on the day they are received and work to resolution
 - Respond to system failure reports within 15 minutes of notification and pursue corrective action within one hour of notification, 24 hours per day, 365 days per year.
- Provide and maintain secondary ESInet
 - Provide notification of service impairments

911 Call Processing Equipment Provider (Zetron)

Iowa Code Chapter 34A defines the 911 call processing equipment provider as the vendor selected by HSEMD to provide 911 call processing equipment. By definition, the 911 call processing equipment is owned by HSEMD and functions in a host/remote environment. It includes, but is not limited to, computer aided dispatch, voice logging recorders, mapping, and emergency medical dispatch. HSEMD has selected Zetron as the provider for call processing equipment in Iowa. The 911 call processing equipment provider is required to:

- Provide oversight and facilitate communication between service providers and the PSAPs
- Provide notification of service impairments
- Ensure the change request process is followed during installation or maintenance of services
- Work in coordination with the NG911 network service provider and the 911 call transport provider
- Respond to all requests for service and installations within the contract scope of work and service level agreement

PSAPs and Joint 911 Service Boards

The accepted definition of a public safety answering point is a 24-hour public safety communications facility that receives 911 service calls and directly dispatches emergency response services or relays calls to the appropriate public or private safety agency. Each county's board of supervisors is responsible for maintaining a joint 911 service board. There are currently 113 PSAPs and 93 joint 911 service boards (92 counties plus the South Central Iowa Regional Service Board, which incorporates the counties of Adair, Adams, Clarke, Guthrie, Madison, Union, and Taylor). PSAPs are required to:

- Provide access to facilities upon request for installation, testing, and maintenance
- Initiate a trouble ticket when service is impaired
- Maintain PSAP conditions in accordance with Iowa Administrative Code § 605.14(2) (minimum operational and technical standards)
- Complete a [Notice of Interest/Initial Intake Form](#) as well as sign a user agreement outlining roles, responsibilities, and terms of participation if they wish to participate in the shared services environment
 - PSAPs opting into a shared service environment will have CPE costs funded by HSEMD through the Emergency Communications Service Surcharge

- Additional services and functionality of the shared services environment will be cost-shared with HSEMD
- The PSAP and the local 911 service board are solely responsible for the standard operating procedures and the operation of the call-taking and dispatch functions for the 911 service area.
- For PSAPs choosing to maintain their own call processing equipment, all equipment must have passed interoperability testing with the NG911 service provider (Comtech TCS) prior to installation.

If the PSAP or their designated equipment vendor damages any of the equipment owned by the state, the responsible PSAP is liable for the replacement cost of the damaged equipment.

Network Design

In 2009, HSEMD began planning for the transition to a Next Generation 911 network utilizing an Internet protocol (IP) backbone to upgrade the wireless 911 network in Iowa. HSEMD contracted with TeleCommunications Systems, Inc. (TCS) to implement an IP-based network to deliver 911 wireless calls to the primary PSAPs within Iowa.

Implementation of the state of Iowa NG911 wireless network began in August 2011. In December 2012 initial implementation was completed establishing design, architecture, and transport functionality of the network. This implementation included 115 (now 113) PSAPs receiving service via the Iowa wireless network. The new IP network creates a framework for the transition to a NENA-i3-compliant network in the future. It allows PSAPs that have not yet upgraded to NG-capable equipment, along with those that have upgraded their equipment, to receive calls, including wireless, VoIP, and telematics via the IP network. Iowa is currently in a transitional phase to full Next Generation 911, but continues to be on the leading edge of adopting technology and capabilities as it becomes available from the private sector.

One of the next transitional steps toward full Next Generation 911 adoption is use of the location validation function (LVF) and emergency call routing function (ECRF) as part of the NGCS with the Next Generation network service provider. Rather than route calls based on tower face and location, routing via LVF/ECRF more accurately routes calls using the NG911 GIS data developed over three to five years.

The following section will detail specific portions of the overall 911 network in Iowa.

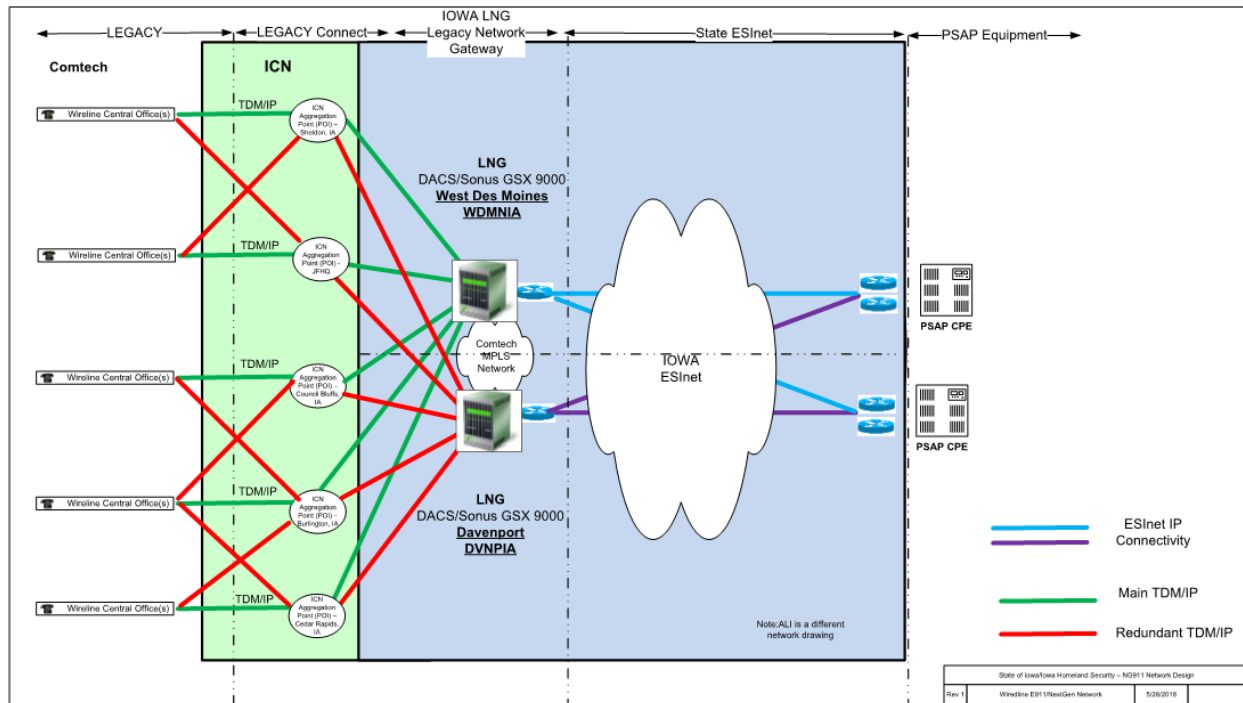

Wireless 911 Network Design

The network initially designed to deliver wireless 911 calls in the state of Iowa is comprised of two geographically diverse call logic centers located in Des Moines and Davenport. These data centers connect to the PSAPs via an IP network, utilizing the Iowa Communications Network wherever available. Wireless service providers send Signaling System 7 messaging to the data centers for initial 911 call set up. The system determines the appropriate PSAP to receive the call and delivers the call via IP circuits.

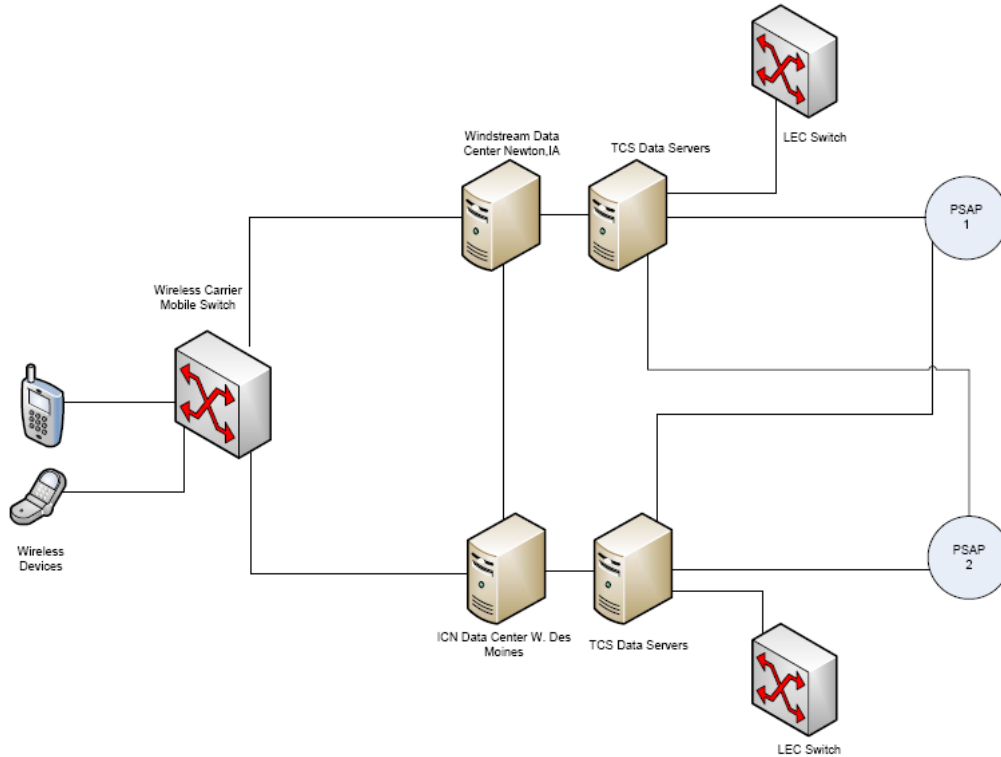

Iowa Wireless Network Final Design

Wireline 911 Network Design

In 2018, the network underwent an expansion to include wireline, as well as wireless, 911. HSEMD contracted with the ICN to coordinate the aggregation of wireline 911 traffic through aggregation points and pass the traffic through to the Next Generation service provider’s call logic center, and via the ESInet route the call to the appropriate PSAP. The wireline traffic is passed to the data center’s point of interface as it is received, either Time Division Multiplex (TDM) over ethernet or Session Initiated Protocol (SIP).

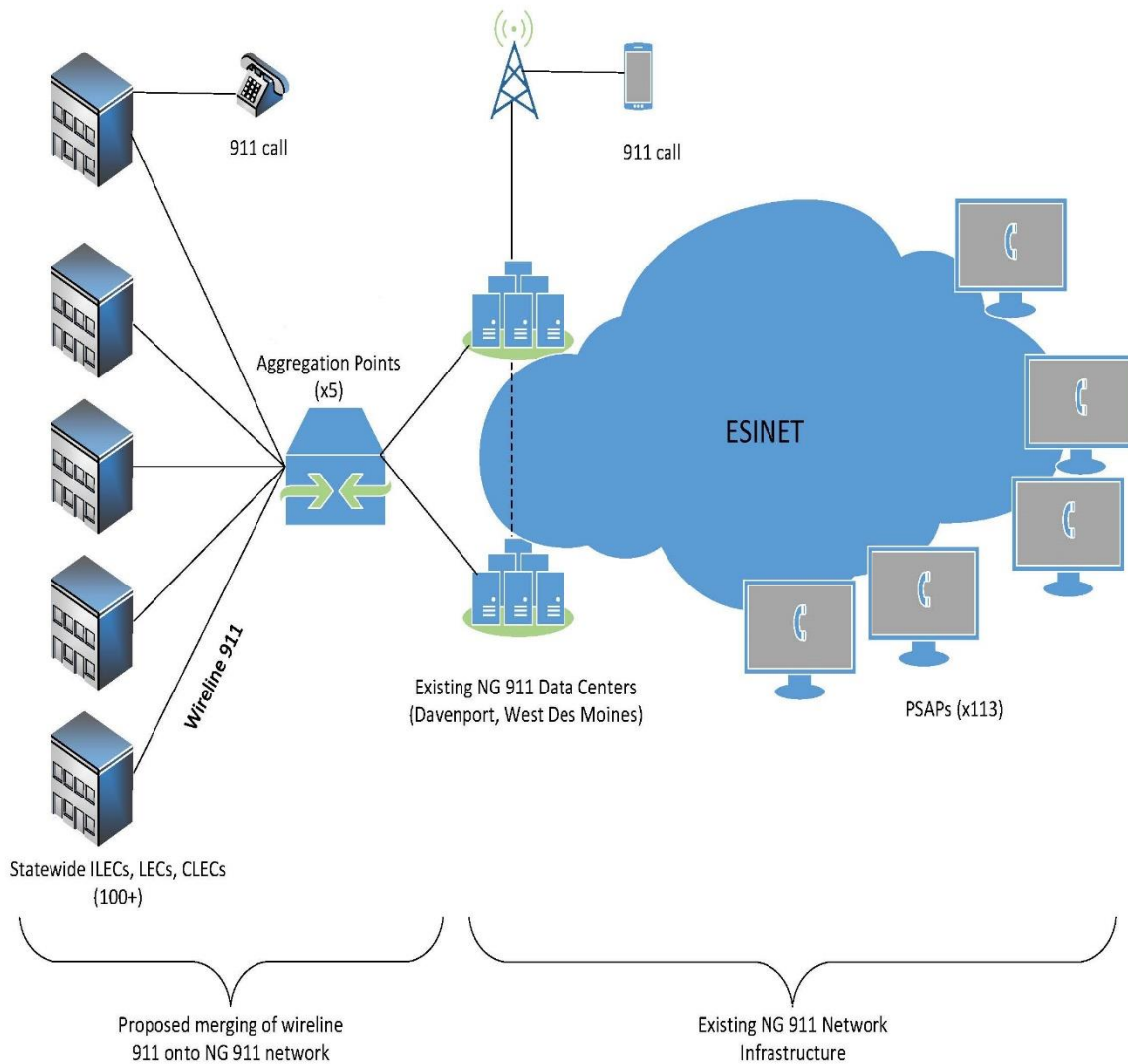

Primary ESInet

The 911 network call transport provider, ICN, provides the backbone of the ESInet through a Multiprotocol Label Switching (MPLS) network. The ICN also provides last-mile PSAP connectivity throughout the state, except in two locations where last-mile connectivity is provided by a third party.

IOWA Next Generation 911 (NG911) Connectivity

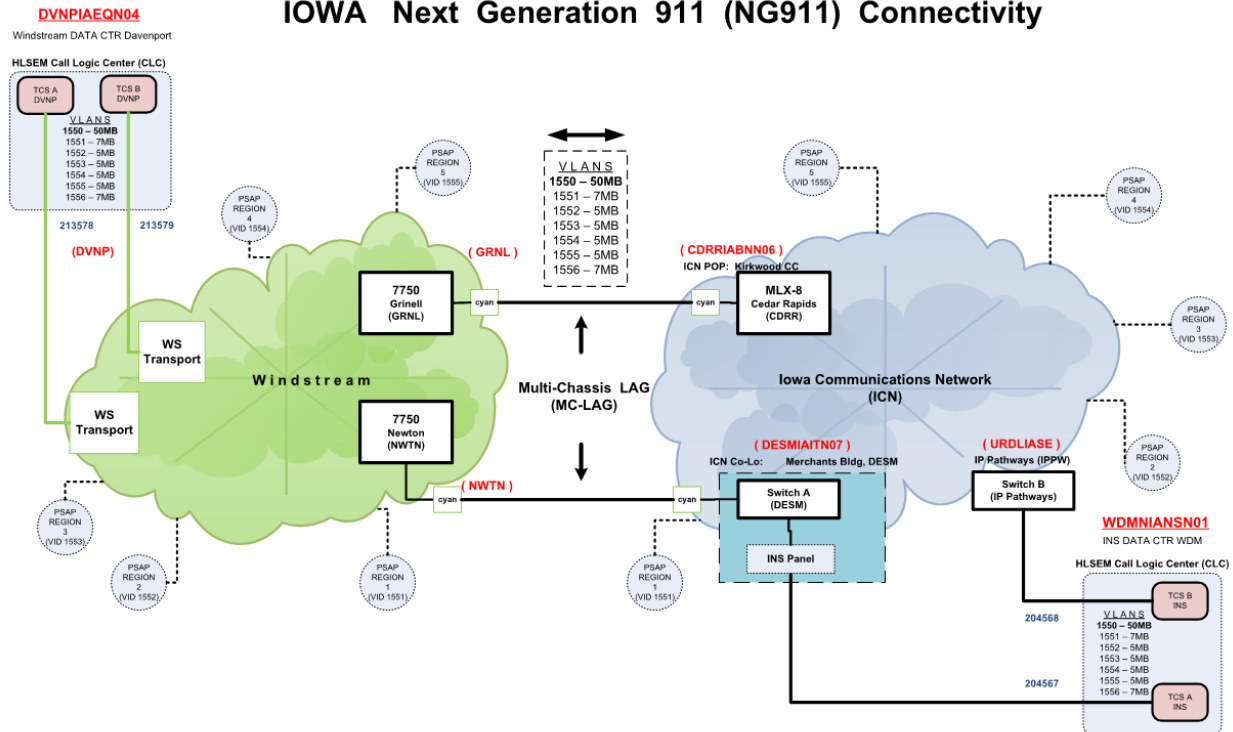

Secondary ESInet

In 2015, HSEMD recognized the need for a completely separate and redundant network. In conjunction with the 911 network services provider, HSEMD began constructing a secondary ESInet. The secondary ESInet will be designed for thirteen counties to provide additional redundancy for the primary network. This network is completely separate from the primary network and is “active-active” meaning calls pass over both the primary and secondary network simultaneously. In the case of one network failing, all calls pass through the functioning network. The PSAPs connected to the secondary ESInet are:

1. Black Hawk County
2. Cedar Rapids Joint Communications Agency
3. Des Moines Police Department
4. Dickinson County
5. Dubuque County
6. Johnson County*
7. Iowa Department of Public Safety-Joint Forces Headquarters, Johnston
8. Lee County
9. Polk County Sheriff’s Office
10. Pottawattamie County
11. Scott County/Davenport Police Department
12. Westcom*

13. Woodbury County

* Not yet installed

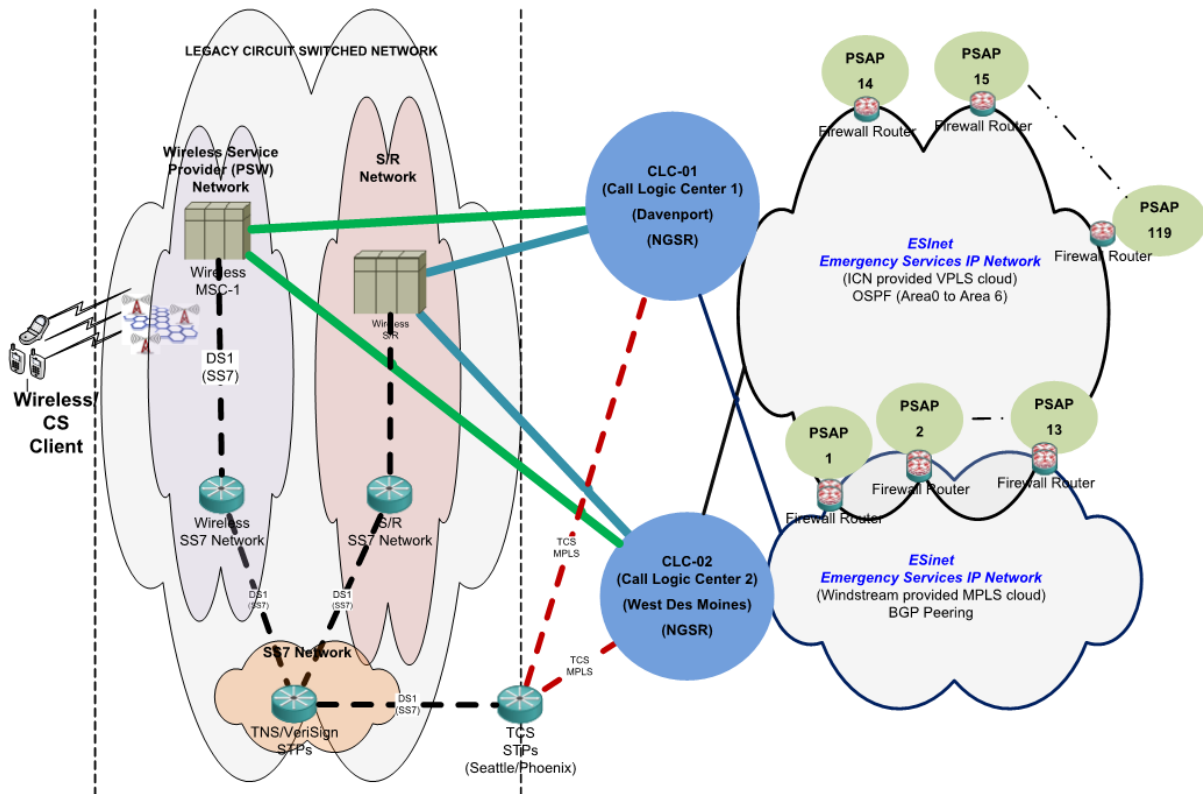

PSAP Connectivity

The vast majority of PSAPs in Iowa have CPE configured to receive calls via SIP messaging. For the PSAPs that have not migrated to SIP, the Next Generation 911 network service provider places a legacy PSAP gateway (LPG) in order to convert the IP calls back to analog, enabling the CPE to handle the call. Once PSAPs have upgraded their CPE, the LPG is removed and the PSAP will receive the calls via SIP messaging.

Text to 911

As of 2018, all PSAPs are capable of receiving text to 911 (SMS or short message service). Once wireless providers are able to transmit photos and video (MMS or multimedia messaging service) to 911, the network will be fully capable of handling the data. CPE upgrades may be required at the PSAPs in order to view MMS messages.

NG911 GIS Guidelines

The Iowa 911 Program will use the following guidelines and criteria to evaluate GIS data remediation and ongoing maintenance. The county joint 911 service board will be required to submit the following information and certify compliance.

Accurate GIS data is a critical component of Next Generation 911. GIS data will be used to validate the location of emergency calls and also to route the emergency calls to the proper PSAP. As a result, the preparation and ongoing maintenance of GIS data for use in NG911 must be undertaken by qualified and competent local government staff and/or vendors.

Standards

HSEMD, in cooperation with the Iowa NG911 Advisory Committee and GeoComm, Inc., have developed an NG911 GIS data standard to provide a solid foundation for NG911 GIS dataset development in the state of Iowa. At its core, the standard follows the NENA standard for [NG911 GIS data model](#). The adopted standards are located on the HSEM website.

Compliance

The local 911 service board and/or its contractor will remediate all deficiencies identified by its latest GIS quality assurance/quality control reports completed by GeoComm, Inc. Each board or its contractor must upload its mandatory (see Standards section) authoritative data twice each year. The minimum GIS data accuracy, based on submitted GIS data, must be between 95-98 percent, including the synchronization results between the GIS data and the 911 databases (ALI and MSAG). In the event that a county has not submitted at least twice per year and/or their accuracy is less than 95 percent, HSEMD will notify the county joint 911 service board and/or the board's contractor of the remaining deficiencies. Local 911 service boards not meeting the criteria laid out in the standards may be ineligible to receive GIS grant funding.

ATTACHMENTS

Following this page are the attachments and maps used by the 911 program.

- [Attachment A – Invoice \(to be used by vendors\)](#)
- [Attachment B – Invoice \(to be used by counties\)](#)
- Attachment C – (Reserved—No longer in use)
- [Attachment D – Change Management Request Form](#)
- [PSAP Listing by County](#)
- County 911 Service Area Maps
- [Appendix A – 2019 911 Grant Applications](#)
- [Appendix B – Policy for Use of Public Awareness Funds](#)

COUNTY 911 SERVICE AREA MAPS

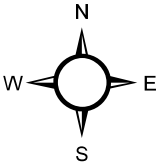

Adair County

Greenfield, Iowa

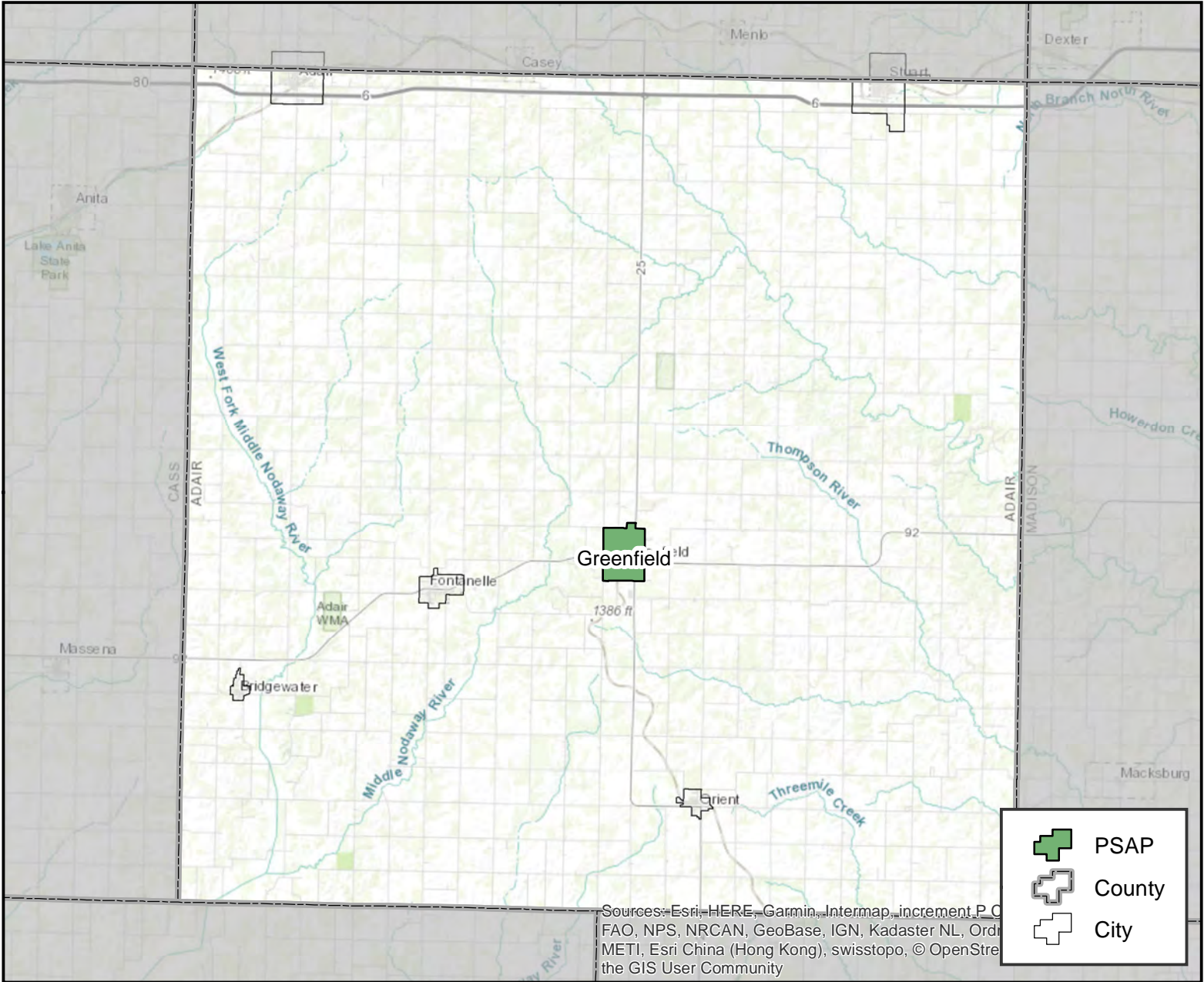

PSAP Information

Adair County Sheriff's Office
FCC #: 1890
Phone #: 641-743-2148
302 E Iowa St Greenfield, IA 50849

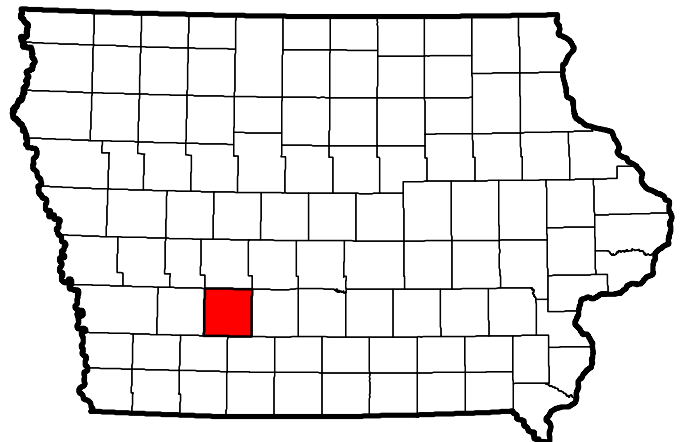

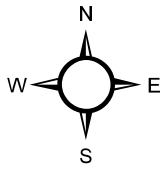

Adams County

Corning, Iowa

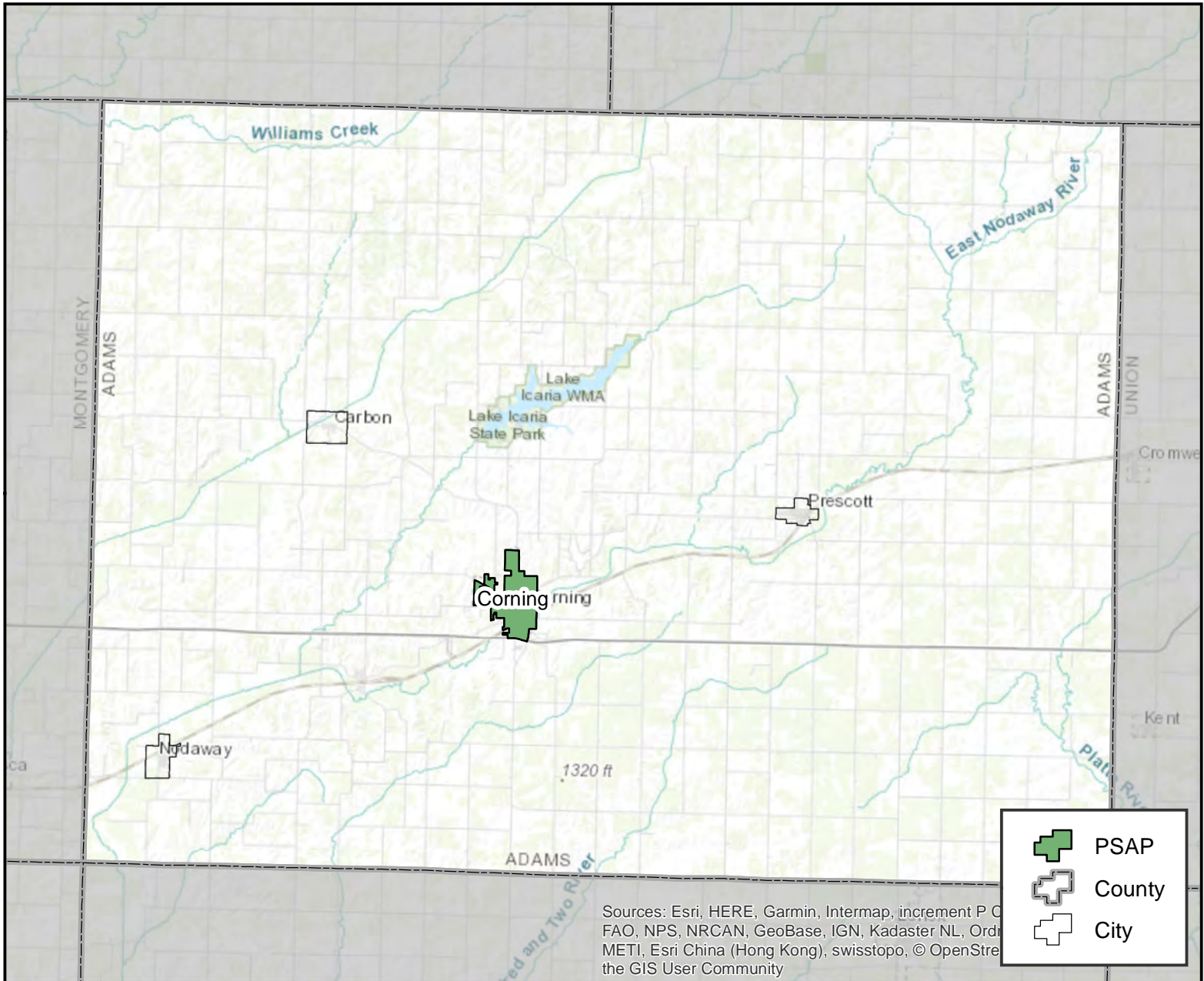

PSAP Information

Adams County Sheriff's Office
FCC #: 1891
Phone #: 641-322-4444
901 Davis Ave Corning, IA 50841

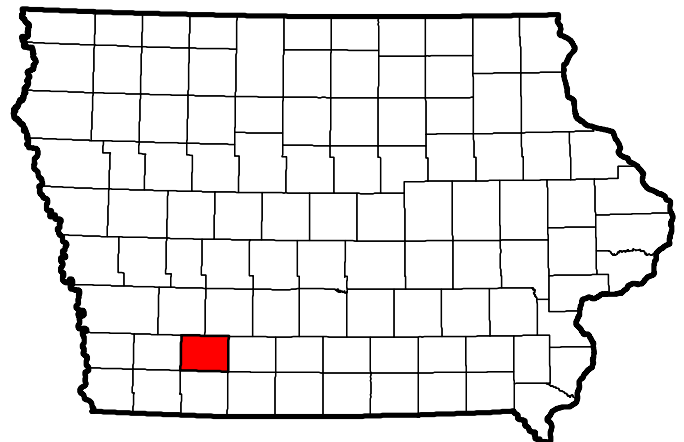

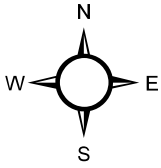

Allamakee County

Waukon, Iowa

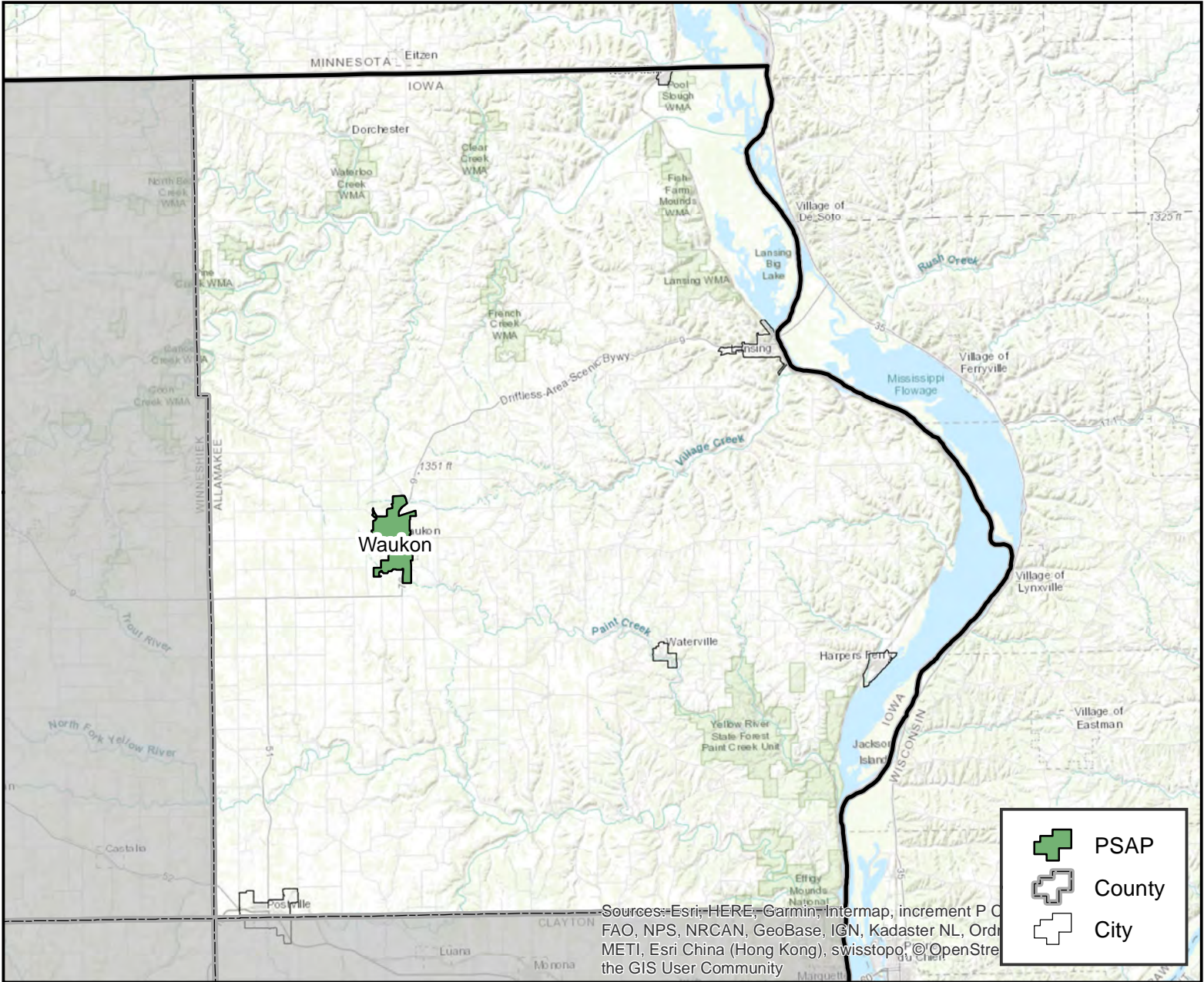

PSAP Information

Allamakee County Sheriff's Office
FCC #: 1893
Phone #: 563-568-4521
877 Hwy 9, Waukon, IA 52172

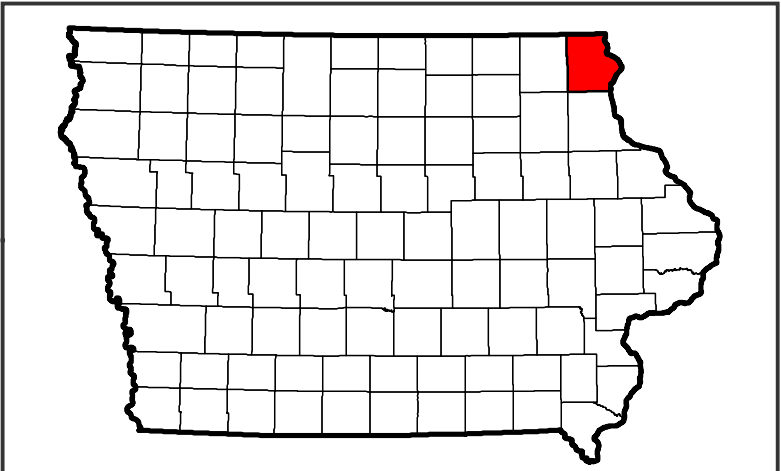

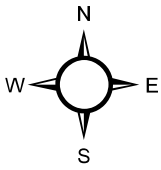

Appanoose County

Centerville, Iowa

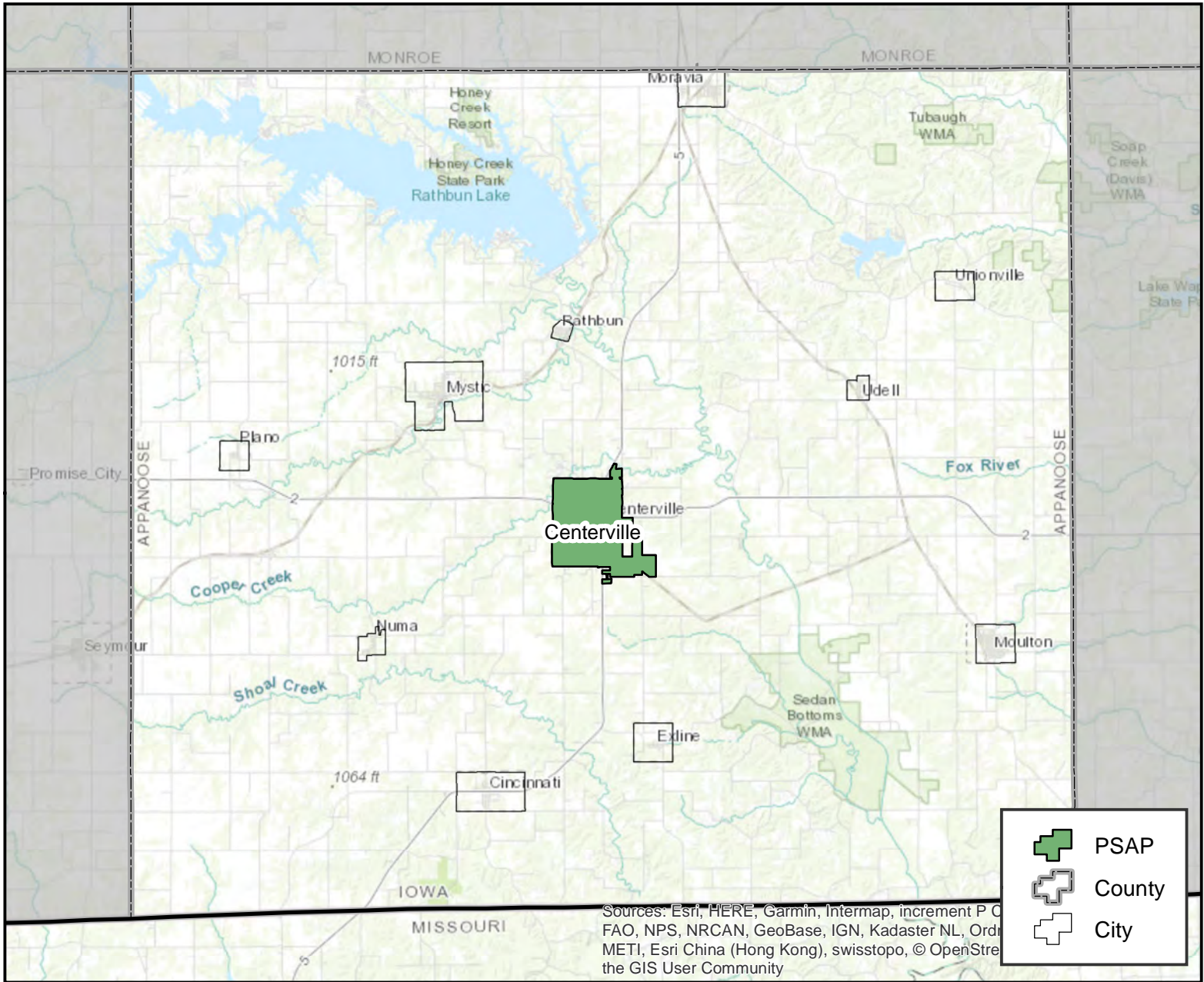

PSAP Information

Appanoose County Sheriff
FCC #: 1896
Phone #: 641-437-7100
1125 W. Van Buren Street Centerville, IA 52544

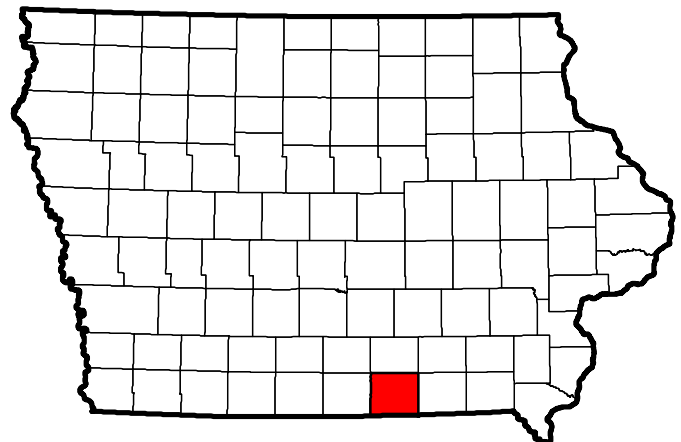

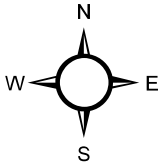

Audubon County

Audubon, Iowa

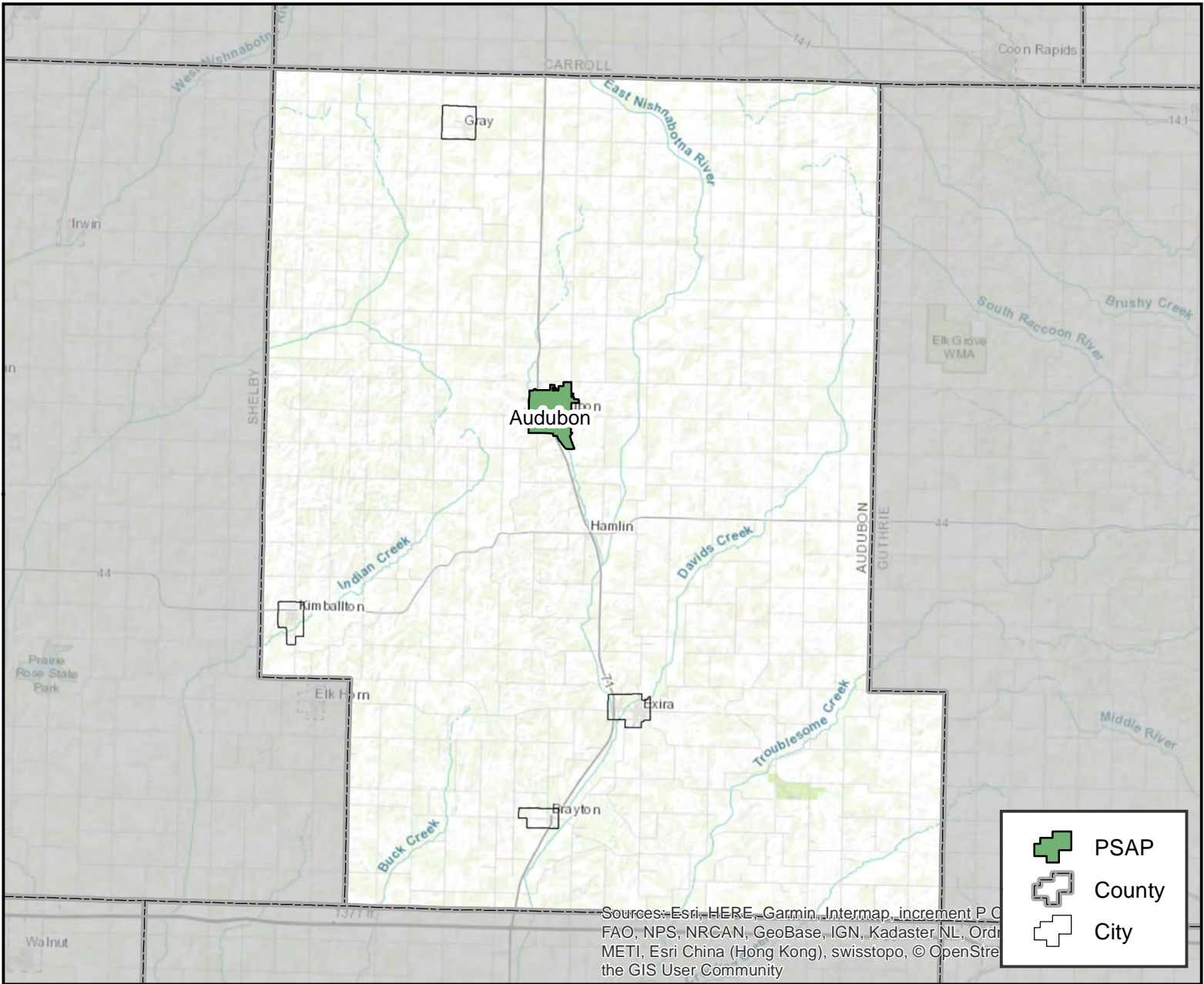

PSAP Information

Audubon County 911 Communications
FCC #: 1899
Phone #: 712-563-2631
318 Leroy St. Audubon, IA 50025

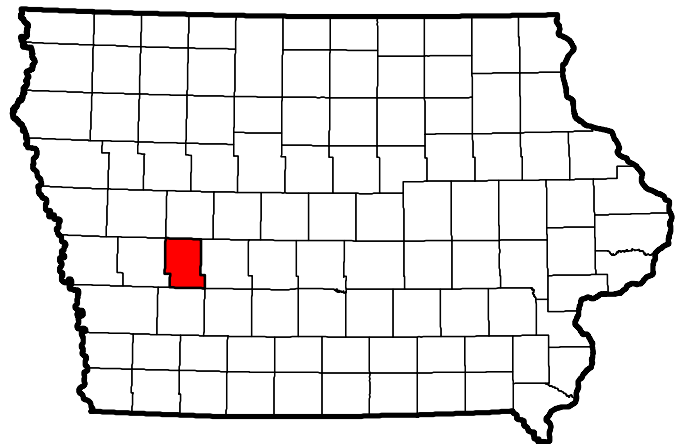

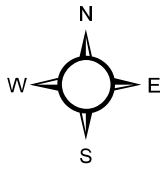

Benton County

Vinton, Iowa

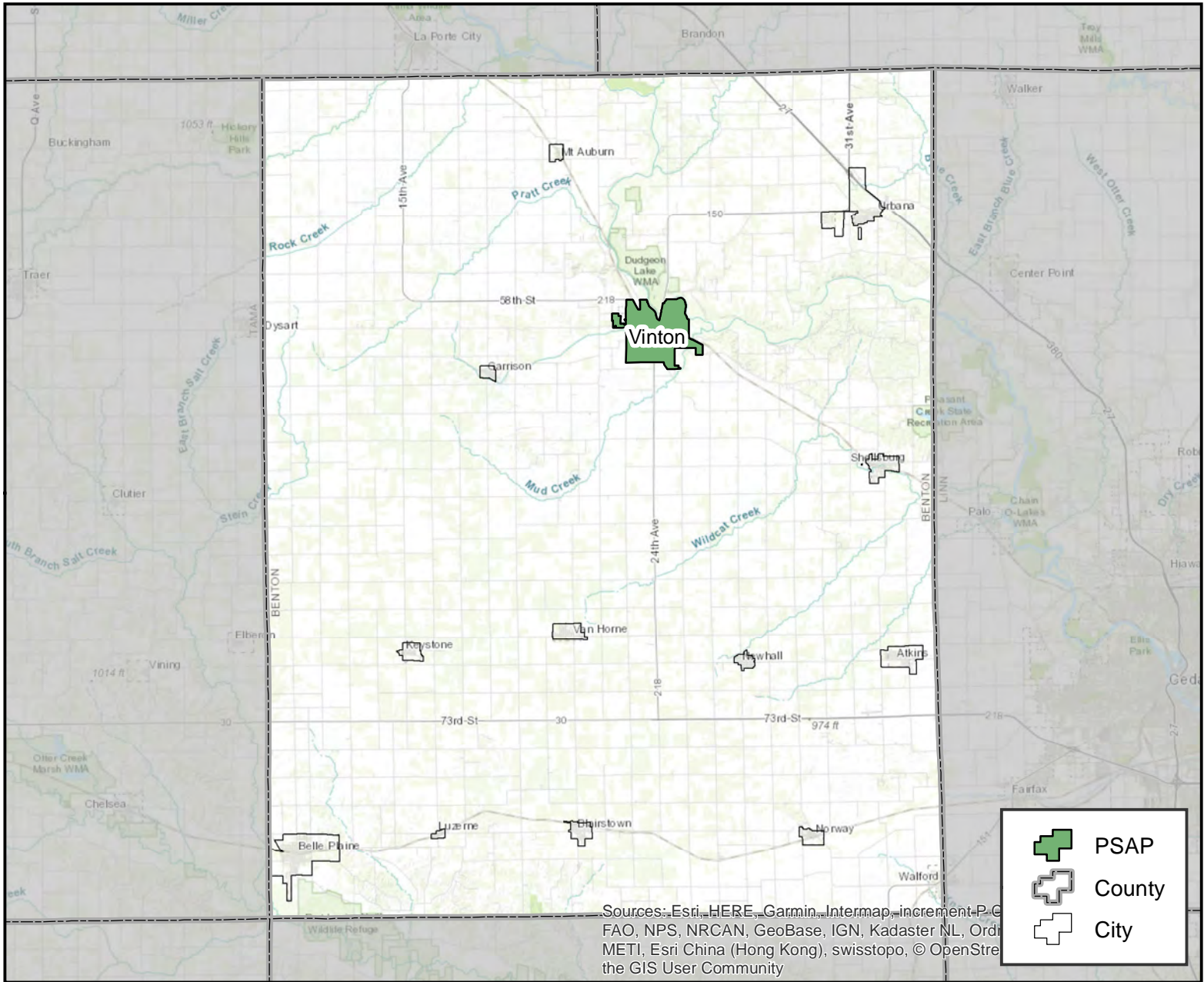

PSAP Information

Benton Co Sheriffs Office
FCC #: 1900
Phone #: 319-472-2337
113 East 3rd Street Vinton, IA 52349

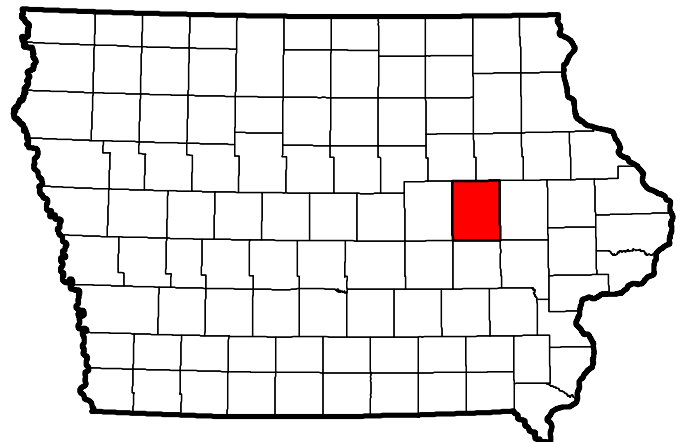

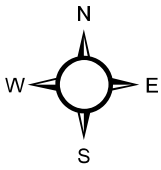

Black Hawk County

Waterloo, Iowa

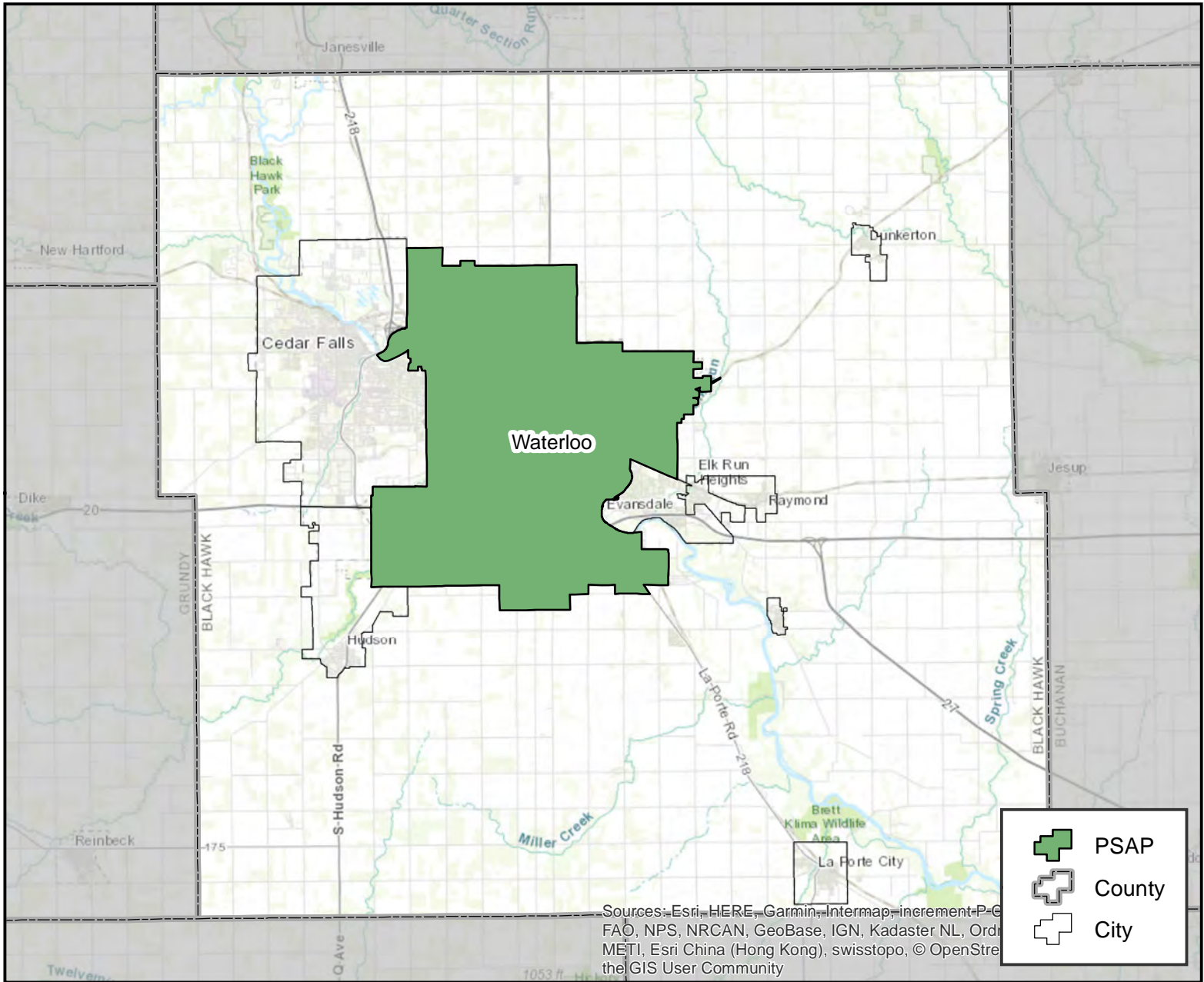

PSAP Information

Black Hawk Consolidated Communications Center
FCC #: 1902
Phone #: 319-291-2515
225 E 6th Street Waterloo, IA 50703

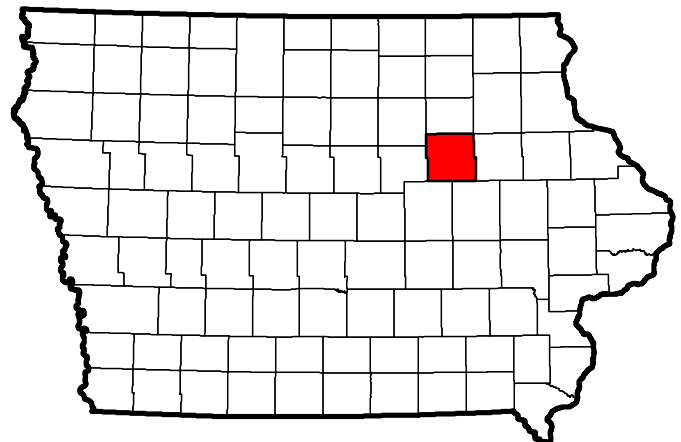

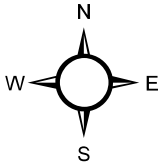

Boone County

Boone, Iowa

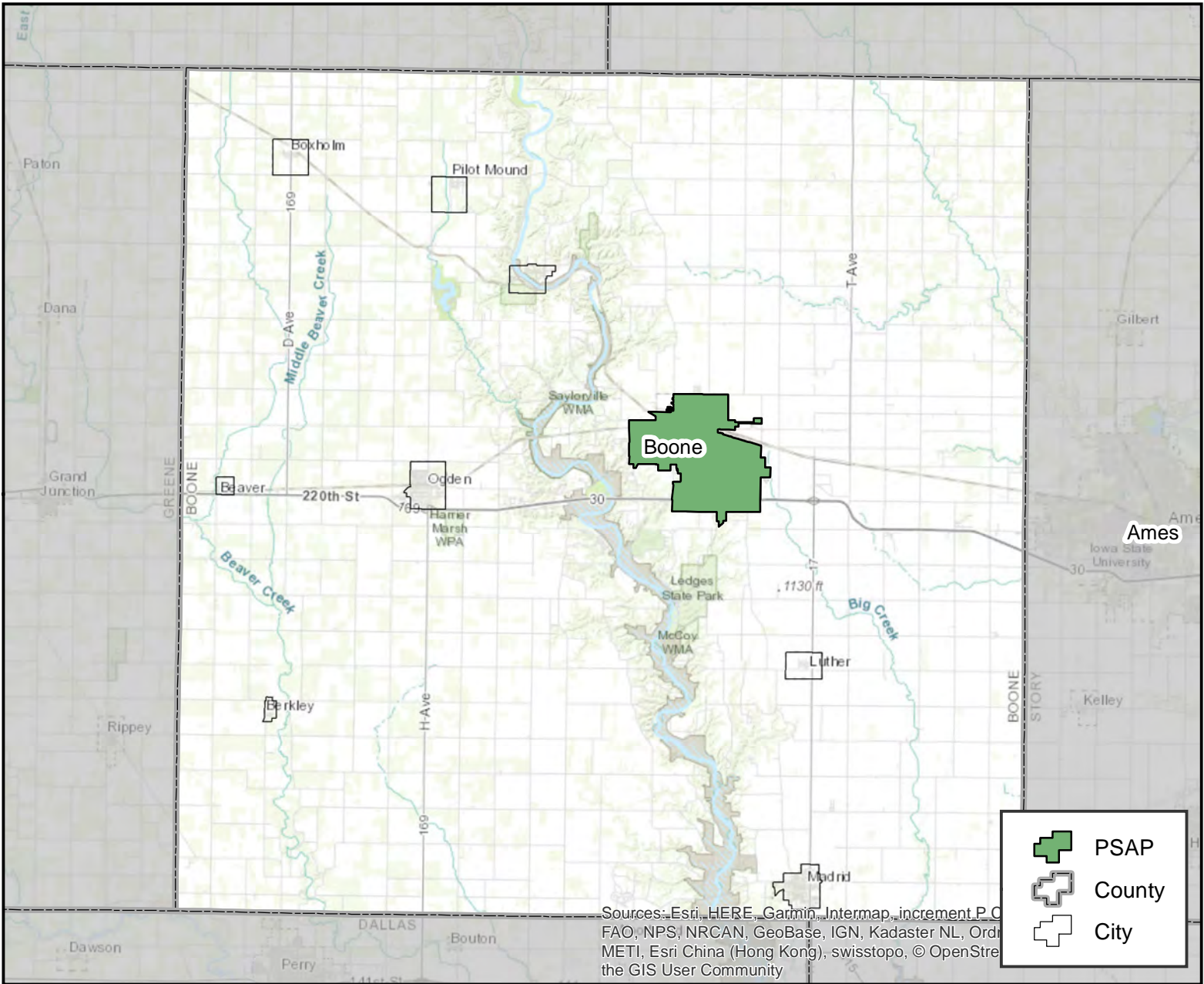

PSAP Information

Boone County Communications

FCC #: 1903

Phone #: 515-433-0524

1019 W. Mamie Eisenhower Boone, Iowa, IA 50036

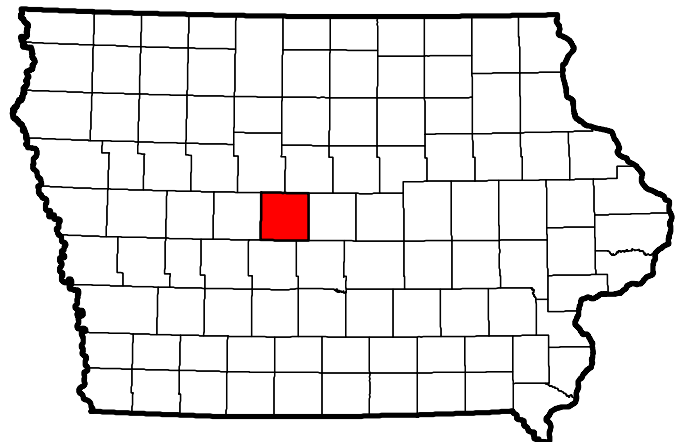

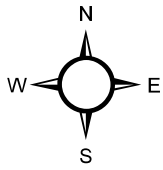

Bremer County

Waverly, Iowa

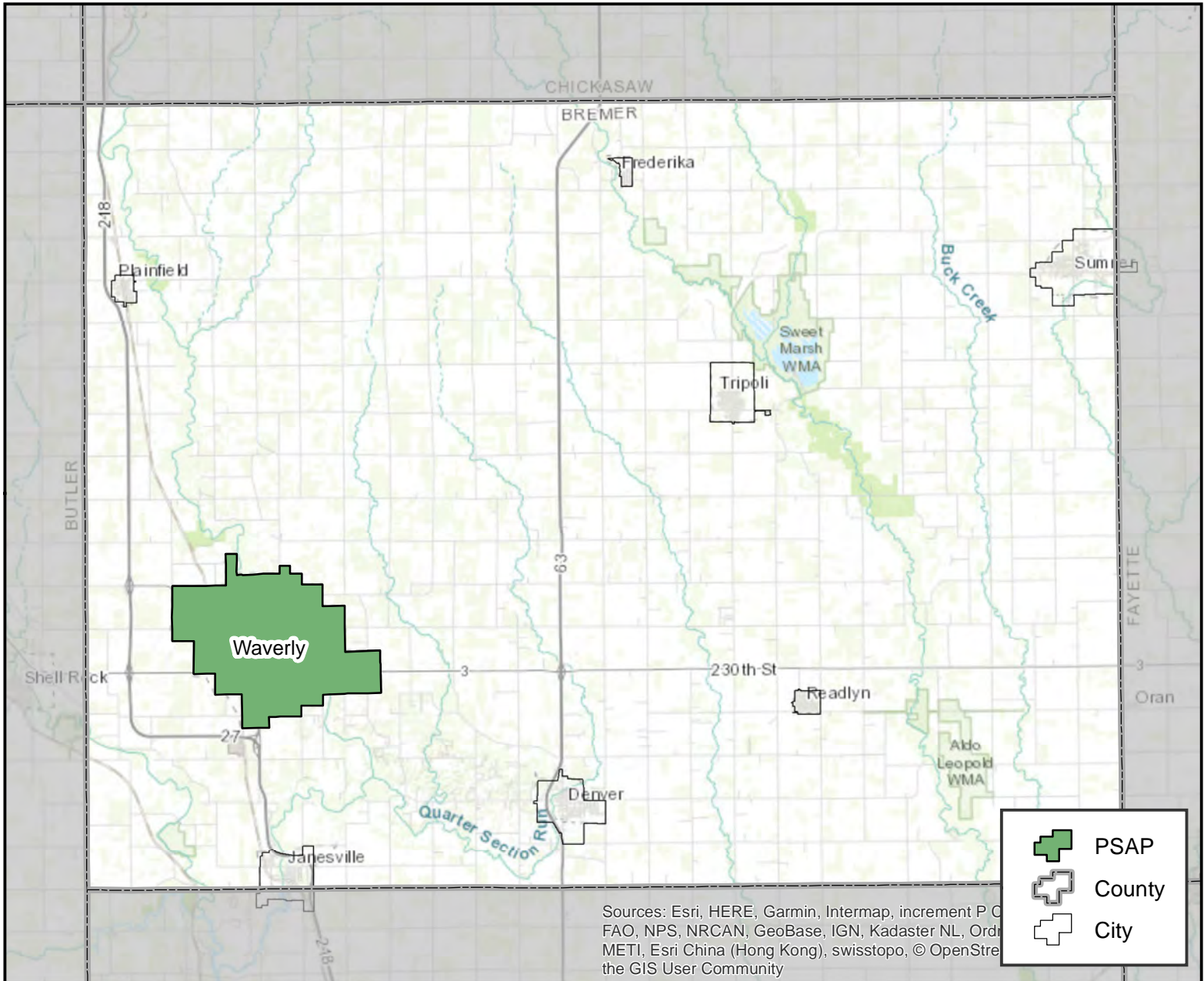

PSAP Information

Bremer Co- Waverly Law Center
FCC #: 1904
Phone #: 319-352-5400
111 4th St NE Waverly, IA 50677

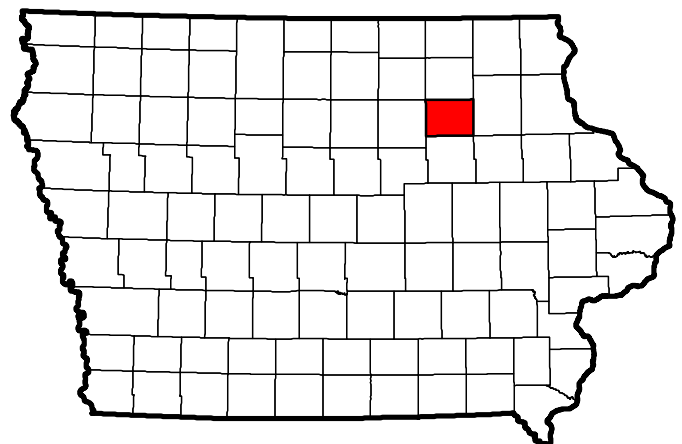

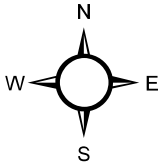

Buchanan County

Independence, Iowa

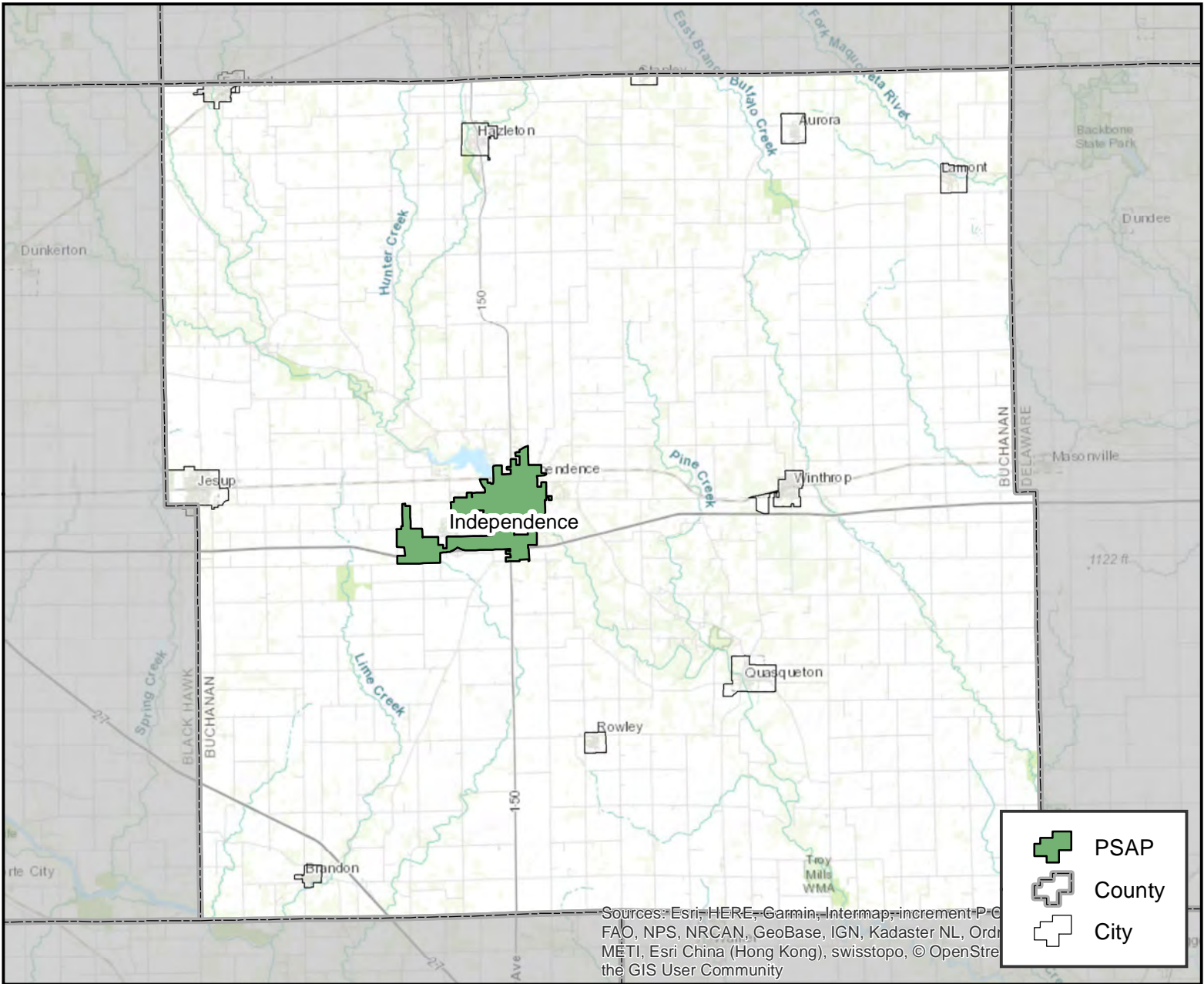

PSAP Information

Buchanan County Sheriff
FCC #: 1905
Phone #: 319-334-2567
210 5th Avenue NE Independence, IA 50644

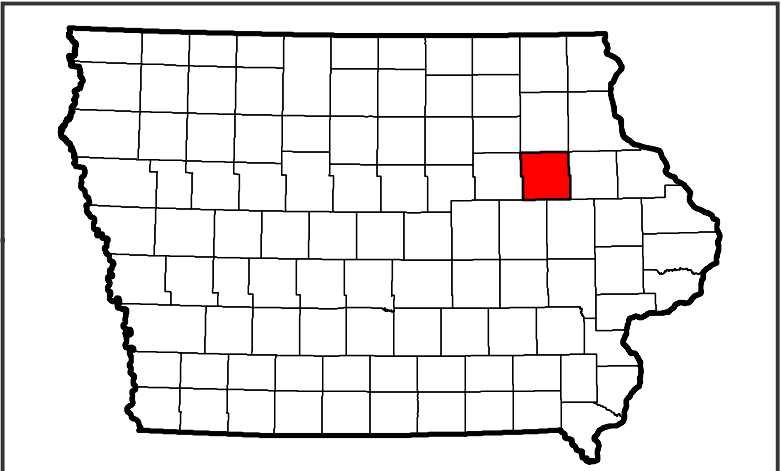

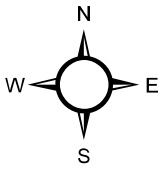

Buena Vista County

Storm Lake, Iowa

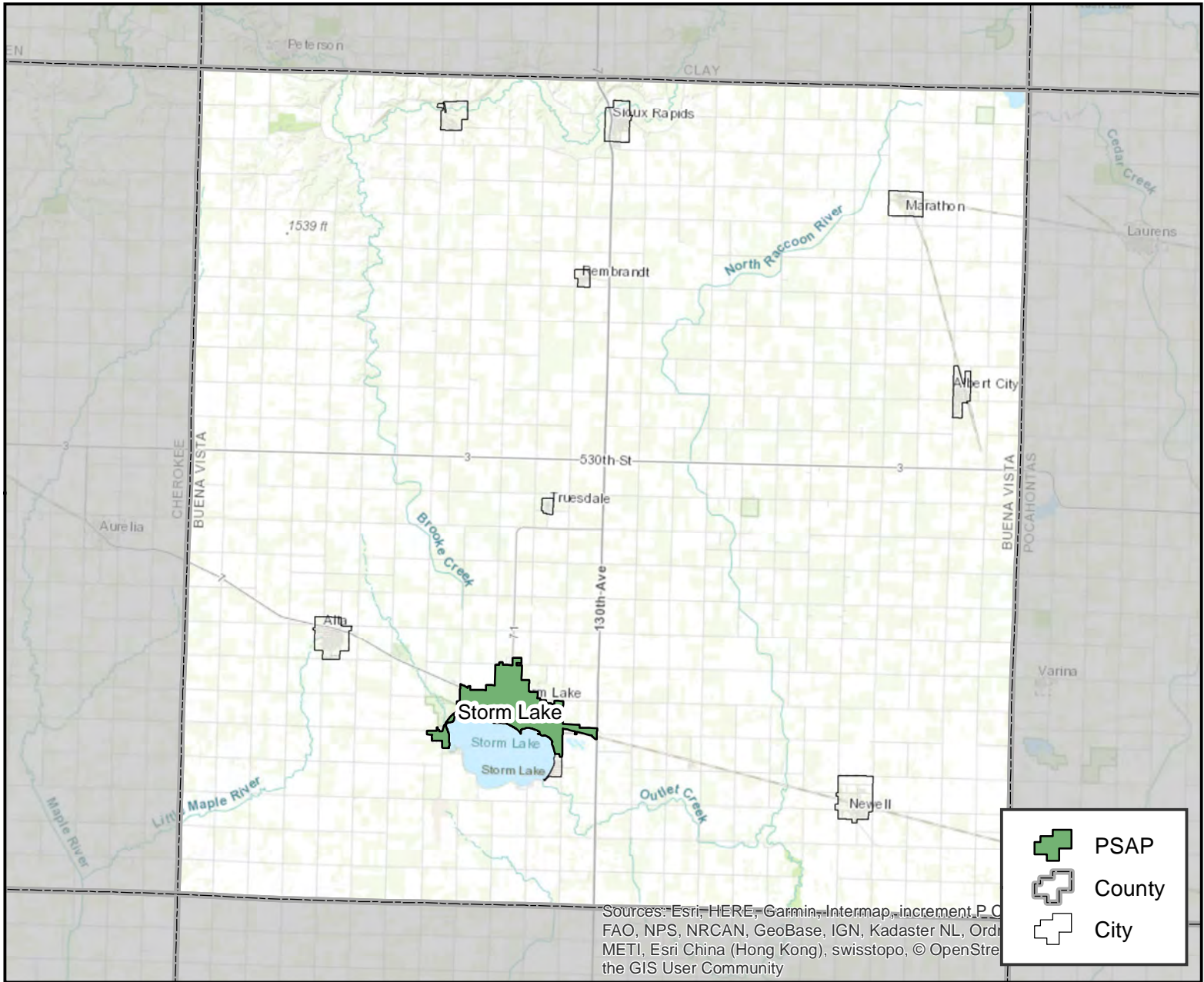

PSAP Information

Buena Vista County 9-1-1 Communications Center-Storm Lake
FCC #: 1906
Phone #: 712-749-2525
411 Expansion Blvd Storm Lake, IA 50588

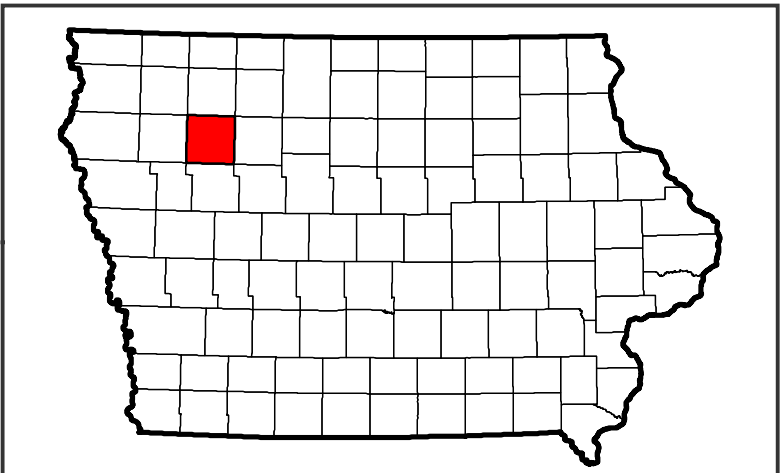

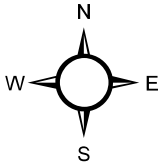

Buena Vista County

Storm Lake, Iowa

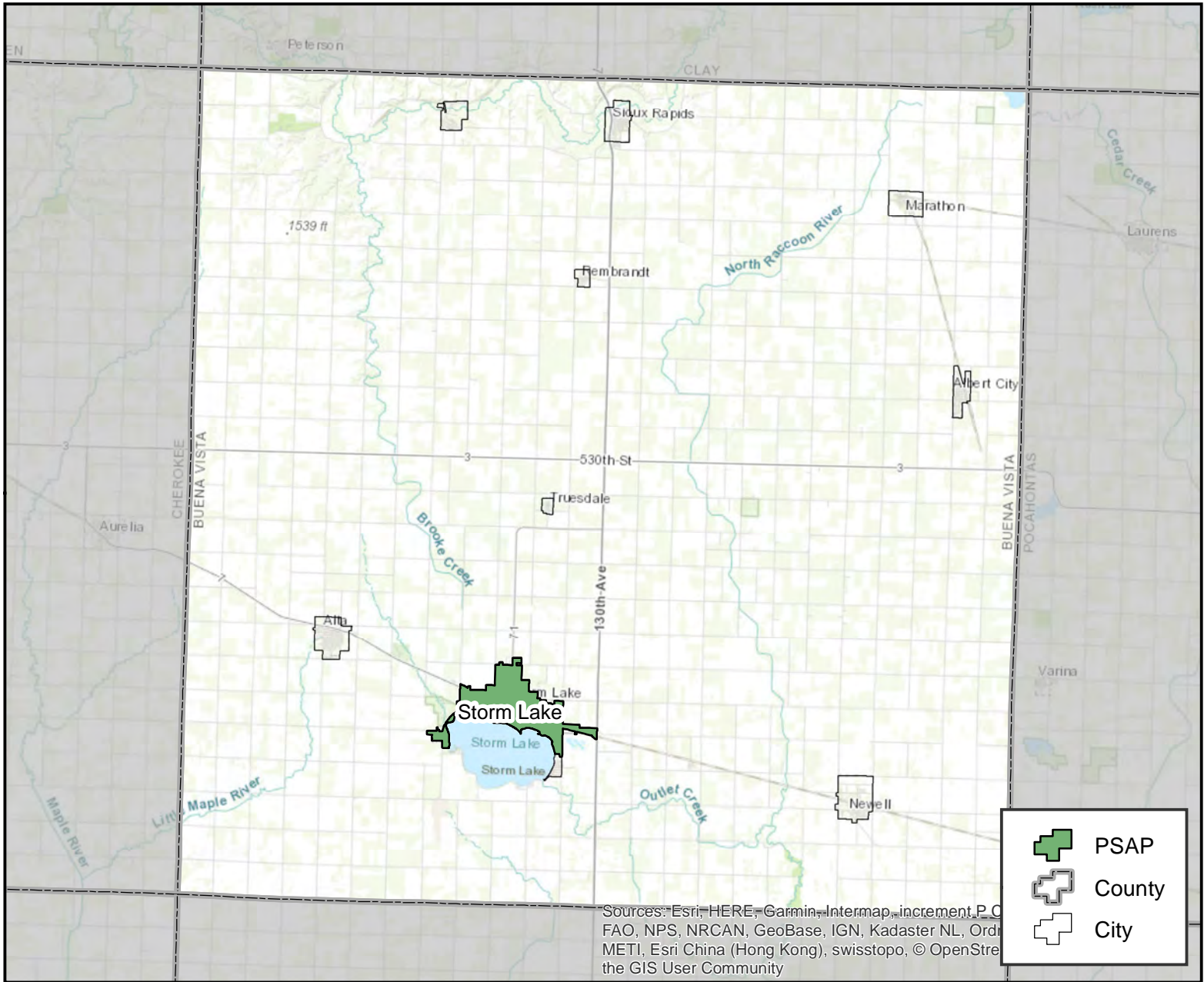

PSAP Information

Storm Lake Comm Center
FCC #: 1898
Phone #: 712-732-1341
1103 E Lakeshore Dr, Storm Lake, IA 50588

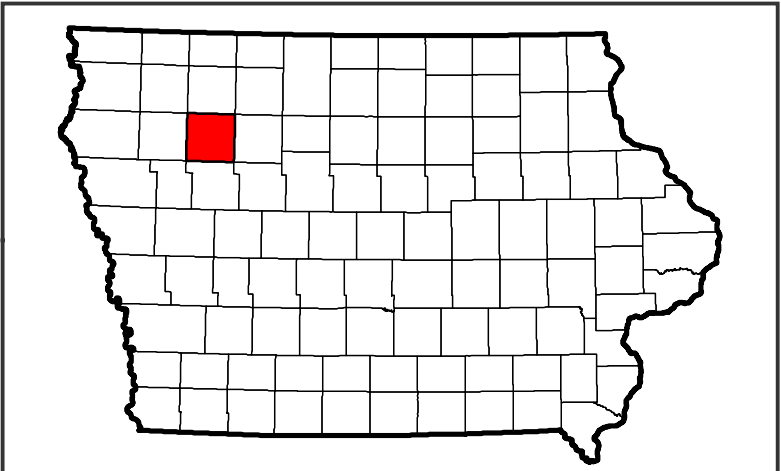

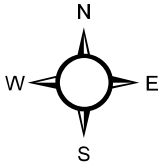

Butler County

Allison, Iowa

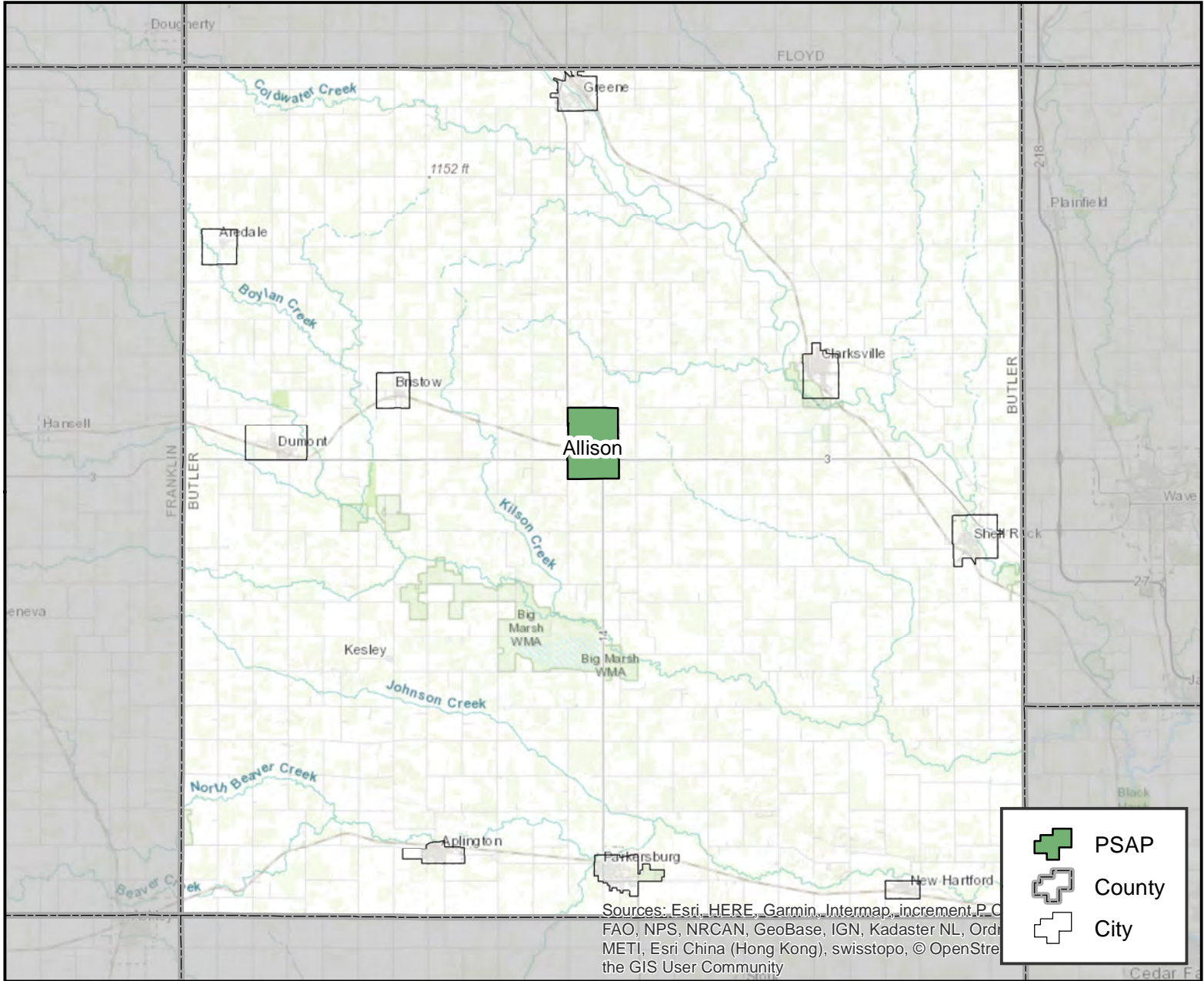

PSAP Information

Butler County Sheriffs Office
FCC #: 1908
Phone #: 319-267-2410
428 6th st Allison, IA 50602

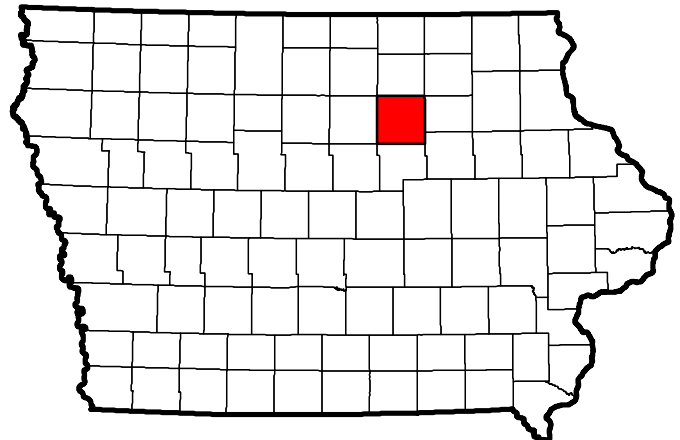

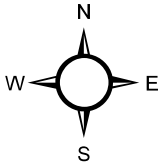

Calhoun County

Rockwell City, Iowa

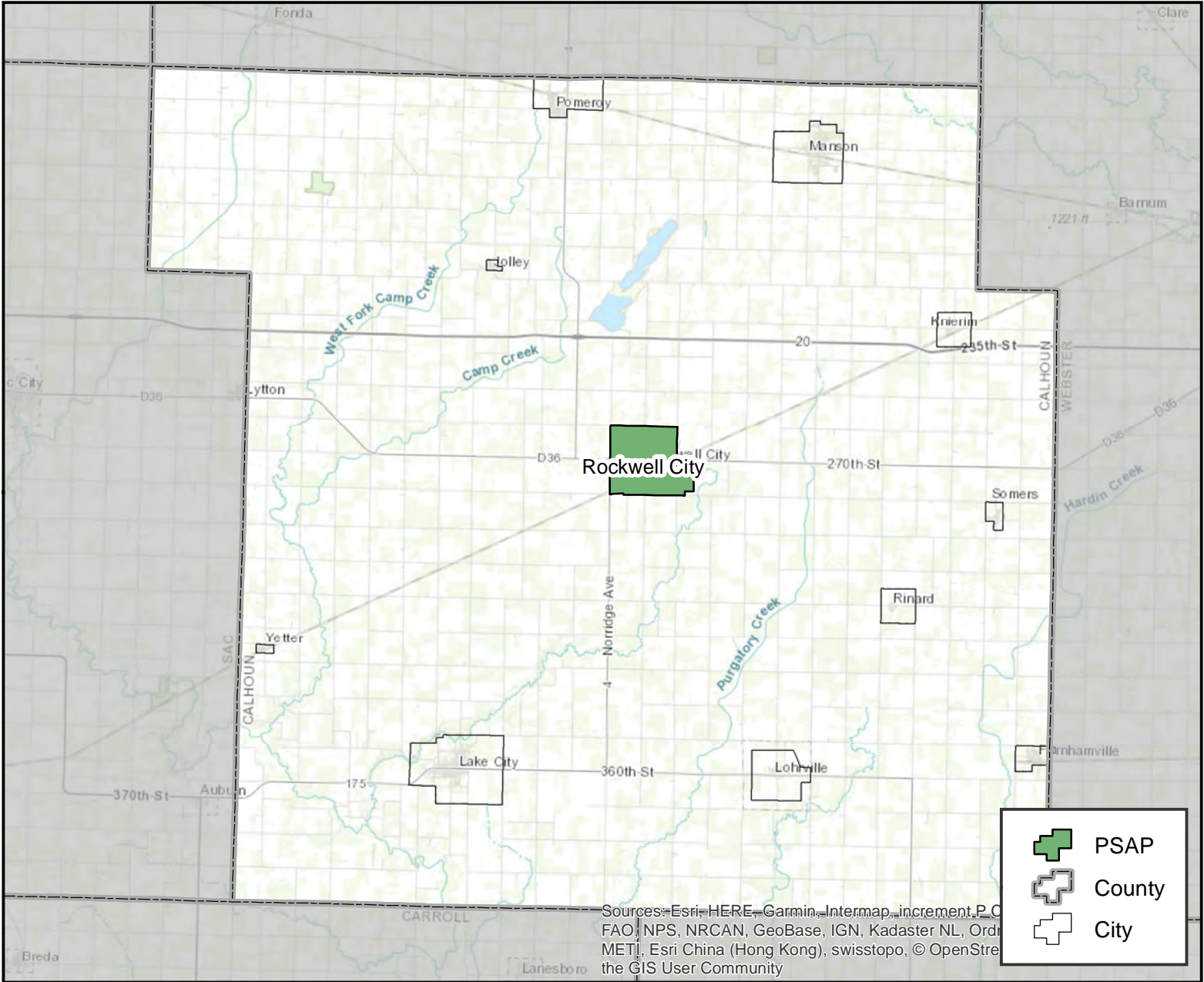

PSAP Information

Calhoun County Sheriffs Office
FCC #: 1909
Phone #: 712-297-7583
416 4th St. Rockwell City, IA 50579

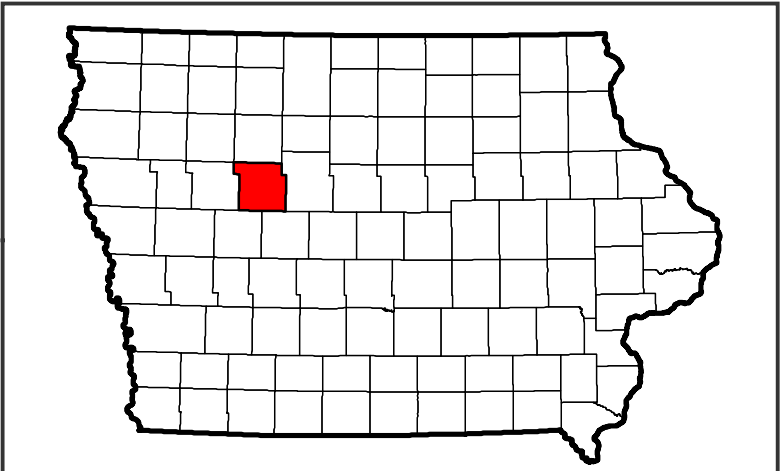

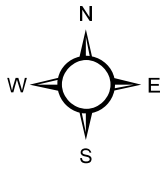

Carroll County

Carroll, Iowa

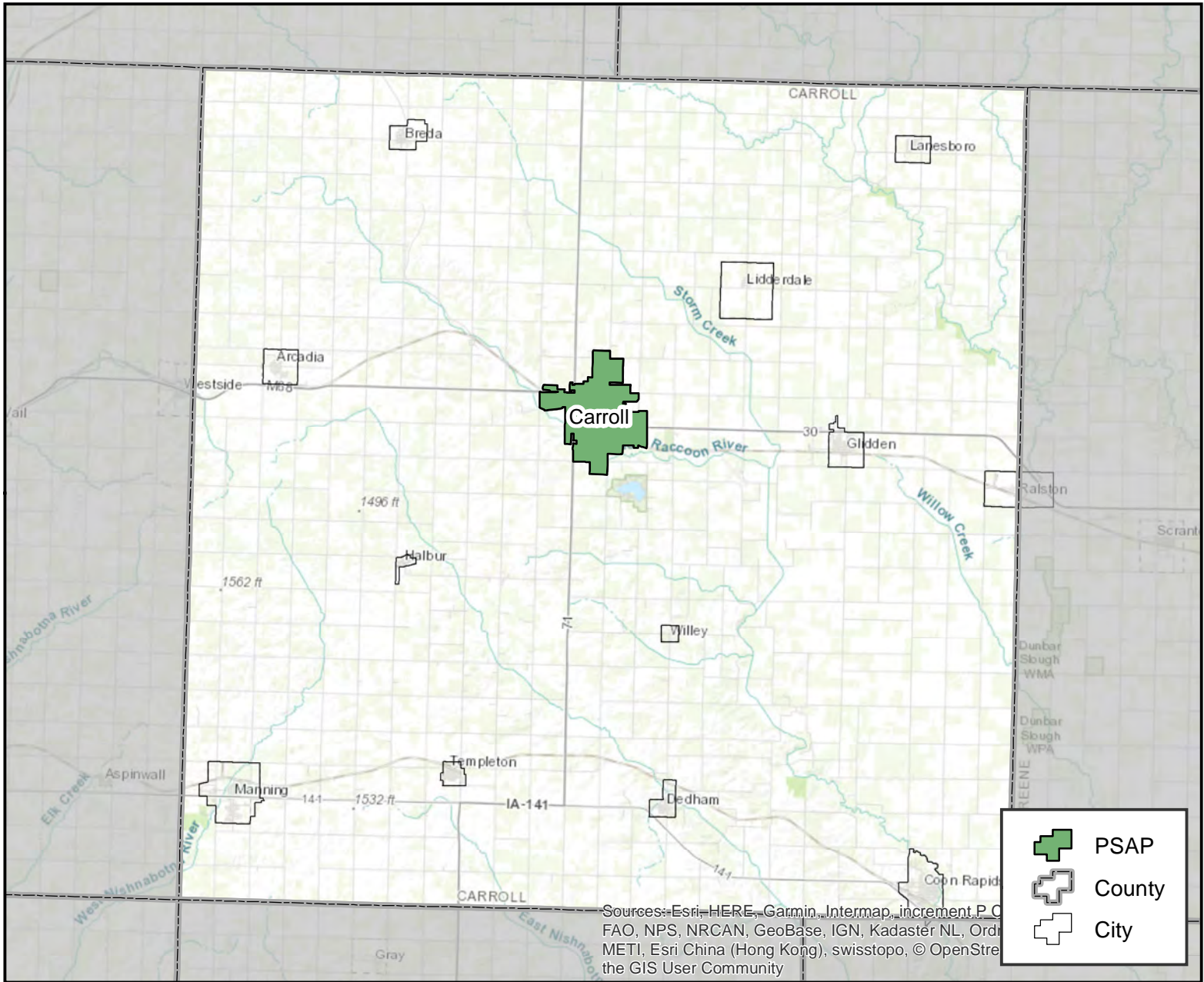

PSAP Information

Carroll County Communications
FCC #: 1910
Phone #: 712-792-3536
114 E. 6th St. Carroll, IA 51401

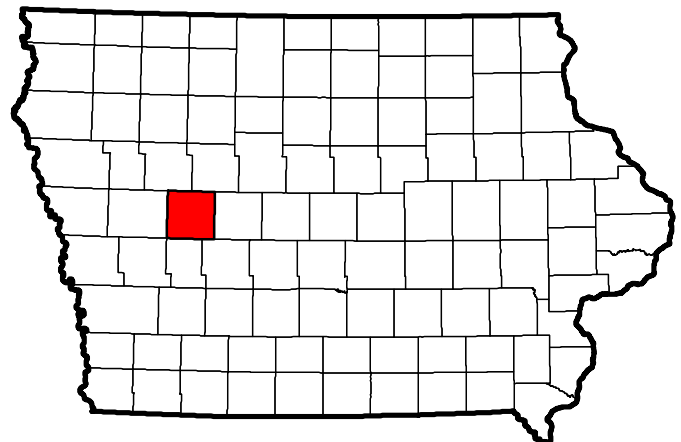

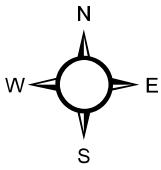

Cass County

Atlantic, Iowa

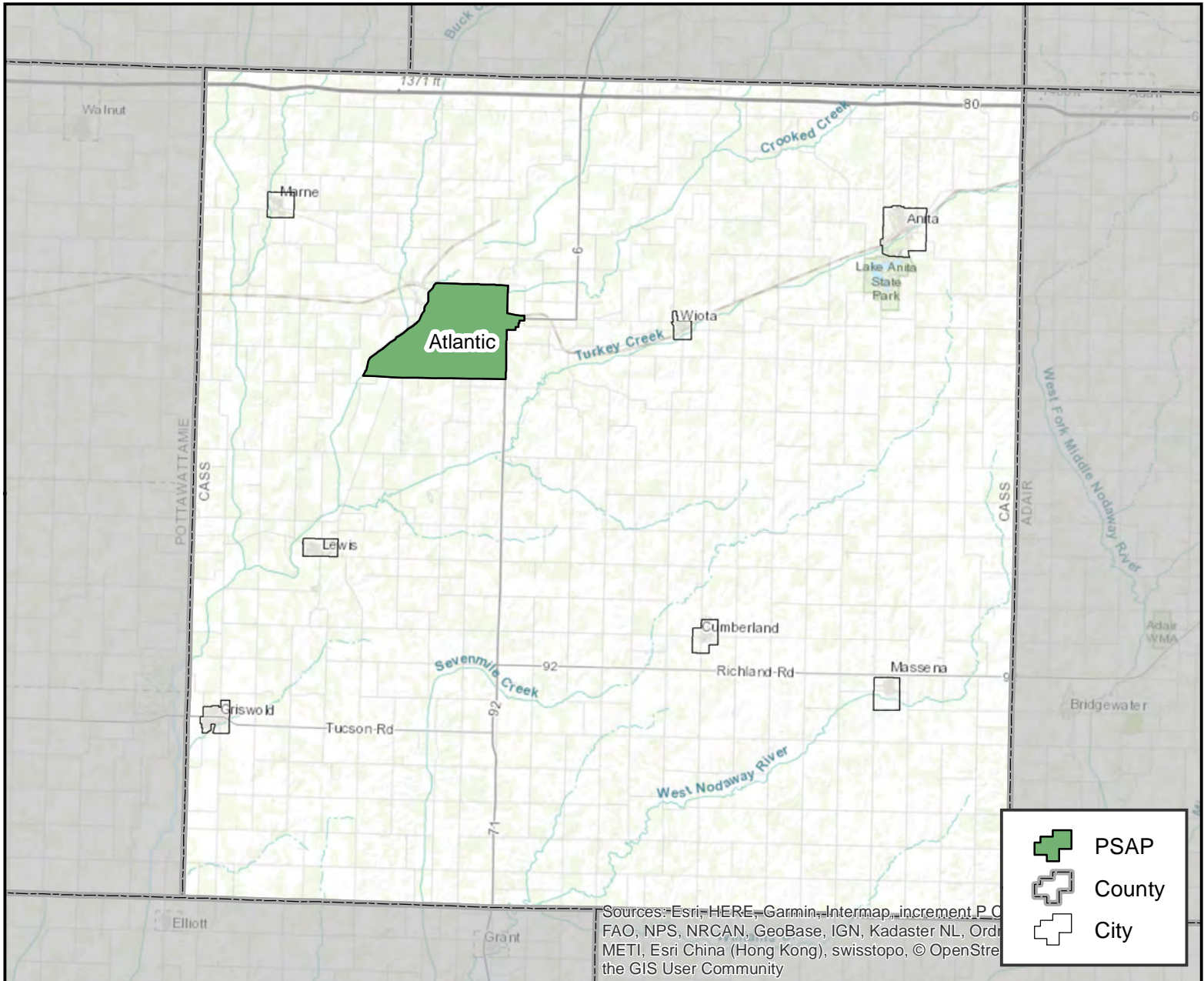

PSAP Information

Cass County Public Safety Communications Center
FCC #: 1911
Phone #: 712-243-2204
705 Poplar Street Atlantic, IA 50022

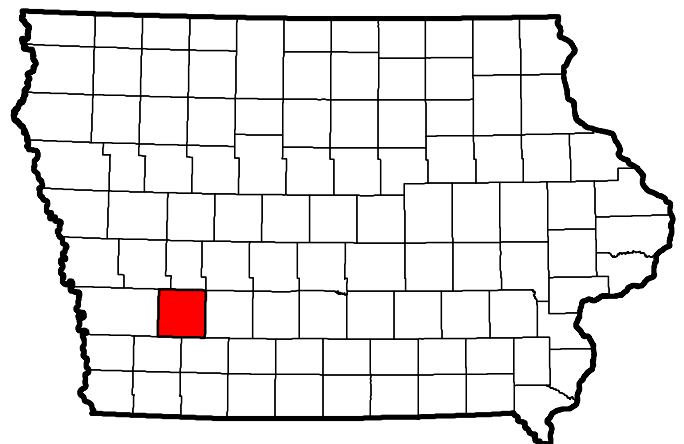

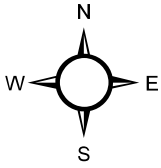

Cedar County

Tipton, Iowa

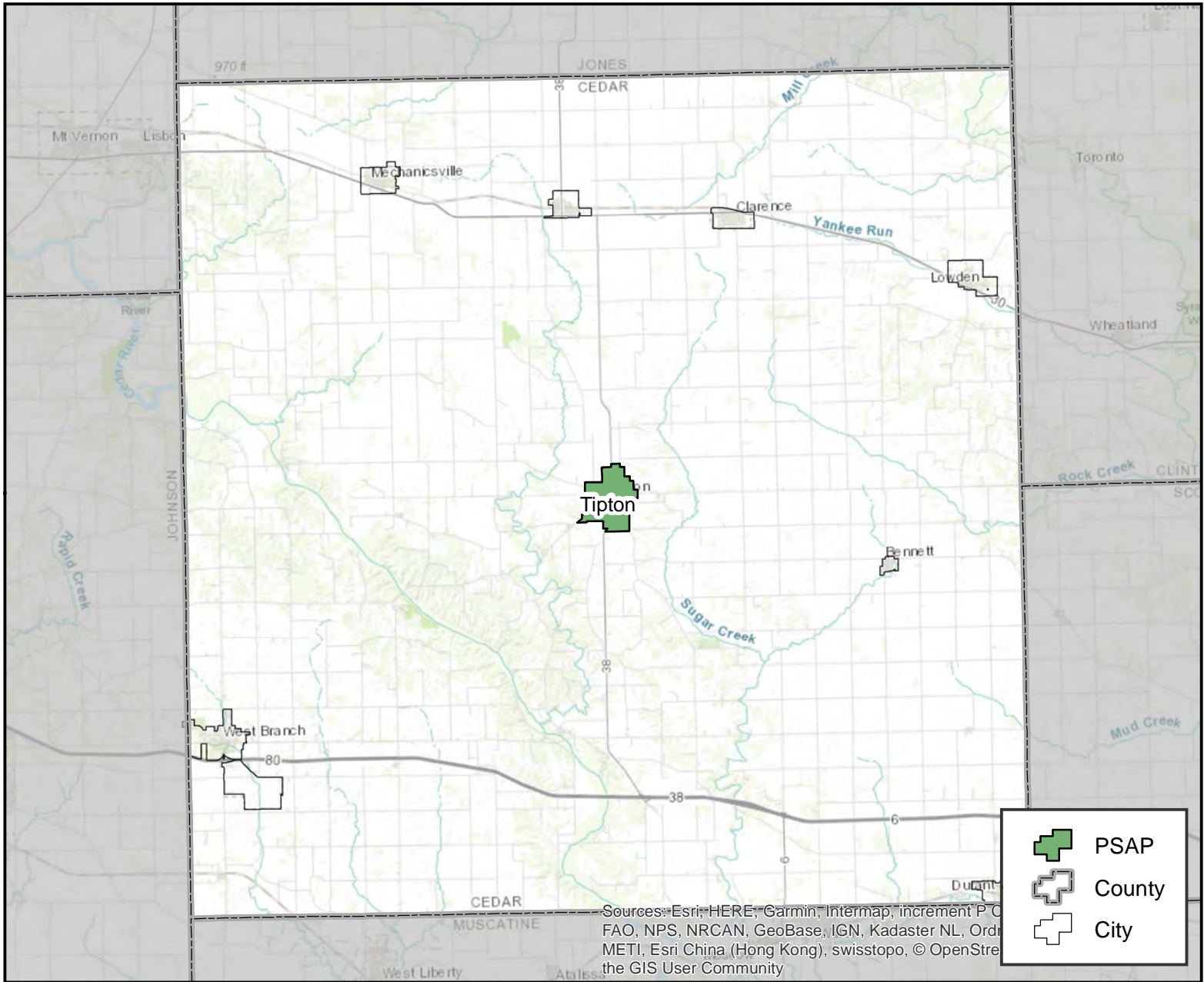

PSAP Information

Cedar County Sheriff's Office
FCC #: 1912
Phone #: 563-886-2121
711 E. South Street Tipton, IA 52772

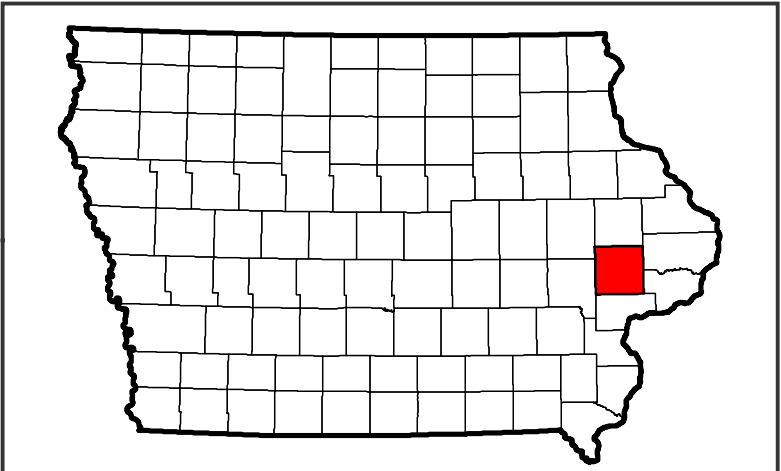

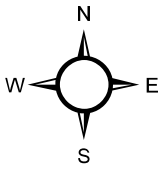

Cerro Gordo County

Clear Lake, Iowa

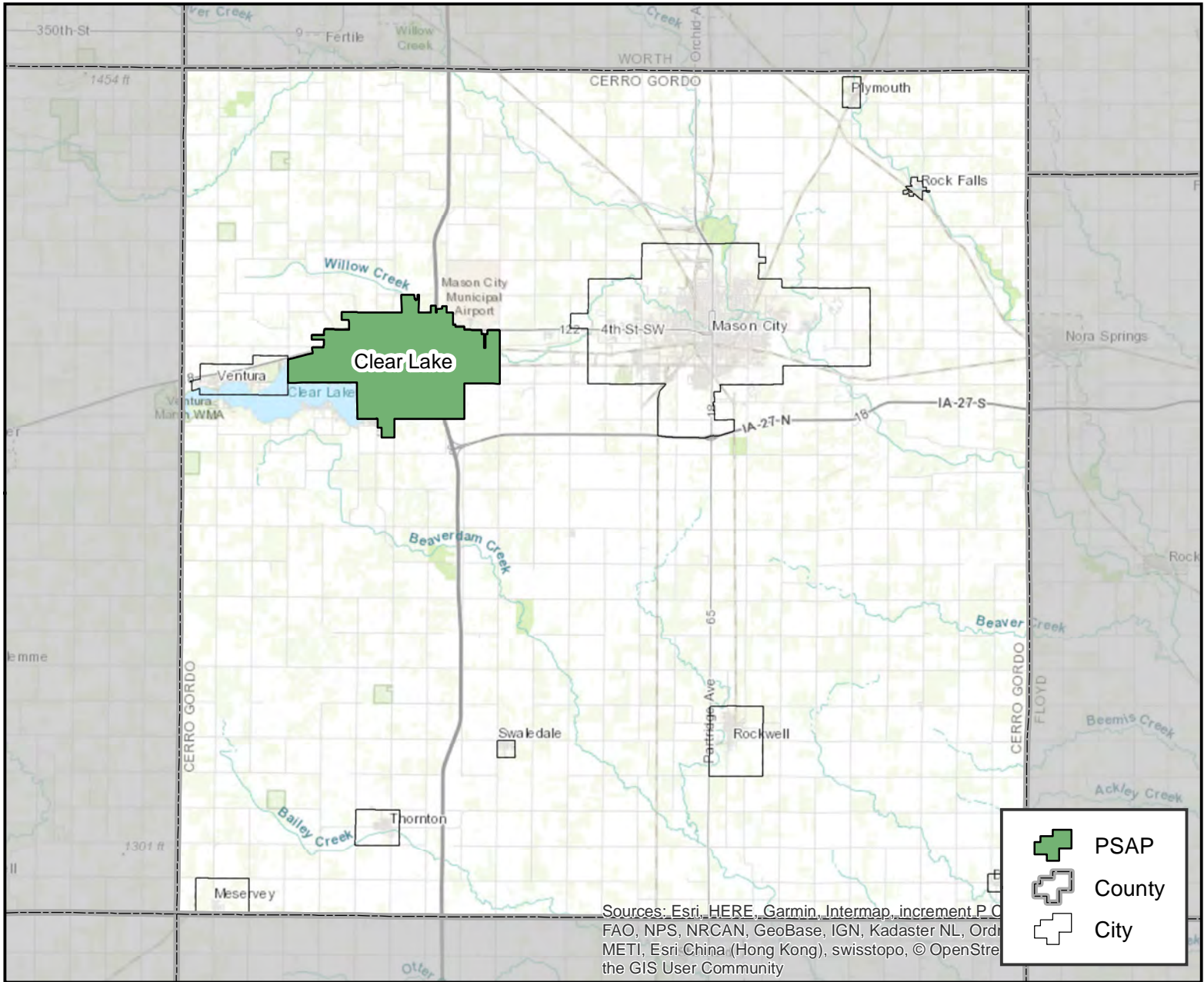

PSAP Information

Clear Lake Police Department
FCC #: 1925
Phone #: 641-357-2186
511 1st Avenue North Clear Lake, IA 50428

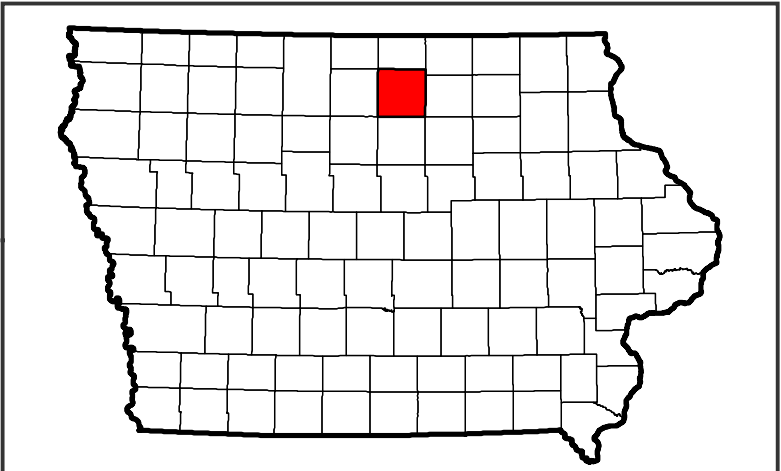

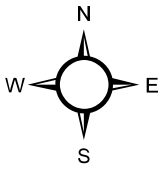

Cerro Gordo County

Mason City, Iowa

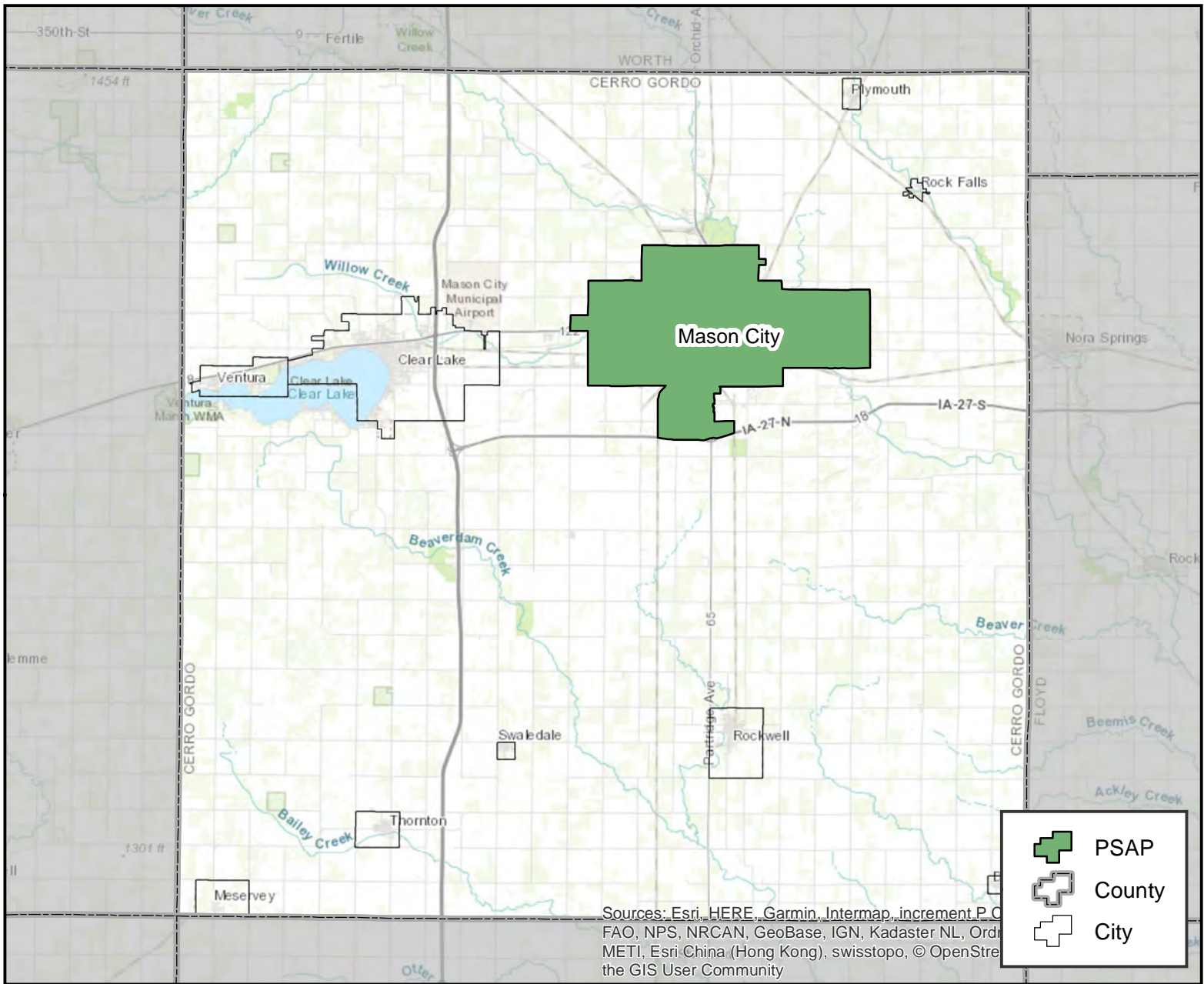

PSAP Information

Cerro Gordo County Sheriff
FCC #: 1916
Phone #: 641-421-3000
17262 Lark Avenue Mason City, IA 50401

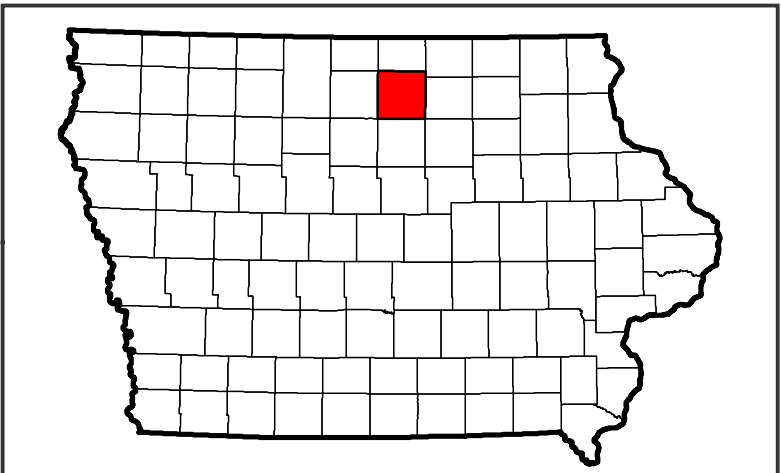

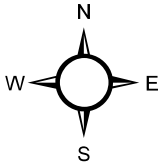

Cherokee County

Cherokee, Iowa

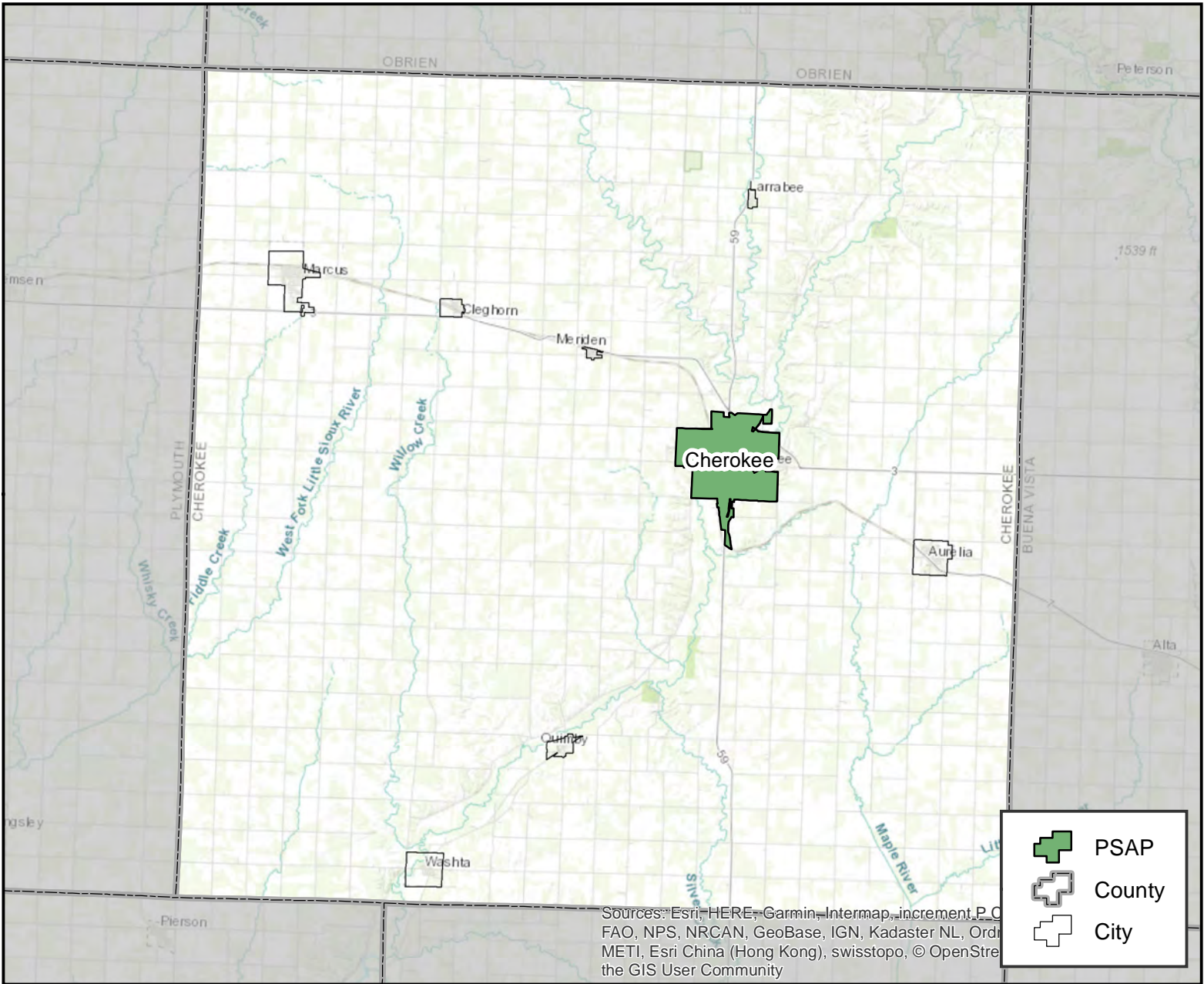

PSAP Information

Cherokee County Sheriff
FCC #: 1917
Phone #: 712-225-6728
111 N 5th Street Cherokee, IA 51012

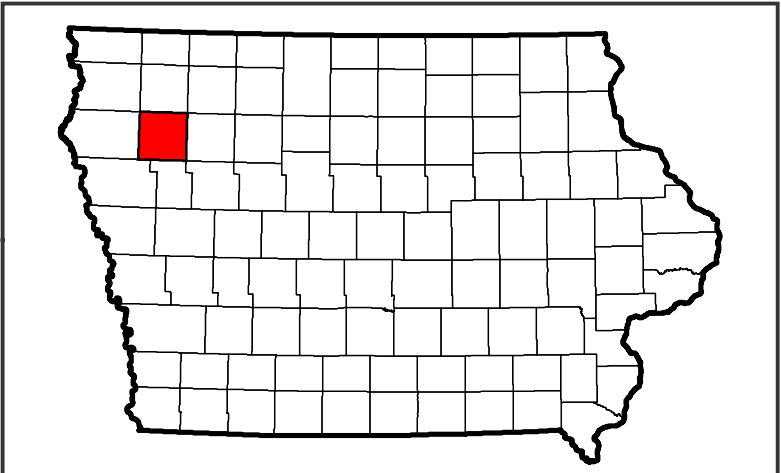

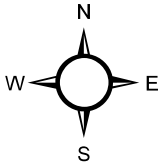

Chickasaw County

New Hampton, Iowa

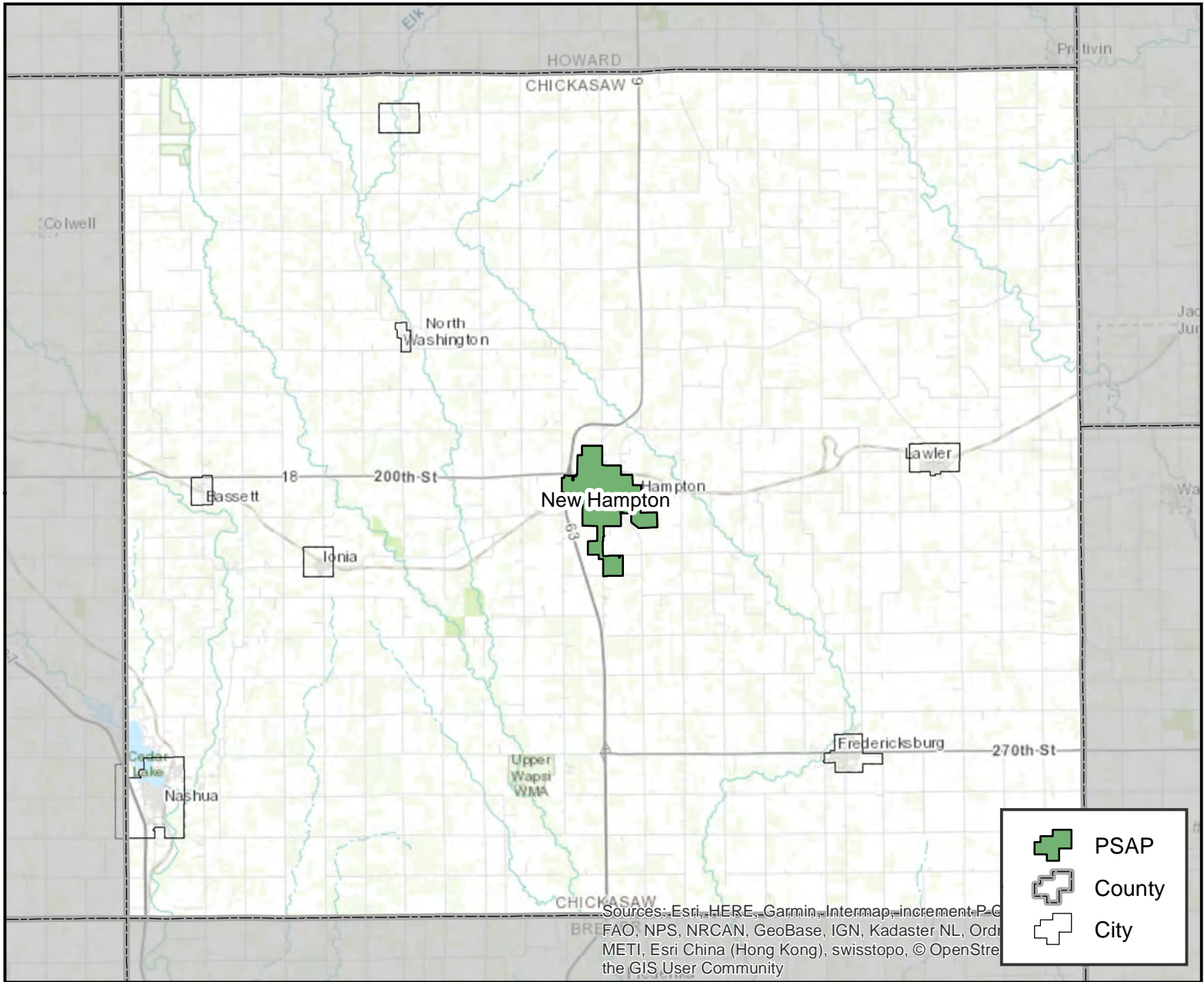

PSAP Information

Chickasaw County
FCC #: 1919
Phone #: 641-229-6101
116 N Chestnut AVE New Hampton, IA 50659

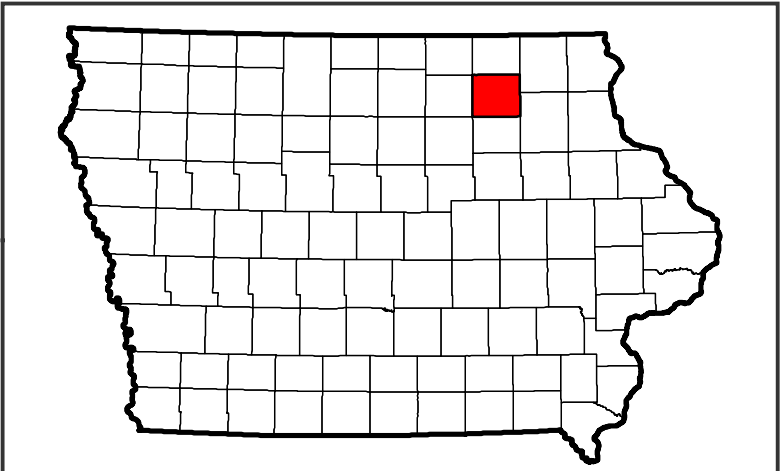

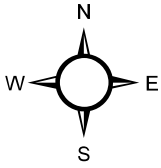

Clarke County

Osceola, Iowa

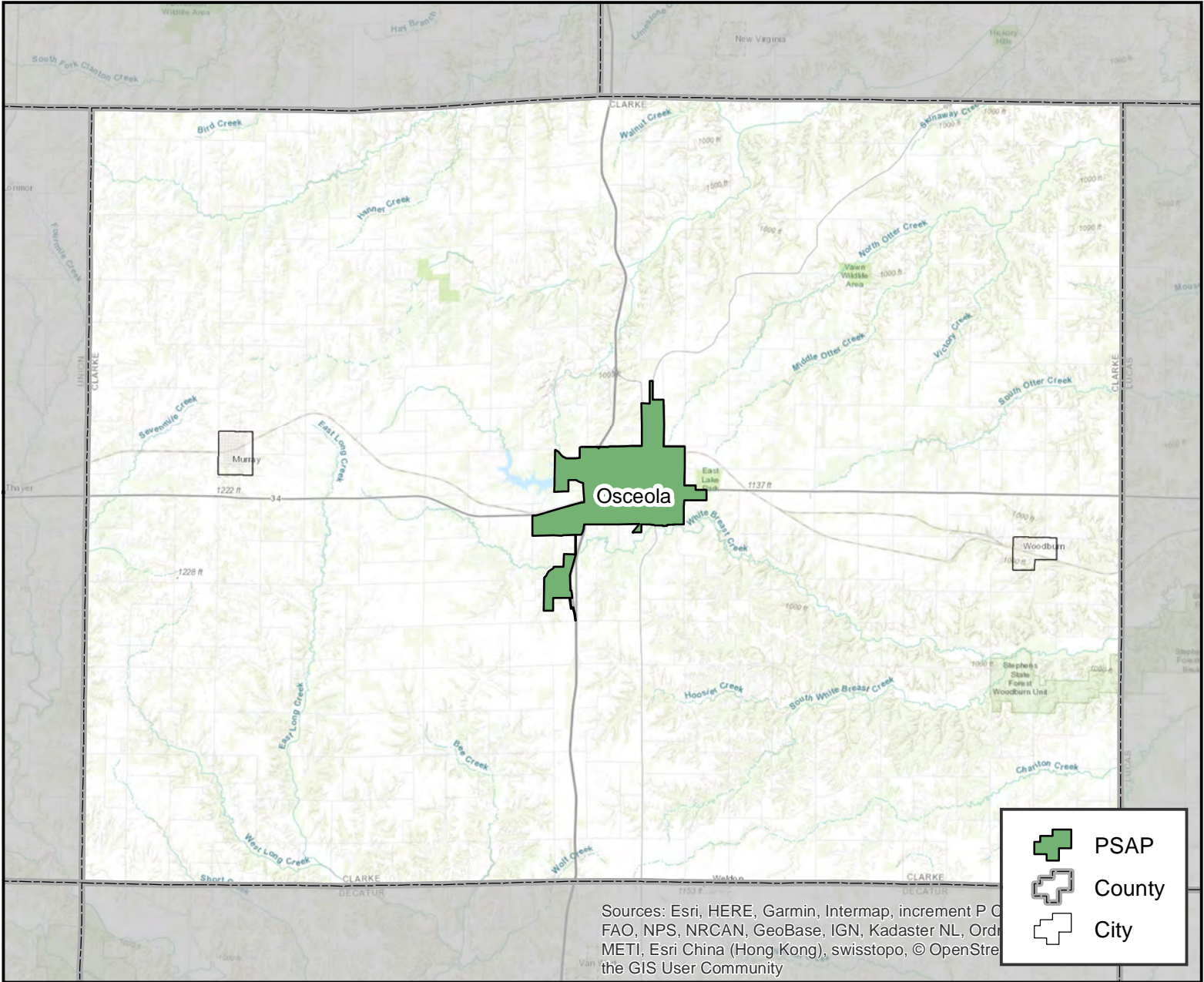

PSAP Information

Clarke County Sheriff's Office
FCC #: 1921
Phone #: 641-342-2914
220 Townline Rd Osceola, IA 50213

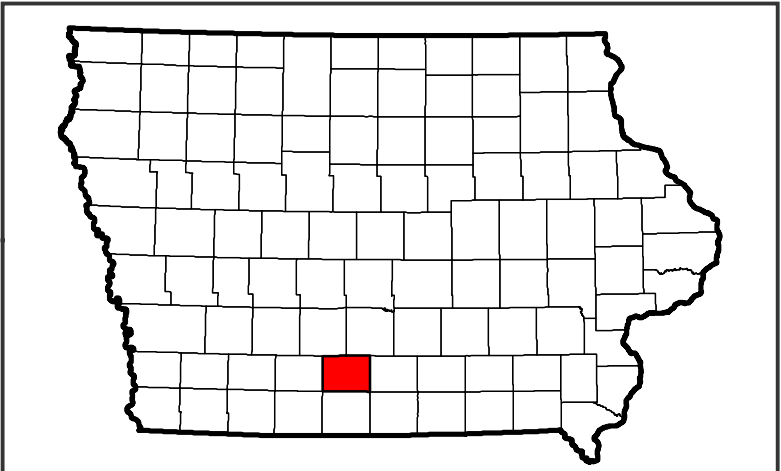

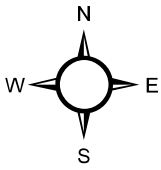

Clay County

Spencer, Iowa

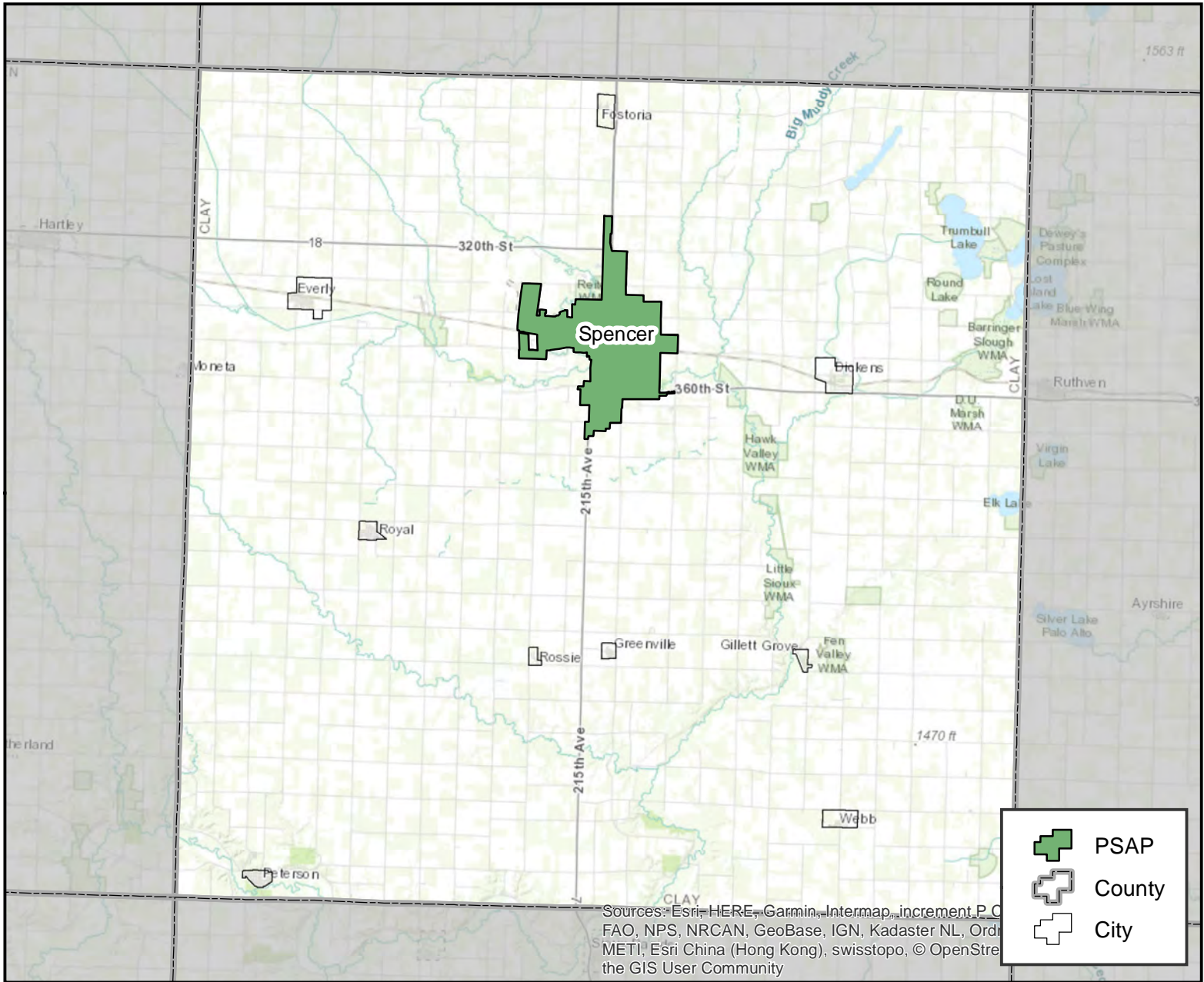

PSAP Information

Clay County PSAP
FCC #: 1922
Phone #: 712-262-2151
712 Grand Ave Spencer, IA 51301

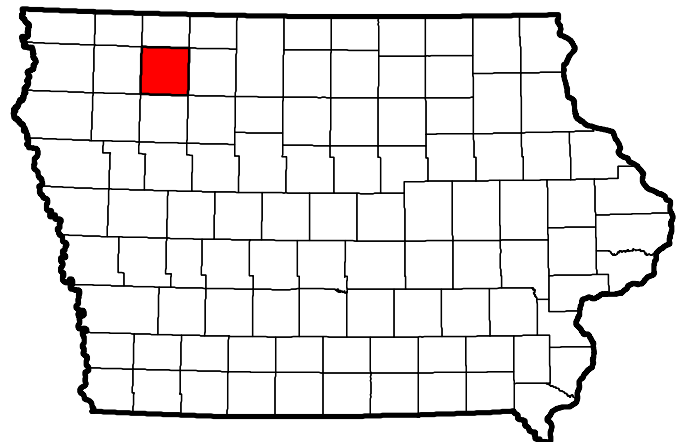

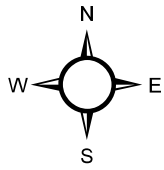

Clayton County

St. Olaf, Iowa

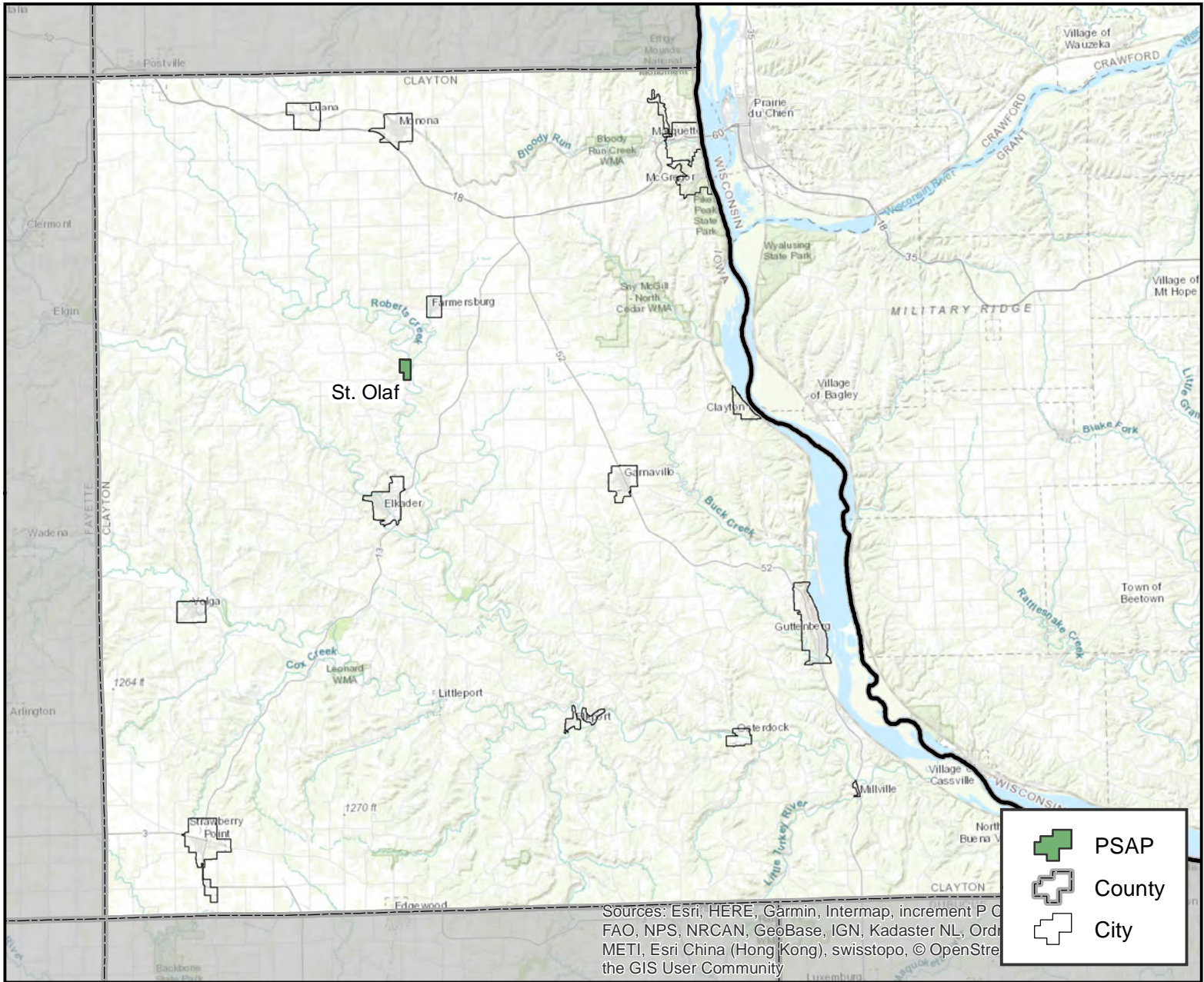

PSAP Information

Clayton County Sheriffs Office
FCC #: 1924
Phone #: 563-245-2422
22680 230th Street Saint Olaf, IA 52072

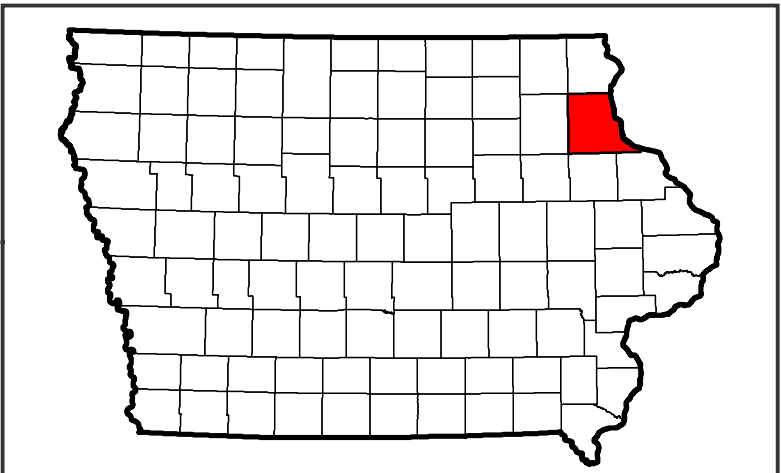

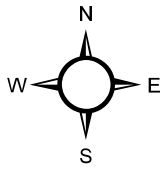

Clinton County

Clinton, Iowa

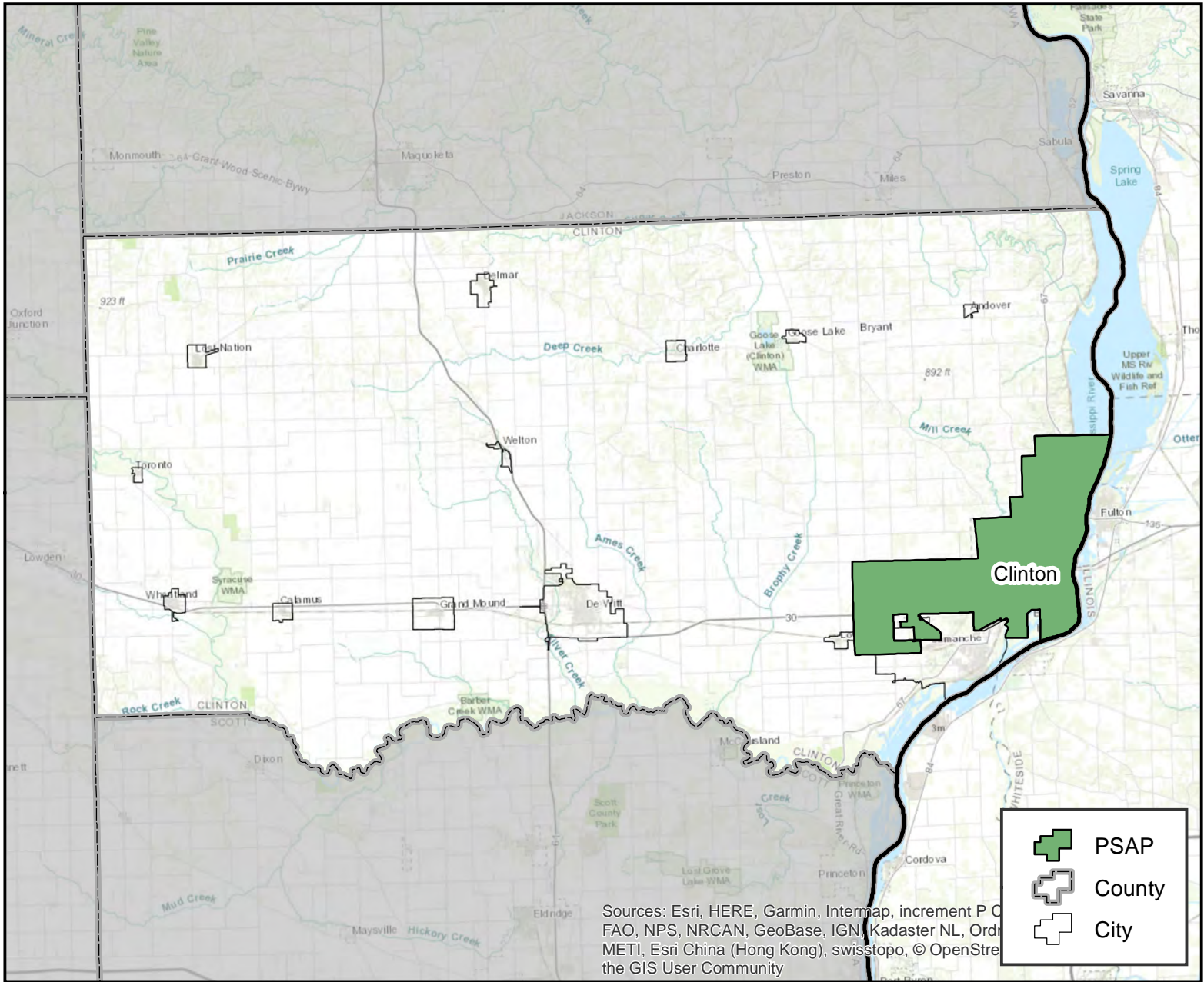

PSAP Information

Clinton County Communications
FCC #: 1926
Phone #: 563-243-1458
241 7th Ave. North Clinton, IA 52732

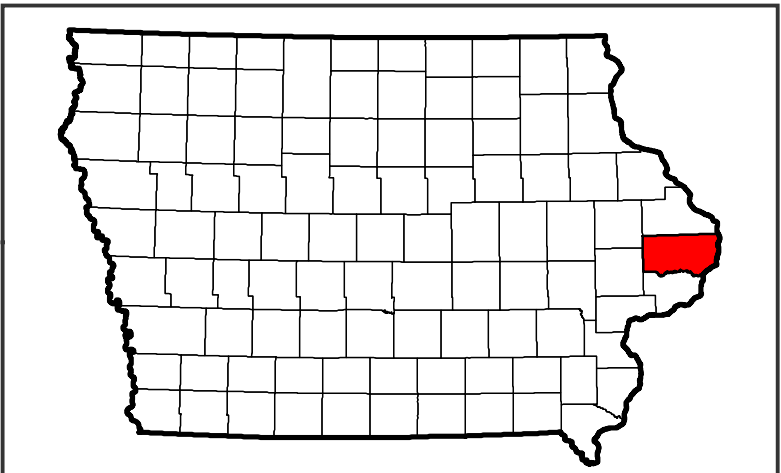

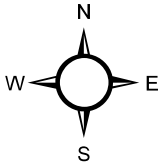

Crawford County

Denison, Iowa

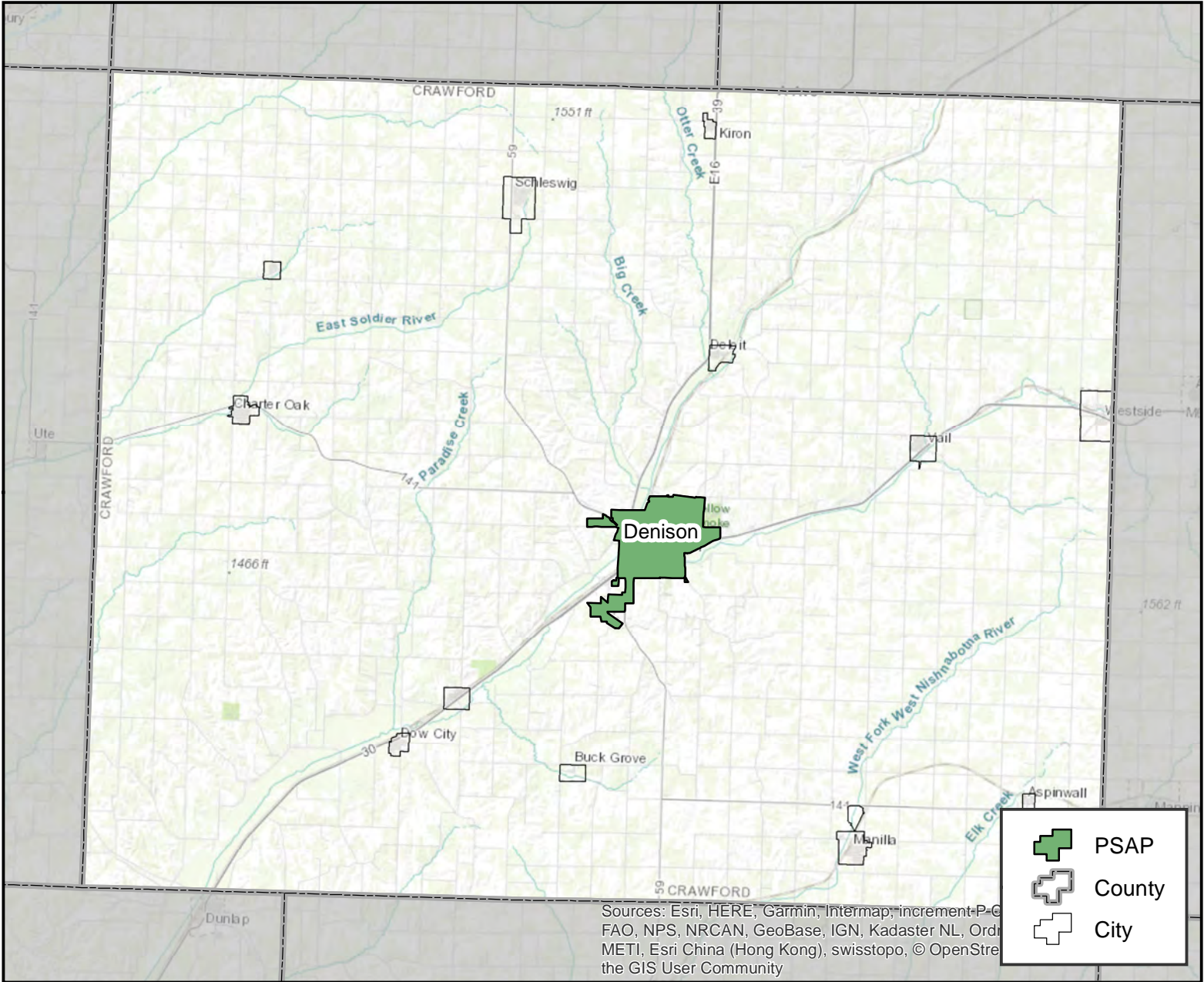

PSAP Information

Crawford County Communications Center
FCC #: 1928
Phone #: 712-263-3195
1119 1st Ave North Denison, IA 51442

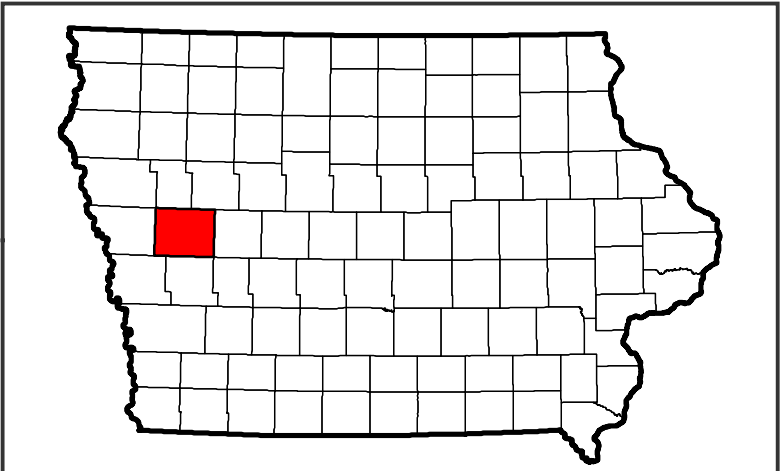

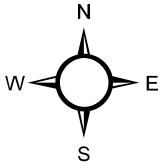

Dallas County

Adel, Iowa

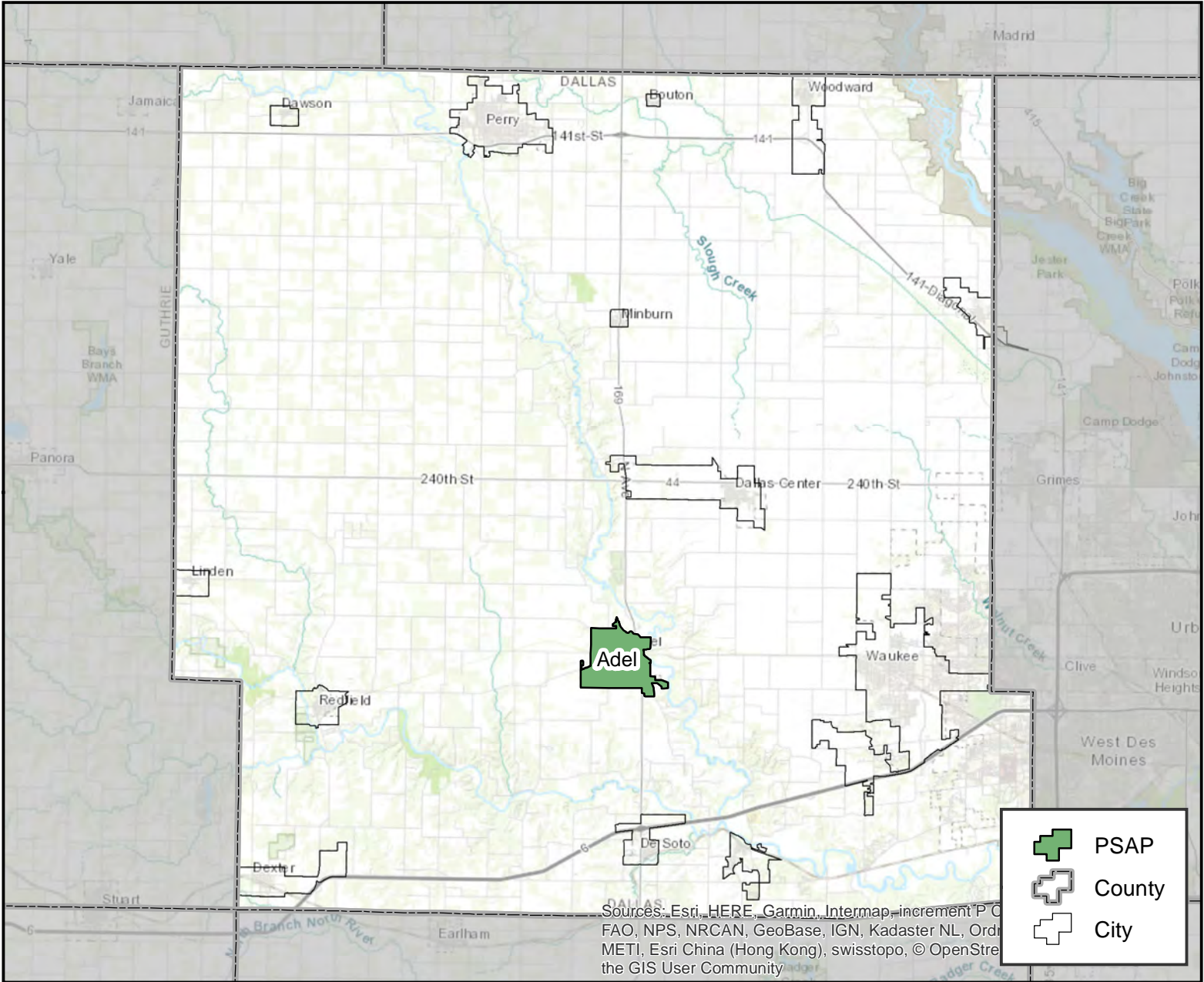

PSAP Information

Dallas County Sheriff Communications
FCC #: 1930
Phone #: 515-993-4567
25747 N Ave Ste E Adel, IA 50003

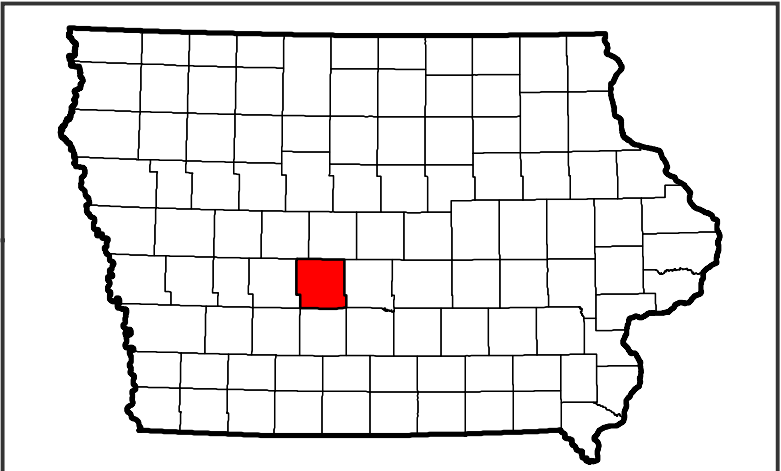

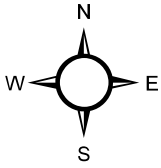

Dallas County

Perry, Iowa

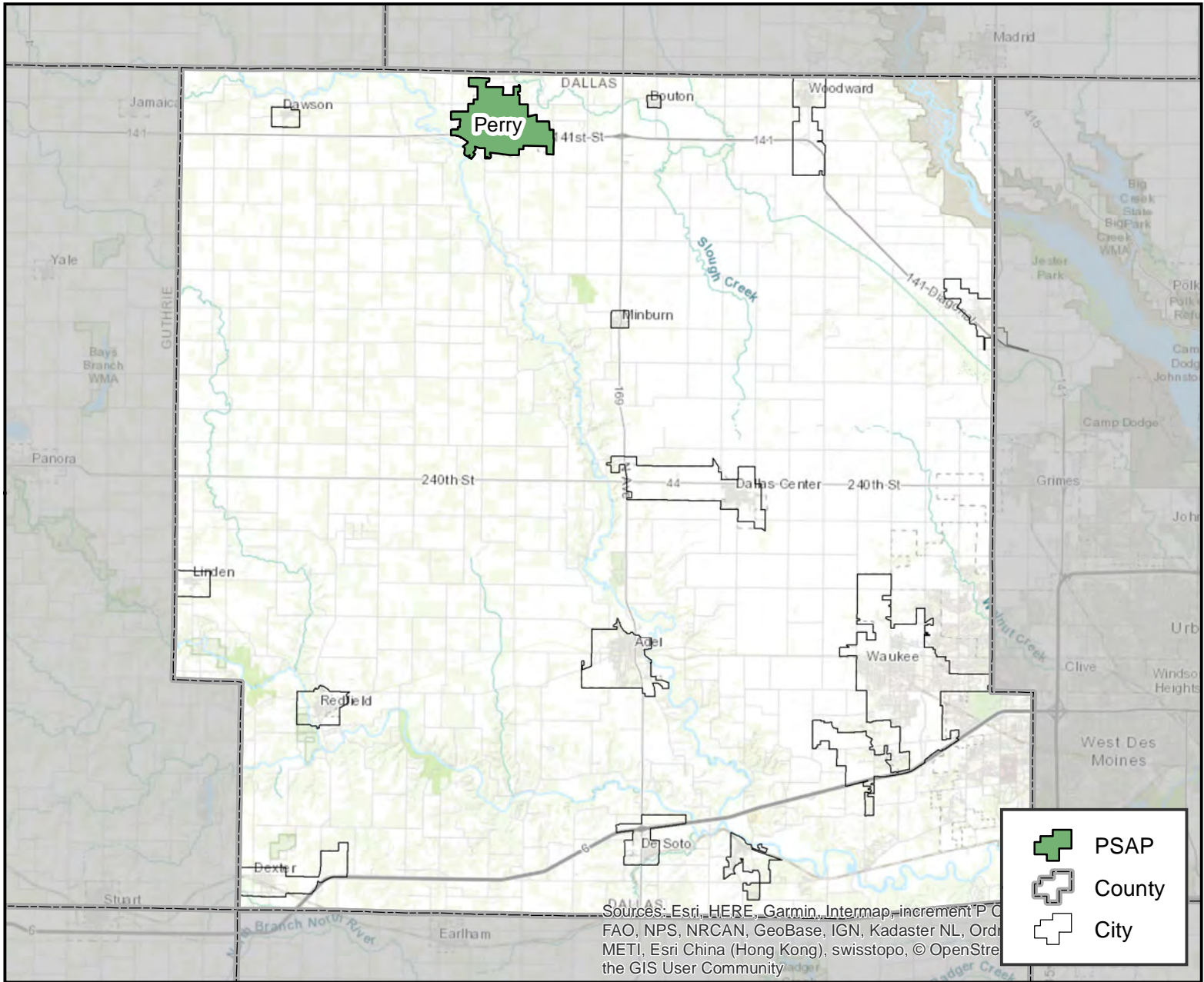

PSAP Information

Perry Police Department FCC #:
2001
Phone #: 515-465-4636
908 Willis Ave Perry, IA 50220

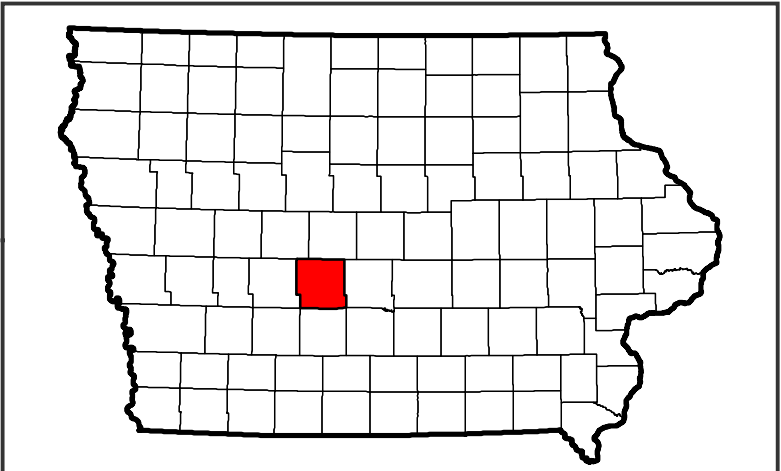

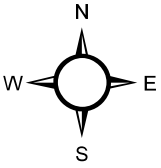

Davis County

Bloomfield, Iowa

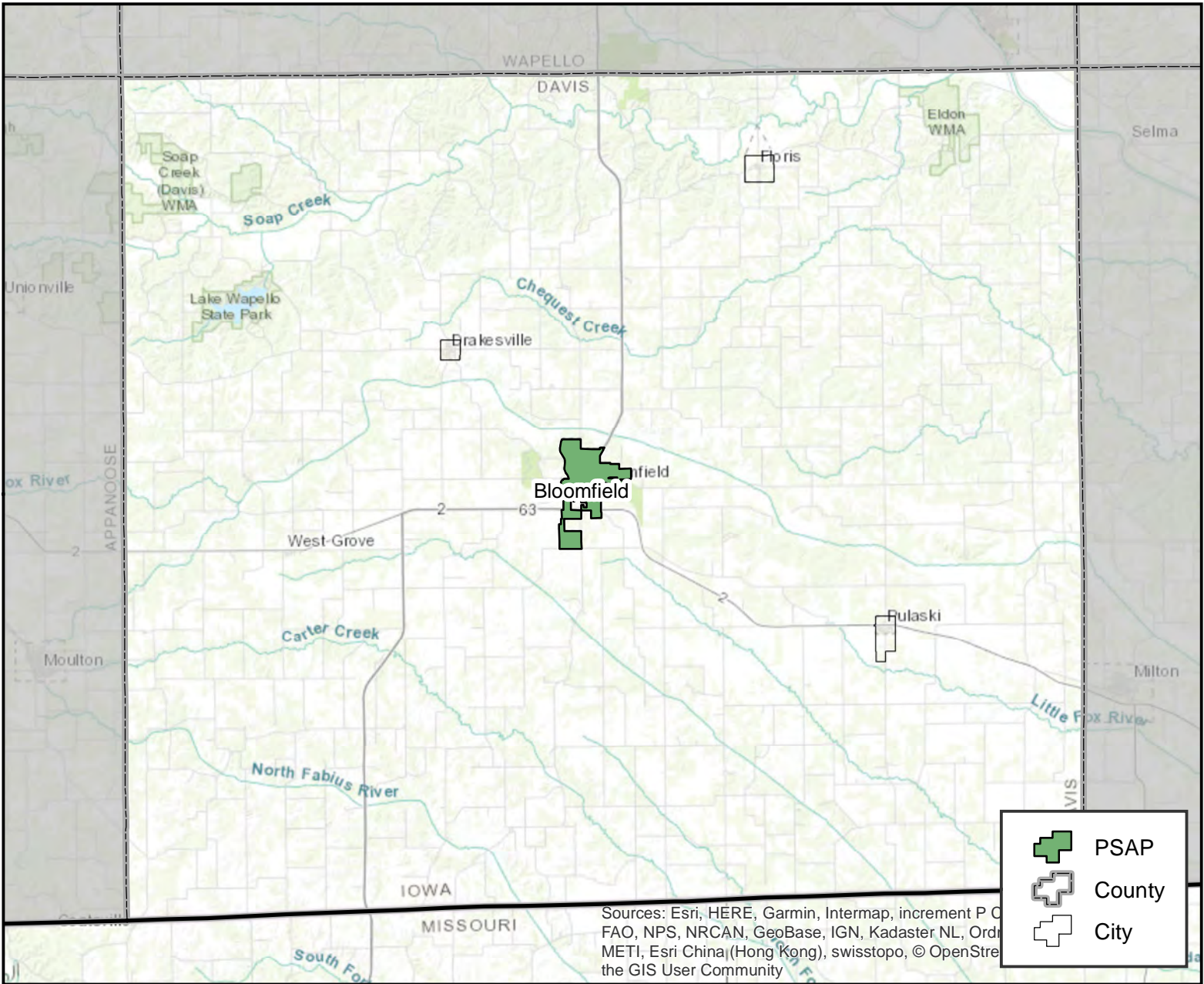

- PSAP
- County
- City

Sources: Esri, HERE, Garmin, Intermap, increment P Corp., FAO, NPS, NRCAN, GeoBase, IGN, Kadaster NL, Ordnance Survey, Esri China (Hong Kong), swisstopo, © OpenStreetMap contributors, and the GIS User Community

PSAP Information

Davis County Law Center
FCC #: 1932
Phone #: 641-664-2700
102 Anderson St Bloomfield, IA 52537

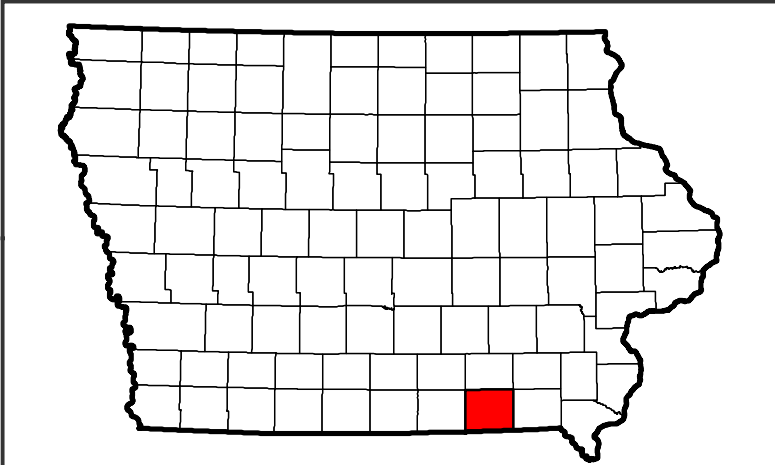

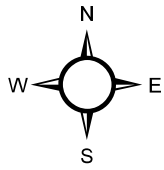

Decatur County

Leon, Iowa

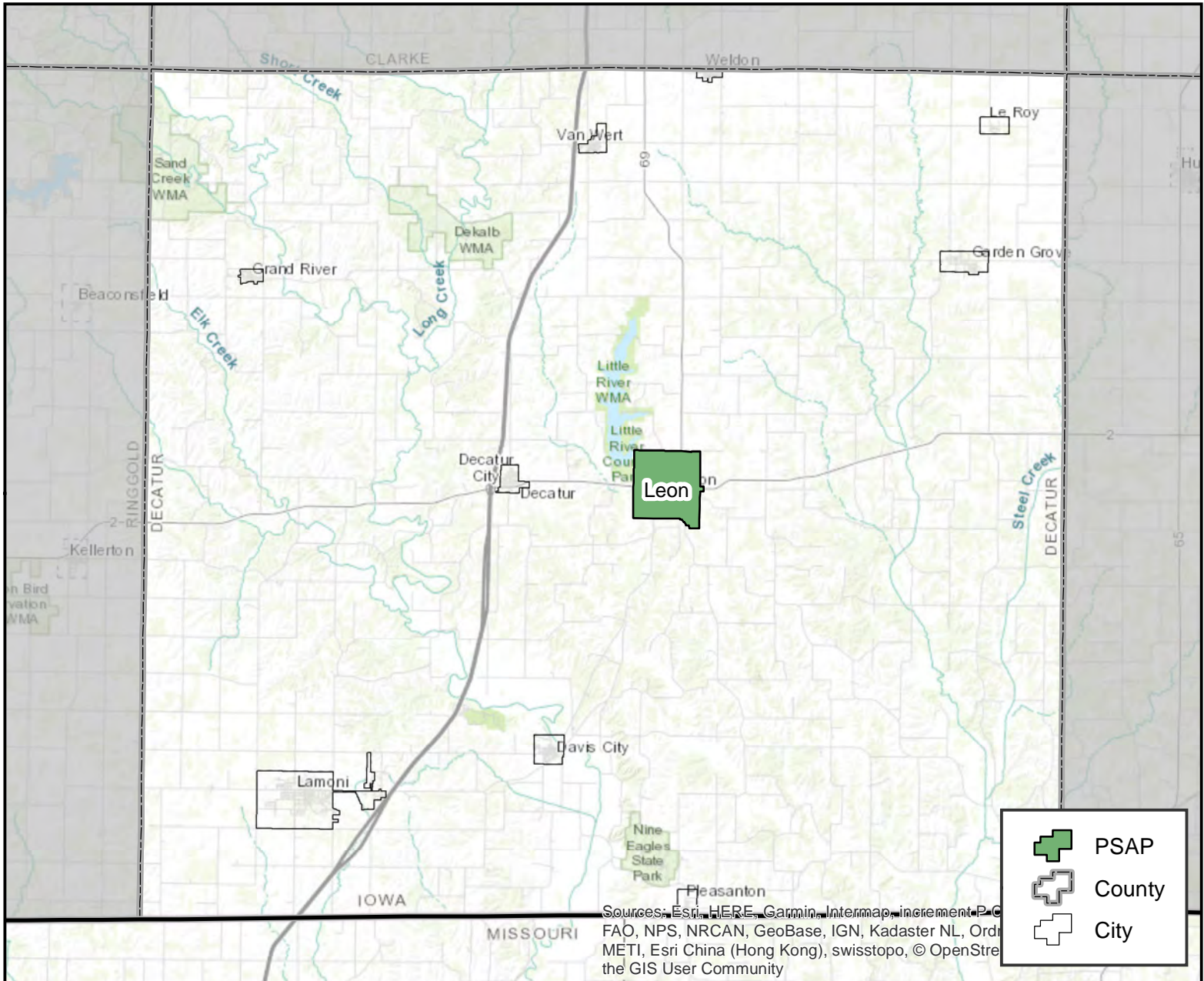

PSAP Information

Decatur County Sheriff's Office
FCC #: 1933
Phone #: 641-446-4111
206 NE 2nd St Leon, IA 50144

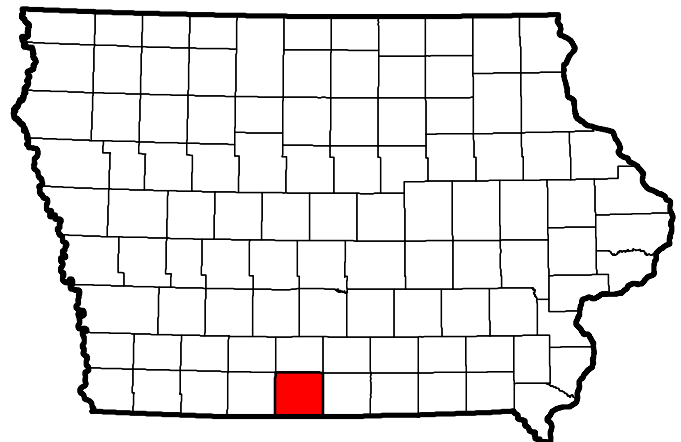

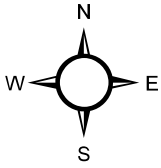

Delaware County

Manchester, Iowa

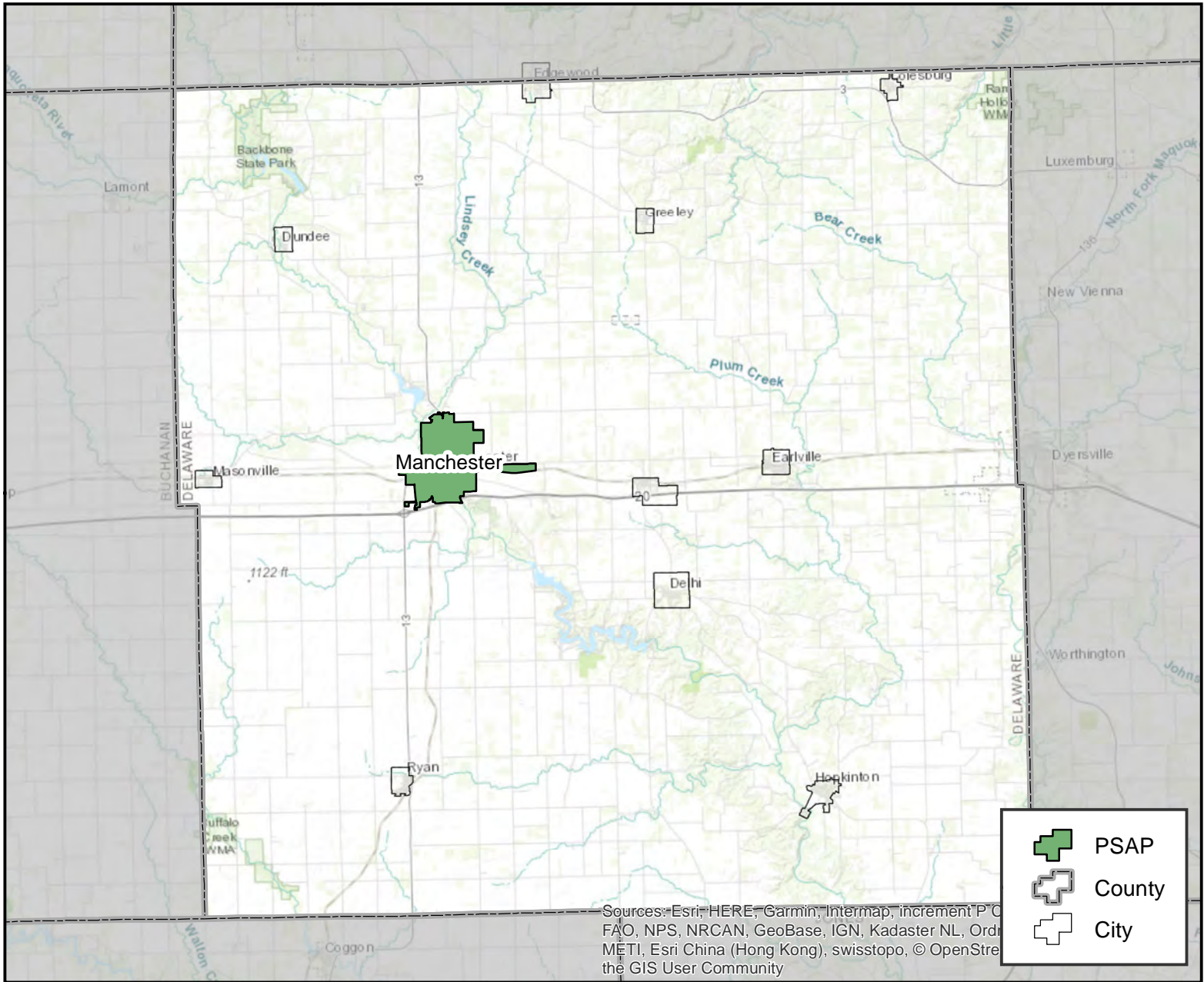

PSAP Information

Delaware County Communication Center
FCC #: 1981
Phone #: 563-927-3355
208 East Main Street Manchester, IA 52057

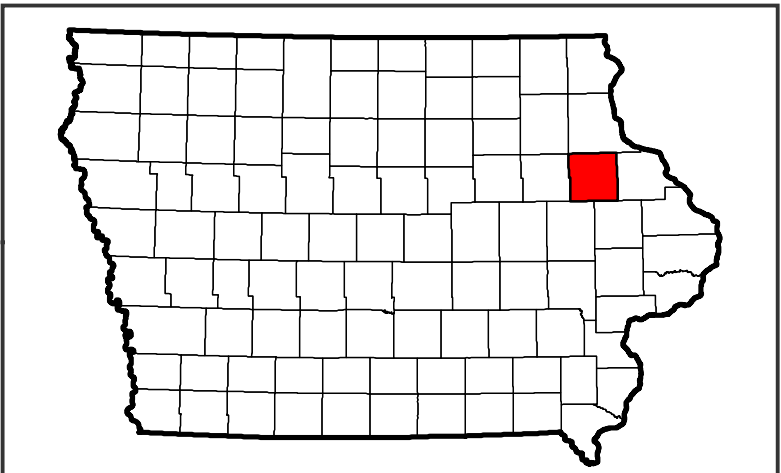

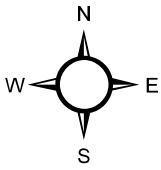

Des Moines County

West Burlington, Iowa

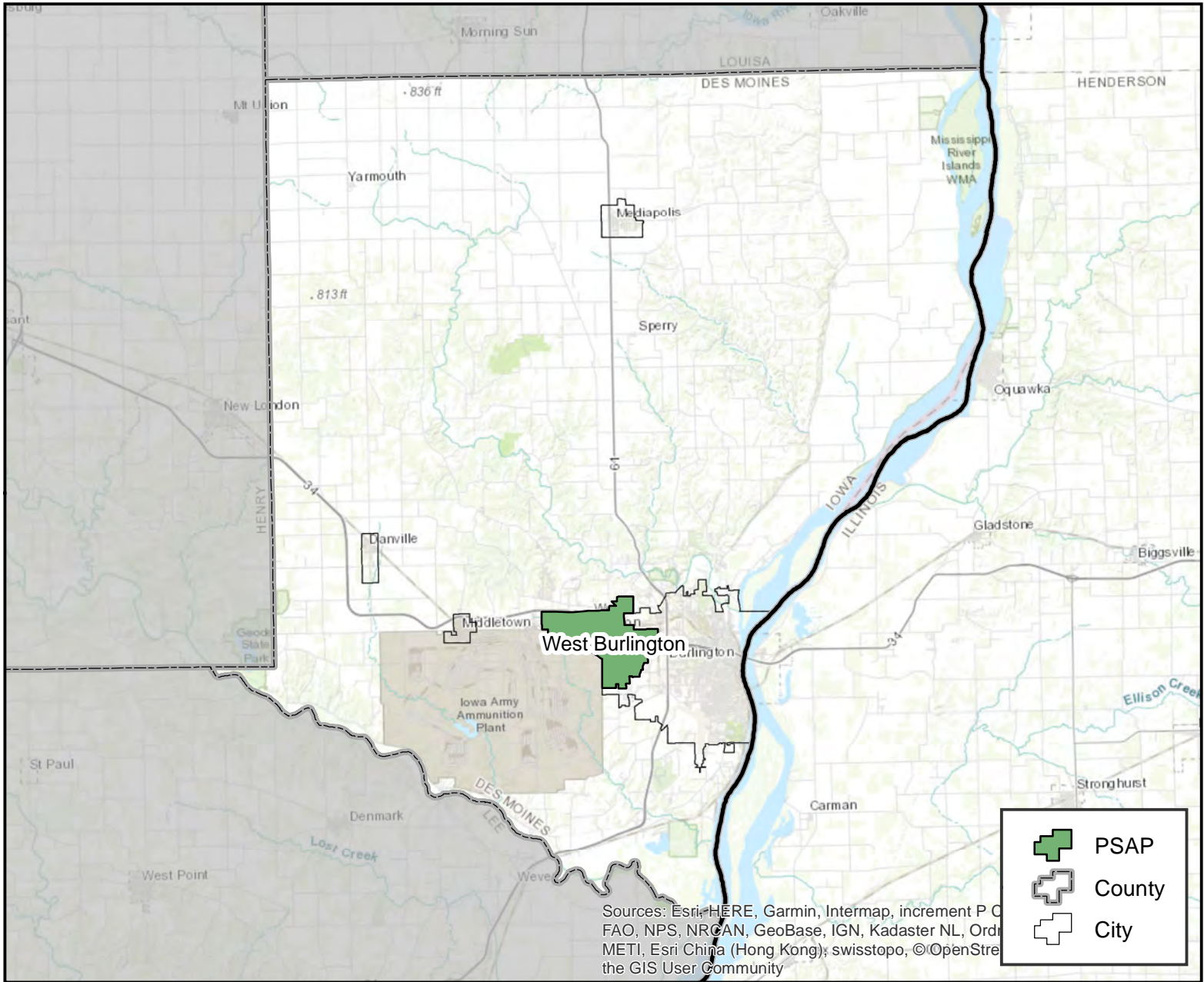

PSAP Information

DESCOM - Des Moines County
FCC #: 1907
Phone #: 319-671-7001
1401 W Agency Rd, West Burlington, IA 52655

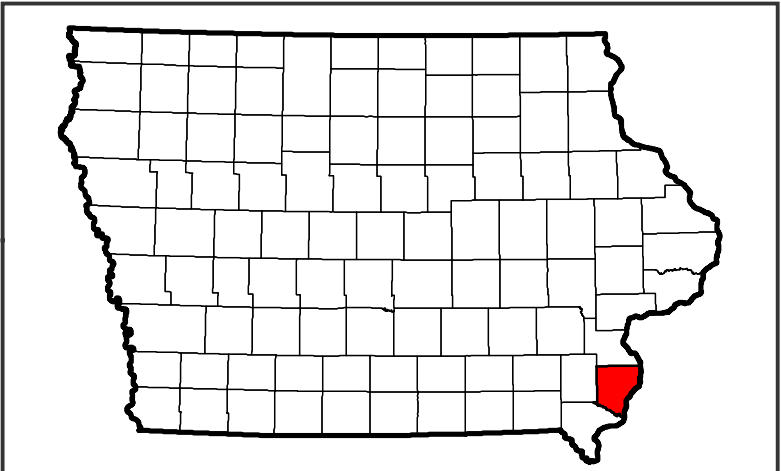

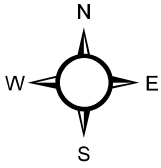

Dickinson County

Spirit Lake, Iowa

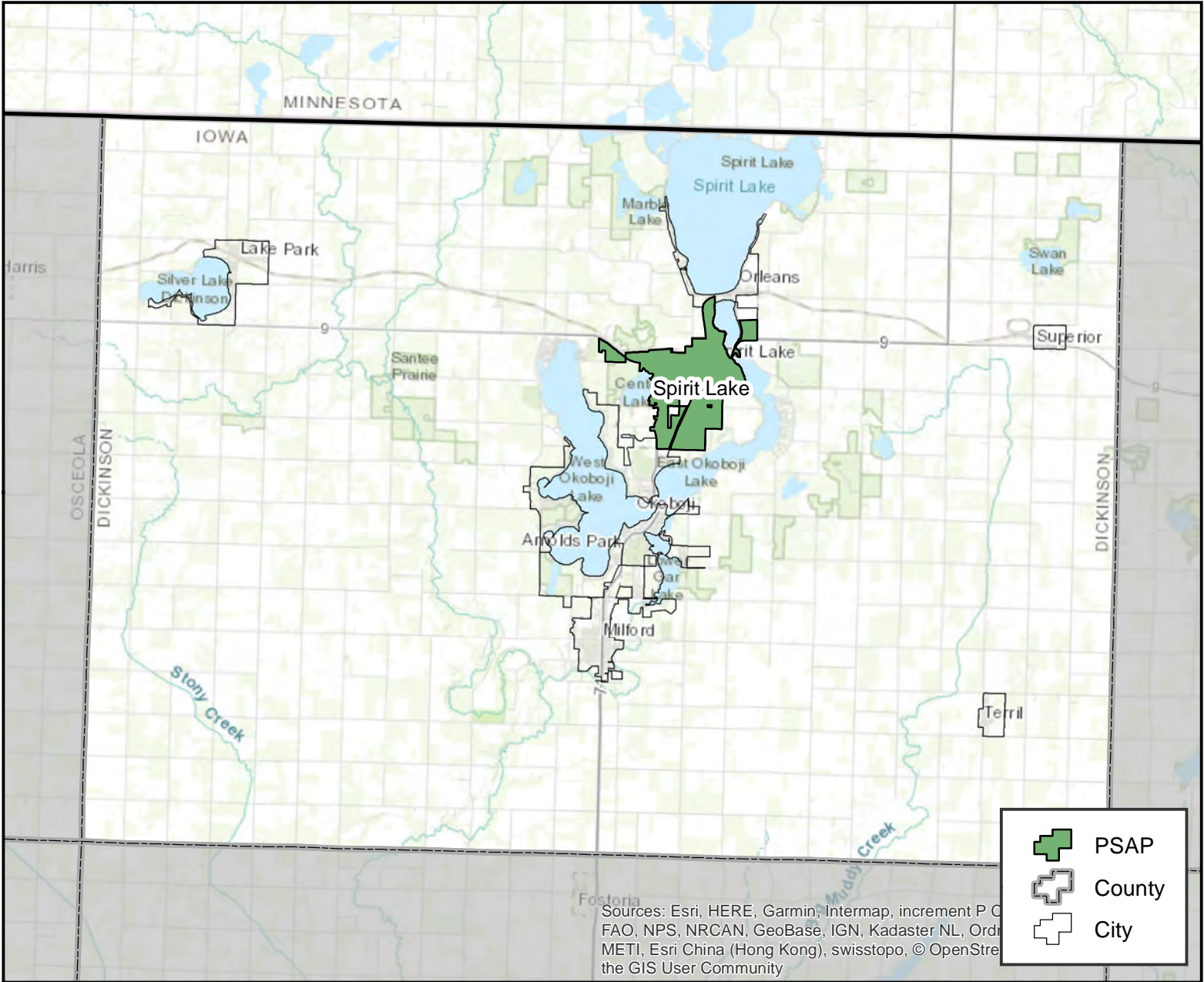

PSAP Information

Dickinson County Sheriff's Office
FCC #: 1938
Phone #: 712-336-2525
1802 Hill Avenue, Suite 1200 Spirit Lake, IA 51360

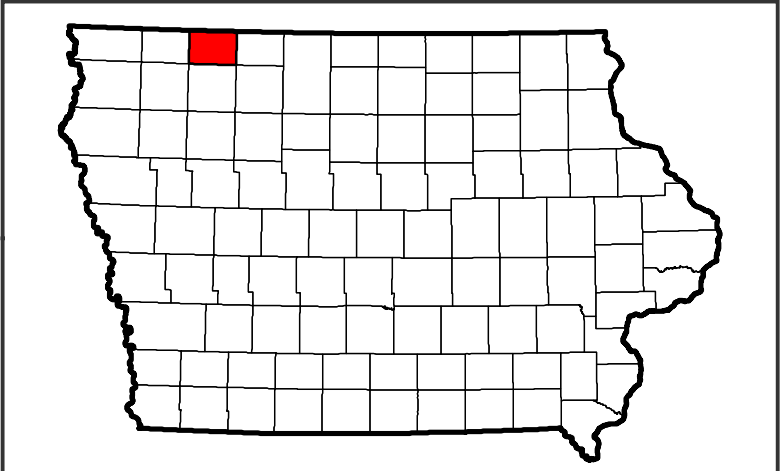

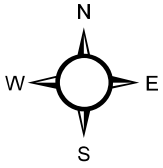

Dubuque County

Dubuque, Iowa

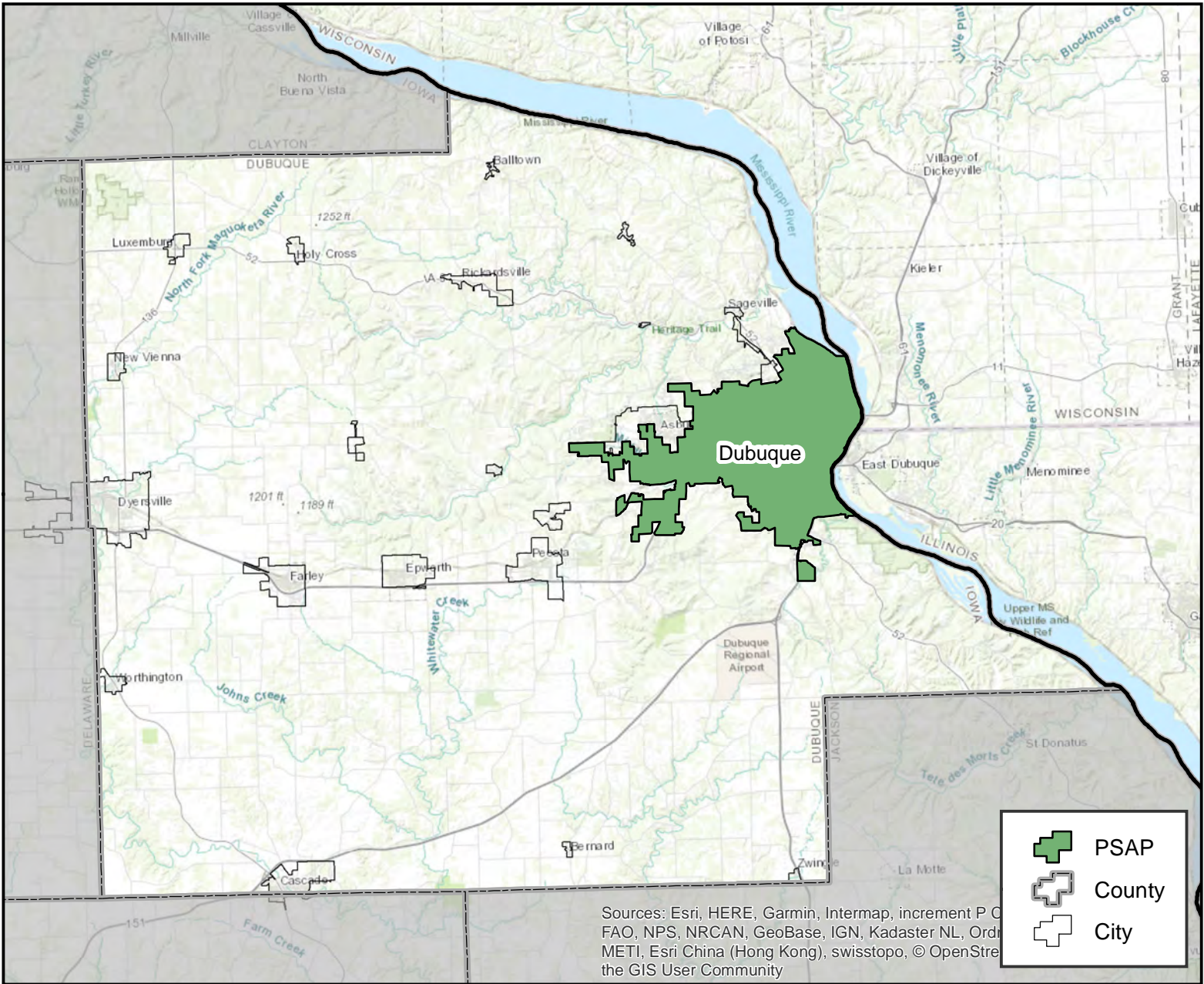

PSAP Information

Dubuque County Communications Center
FCC #: 1939
Phone #: 563-583-1711
770 Iowa St Dubuque, IA 52001

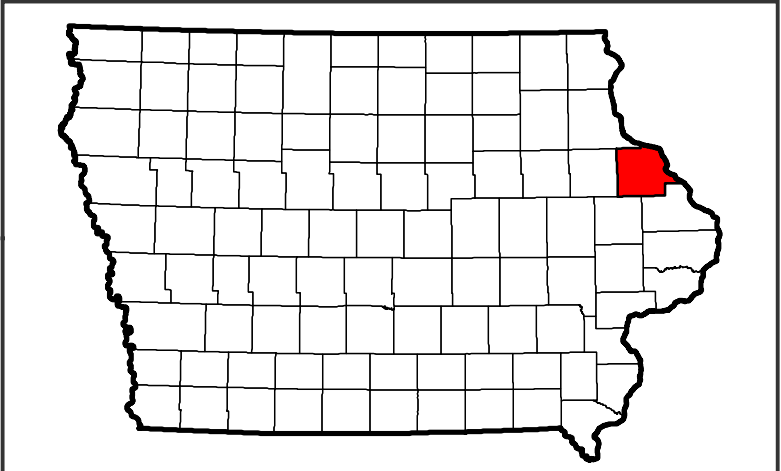

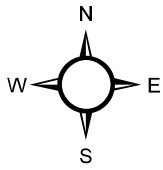

Emmet County

Estherville, Iowa

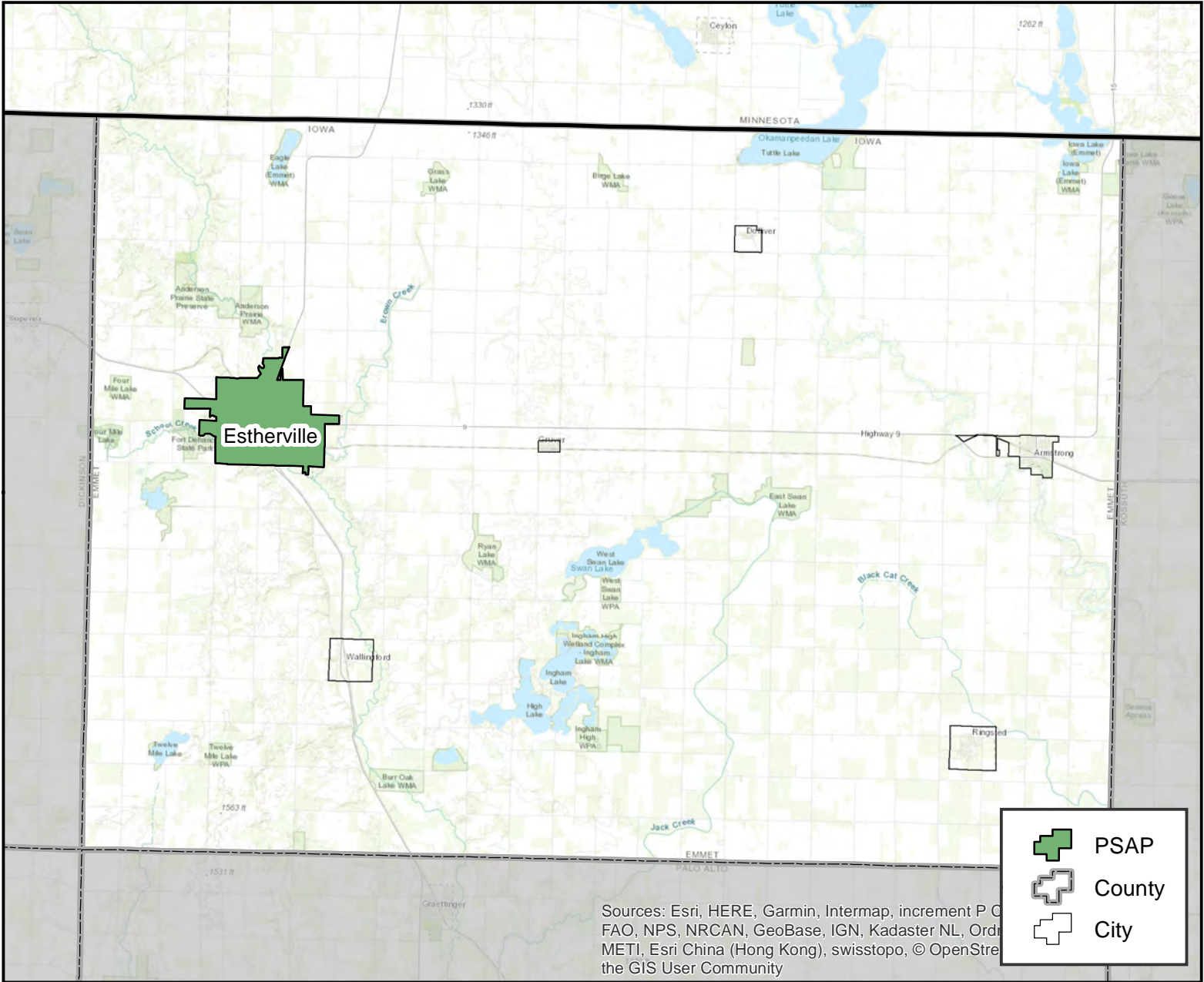

PSAP Information

Emmet County E911
FCC #: 1940
Phone #: 712-362-3515
114 North 6th Street Estherville, IA 51334

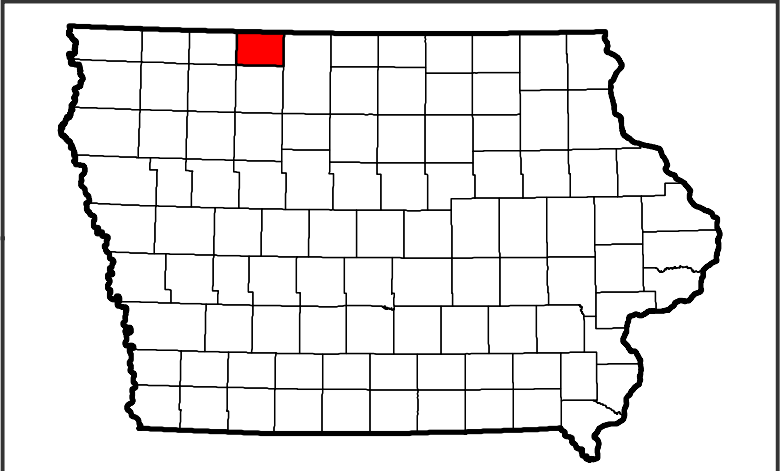

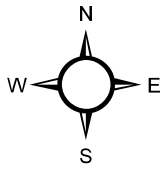

Fayette County

Oelwein, Iowa

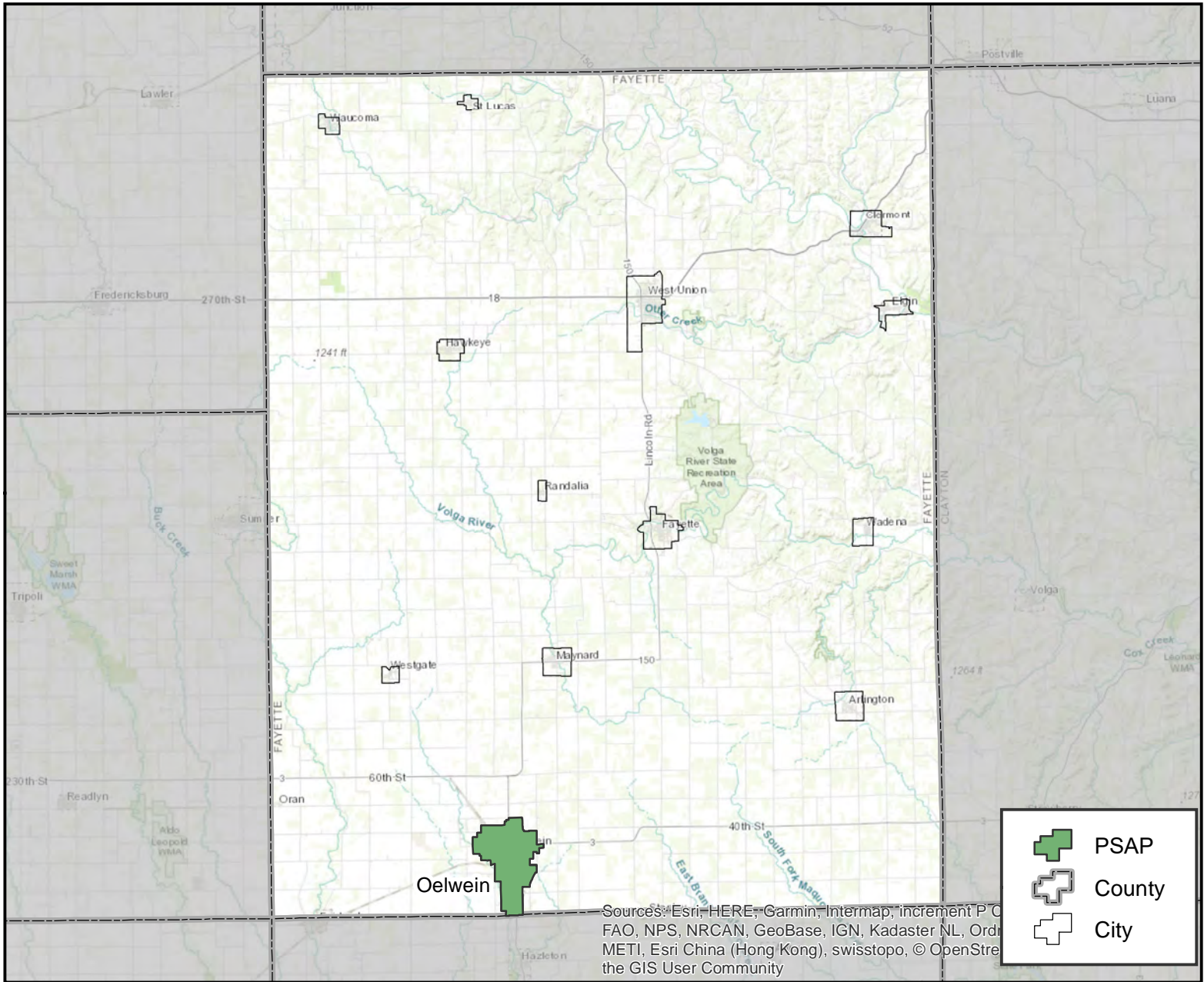

PSAP Information

Oelwein Police Department
FCC #: 1996
Phone #: 319-283-4311
501 Rock Island Rd Oelwein, IA 50662

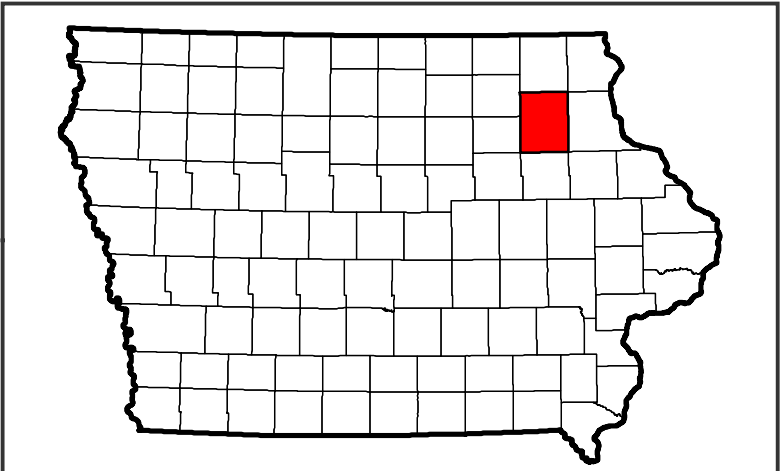

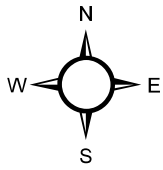

Fayette County

West Union, Iowa

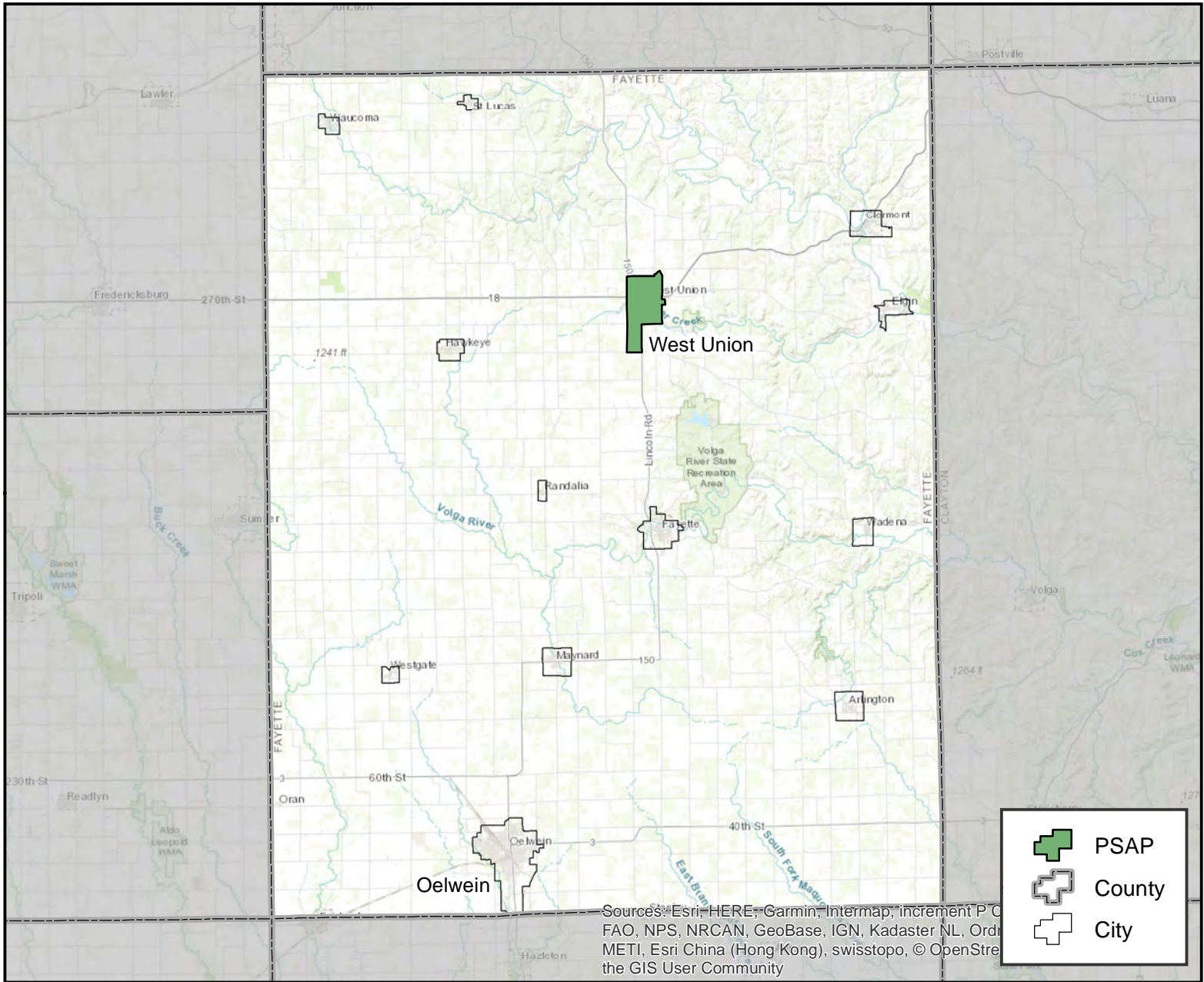

PSAP Information

Fayette County Sheriff's Office
FCC #: 1943
Phone #: 563-422-6128
220 N. Industrial Pkwy West Union, IA 52175

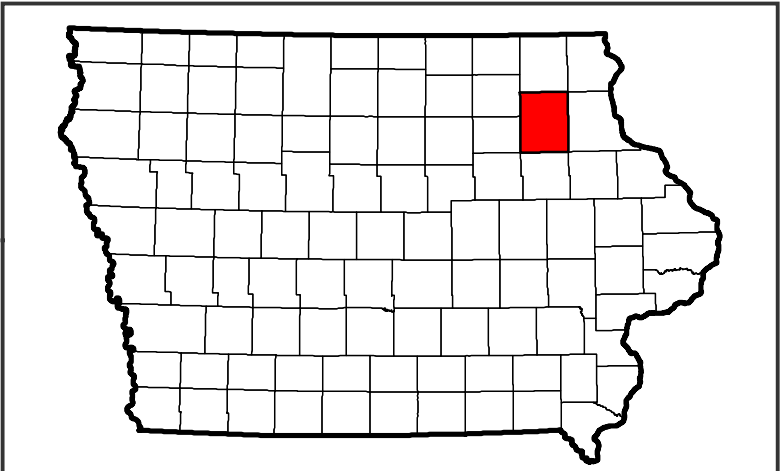

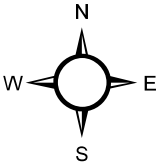

Floyd County

Charles City, Iowa

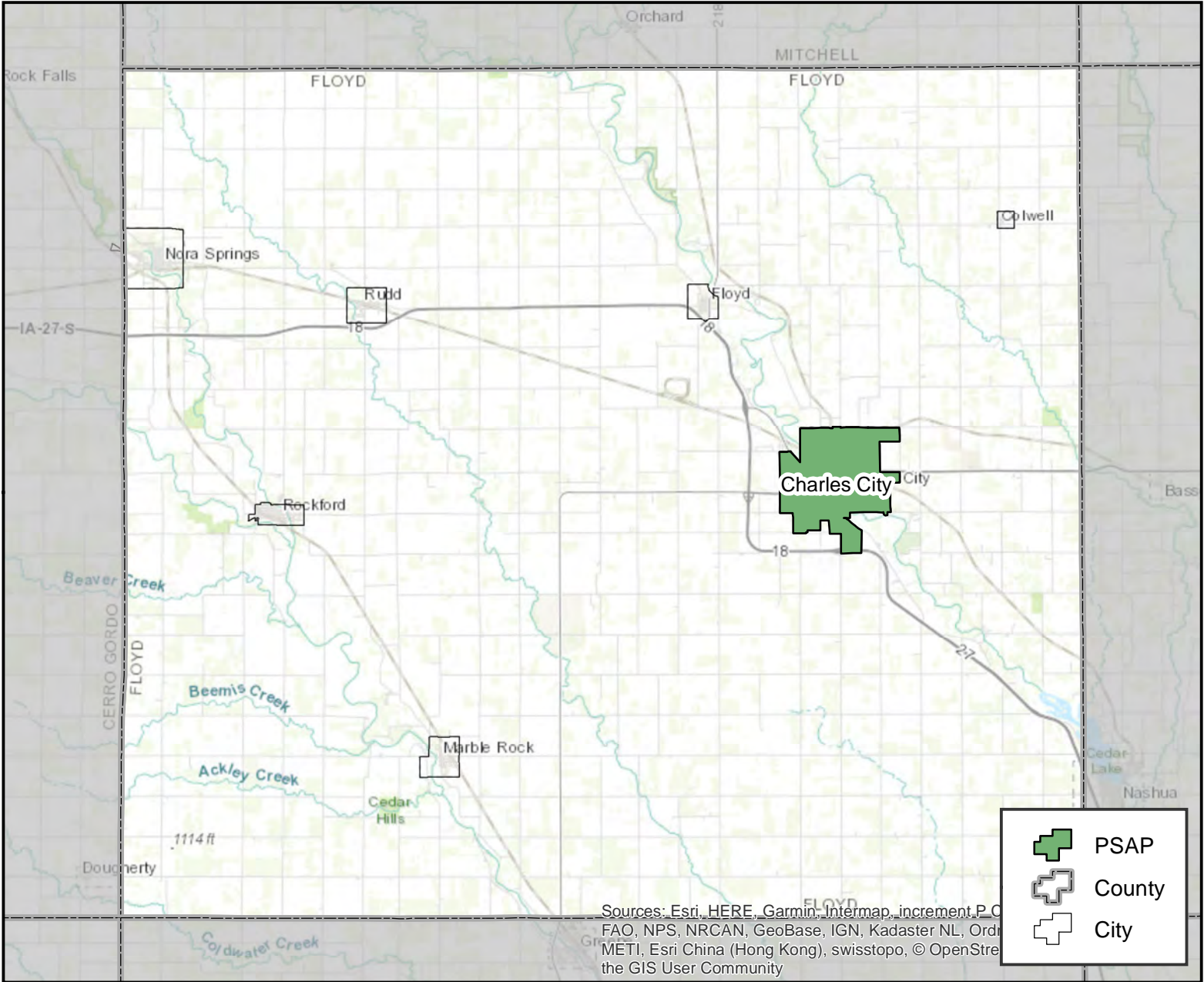

PSAP Information

Floyd County Communications Center
FCC #: 1917
Phone #: 641-228-3366
105 Milwaukee Mall Charles City, IA 50616

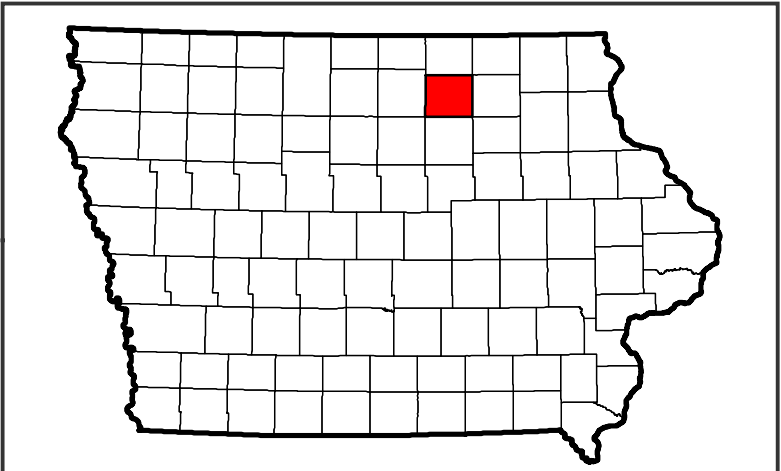

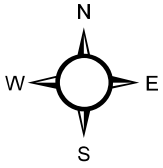

Franklin County

Hampton, Iowa

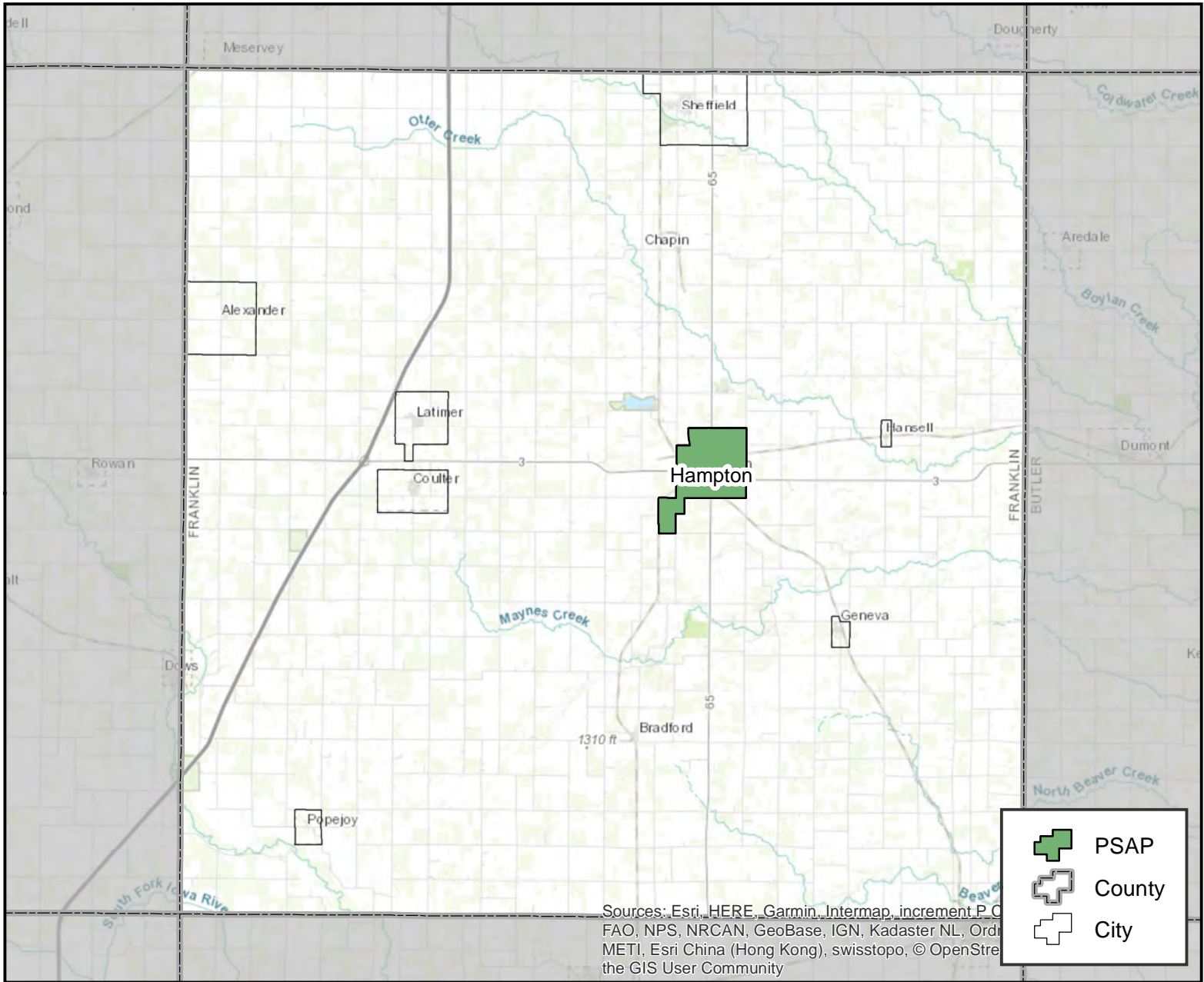

PSAP Information

Franklin Co. Emergency Management Communications
FCC #: 1953
Phone #: 641-456-2731
105 5th St. SW Hampton, IA 50441

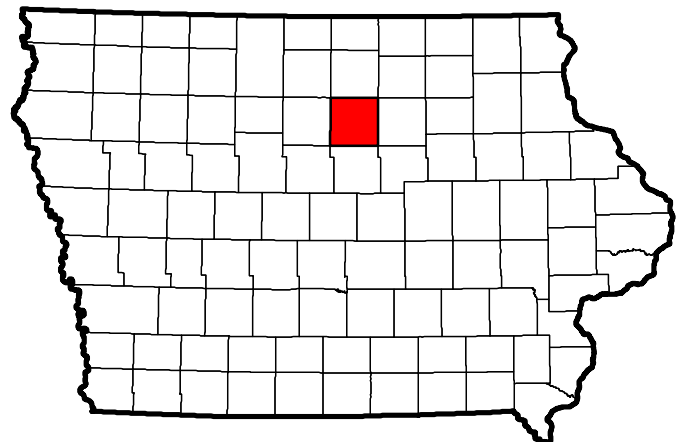

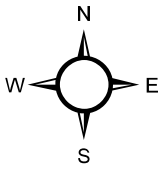

Fremont County

Sidney, Iowa

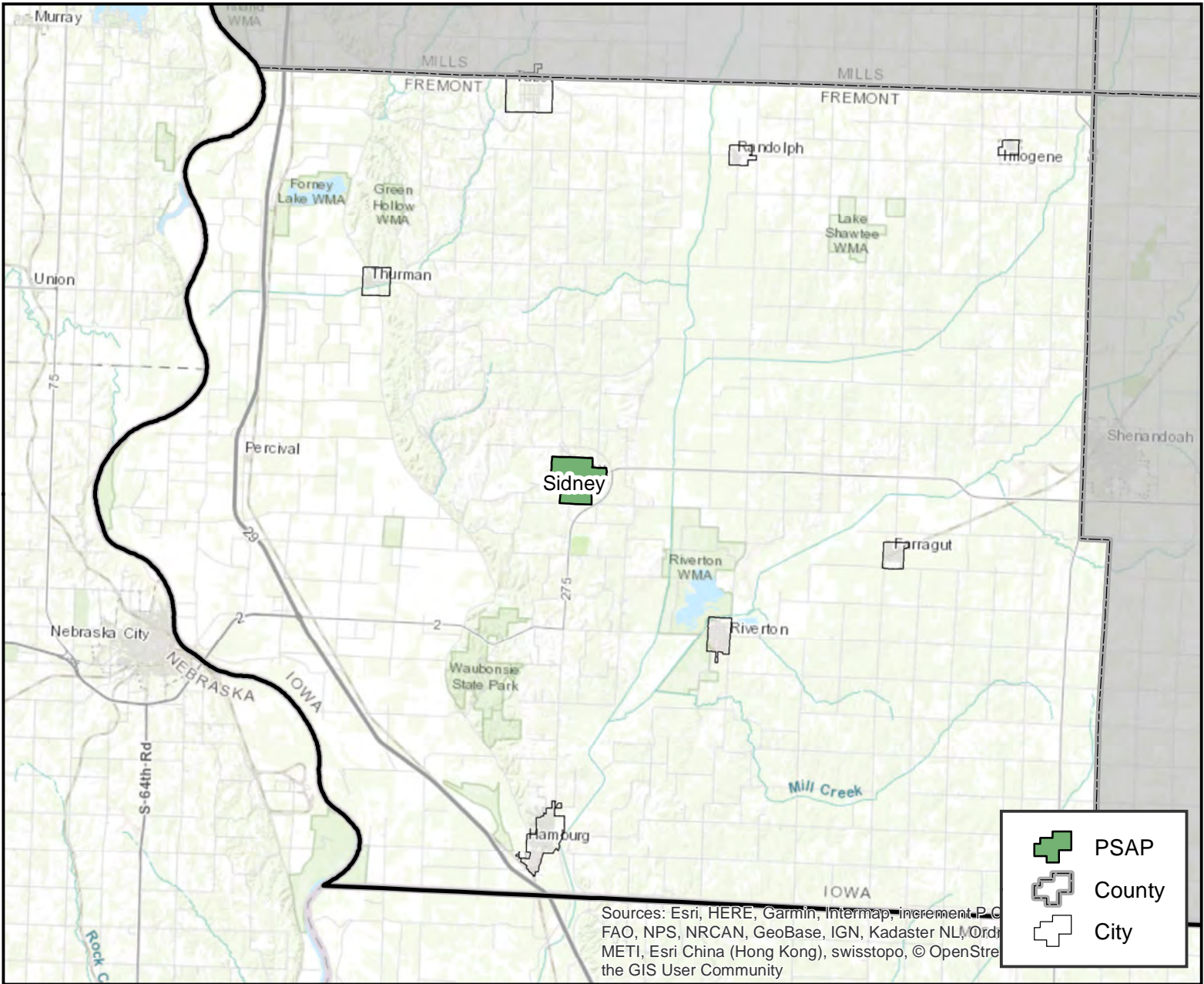

	PSAP
	County
	City

Sources: Esri, HERE, Garmin, Intermap, increment P.C., FAO, NPS, NRCAN, GeoBase, IGN, Kadaster NL, Ordnance Survey, Esri China (Hong Kong), swisstopo, © OpenStreetMap contributors, and the GIS User Community

PSAP Information

Fremont County Sheriff's Office
FCC #: 1945
Phone #: 712-374-2424
2814 200th Street Sidney, IA 51652

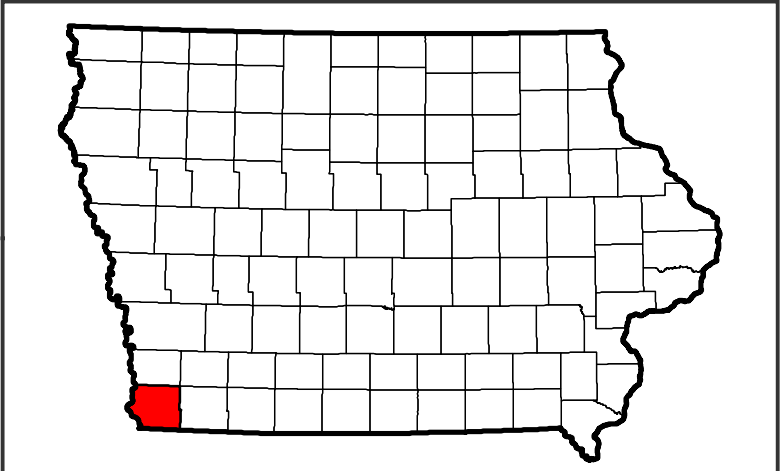

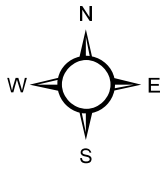

Greene County

Jefferson, Iowa

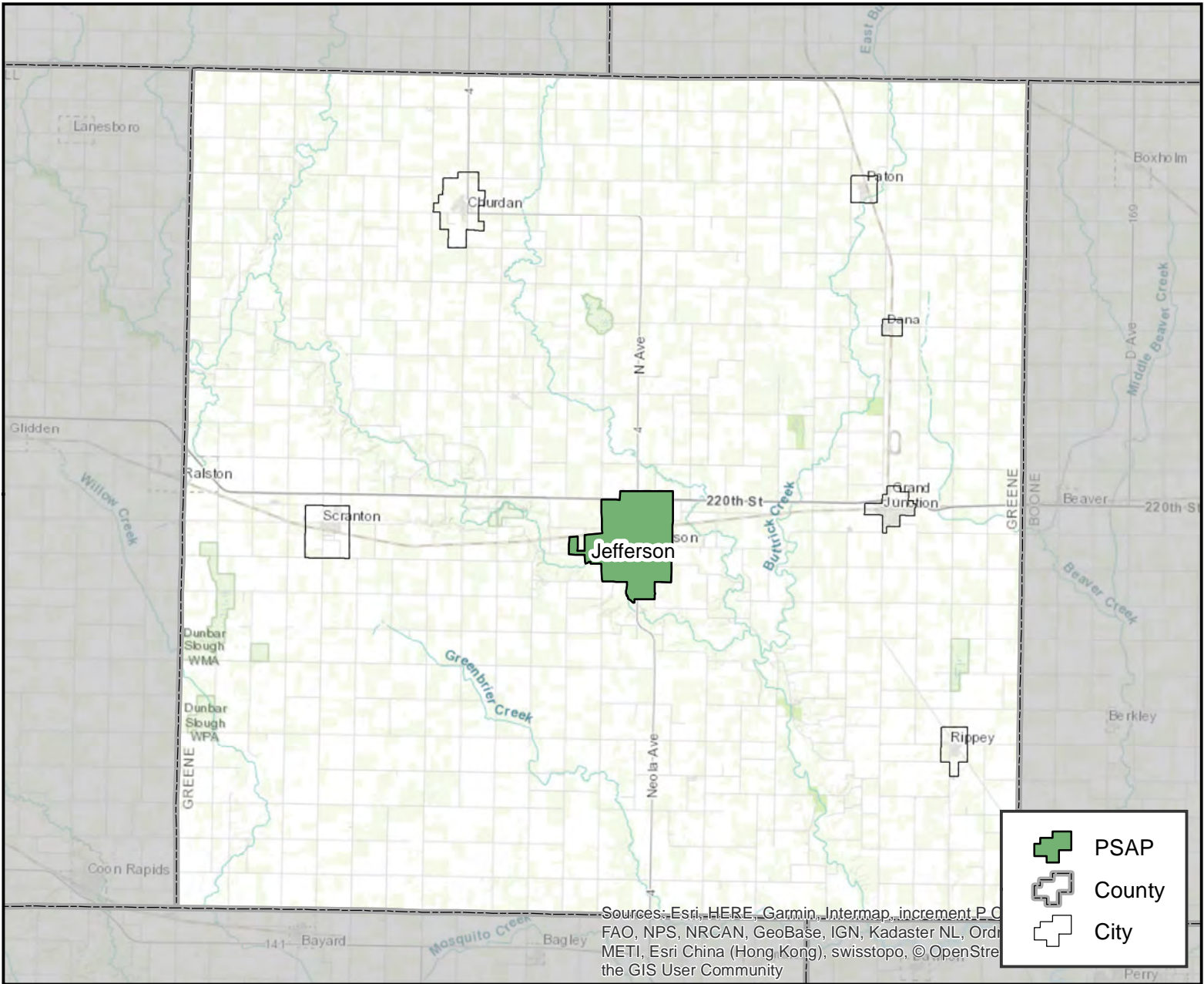

PSAP Information

Greene Co Sheriff's Office
FCC #: 1948
Phone #: 515-386-2136
204 S Chestnut St Jefferson, IA 50129

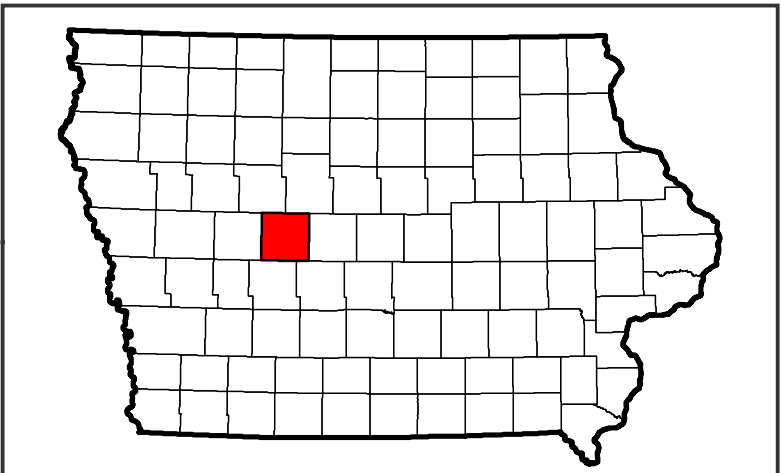

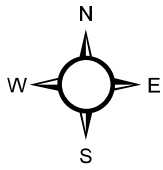

Grundy County

Grundy Center, Iowa

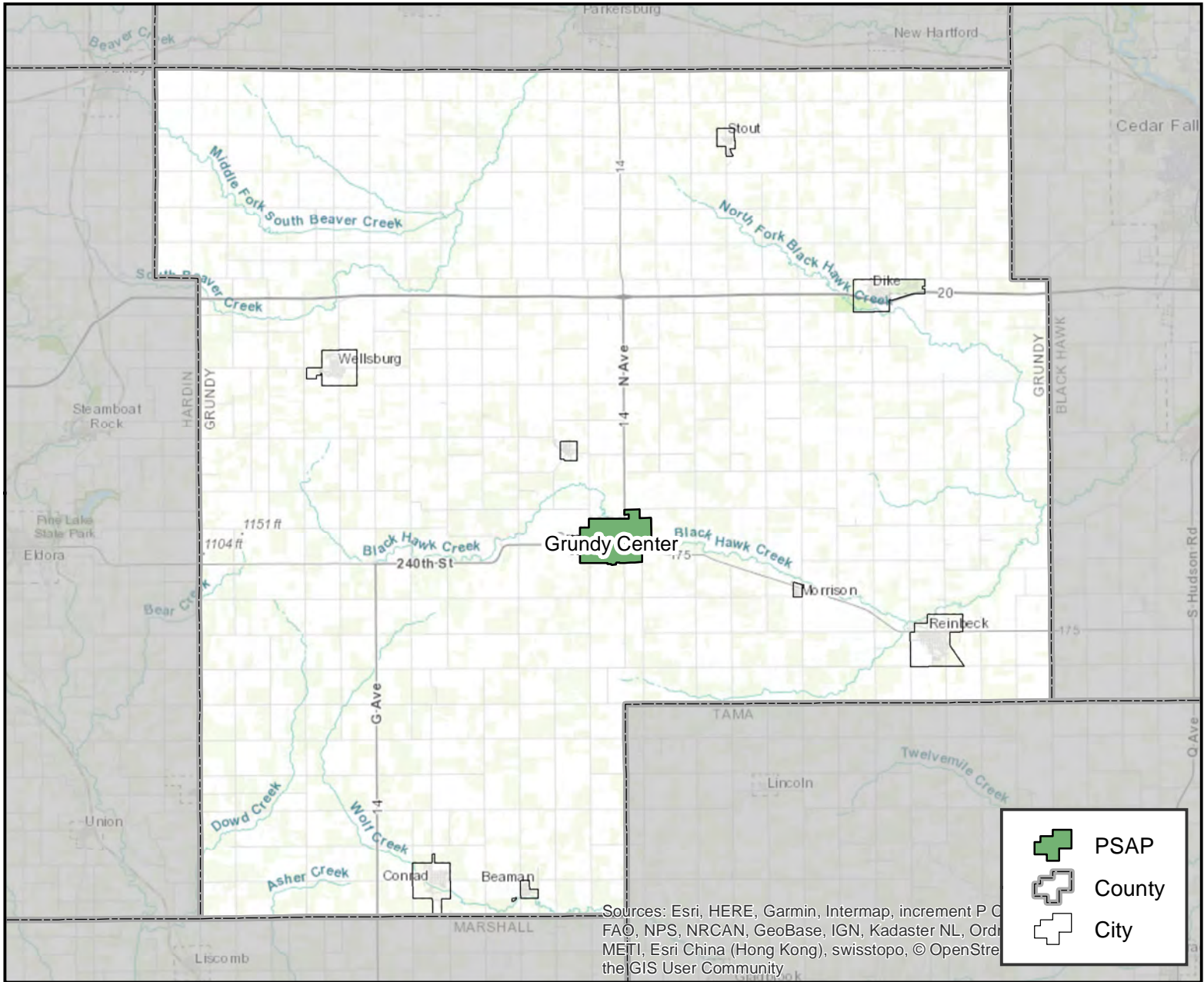

PSAP Information

Grundy Co Sheriff's Office
FCC #: 1949
Phone #: 319-824-6933
705 8th Street Grundy Center, IA 50638

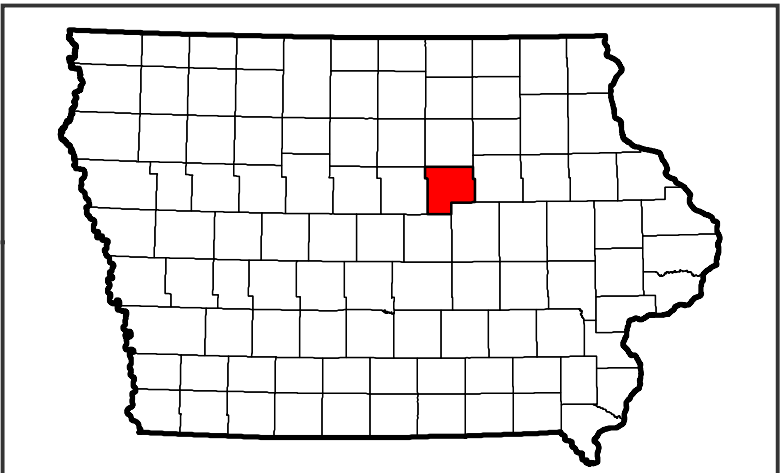

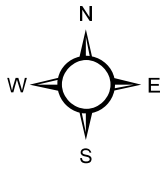

Guthrie County

Guthrie Center, Iowa

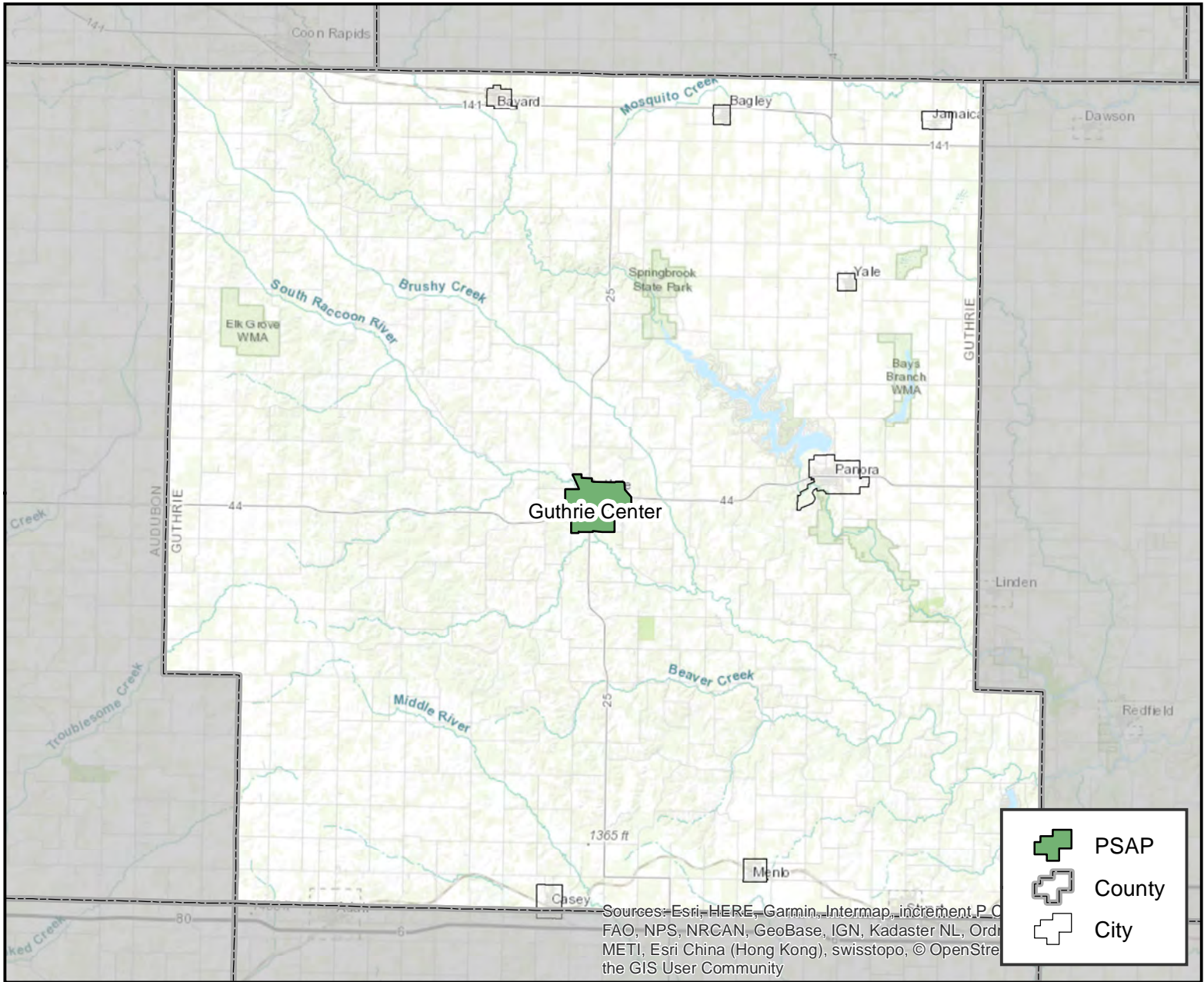

PSAP Information

Guthrie County Sheriff's Office
FCC #: 1950
Phone #: 641-747-2214
200 N 5th St Ste 7 Guthrie Center, IA 50115

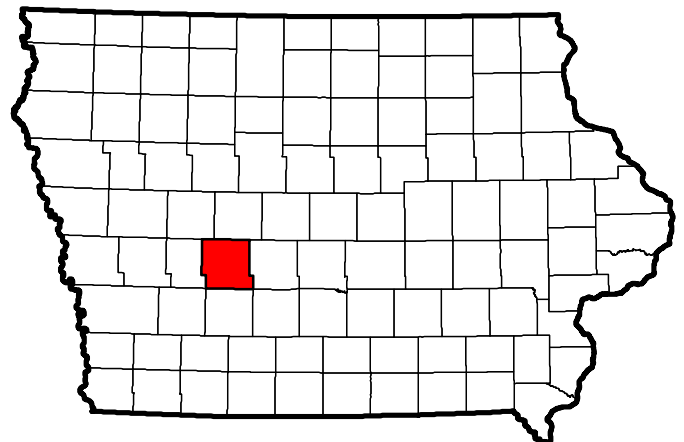

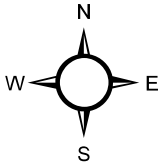

Hamilton County

Webster City, Iowa

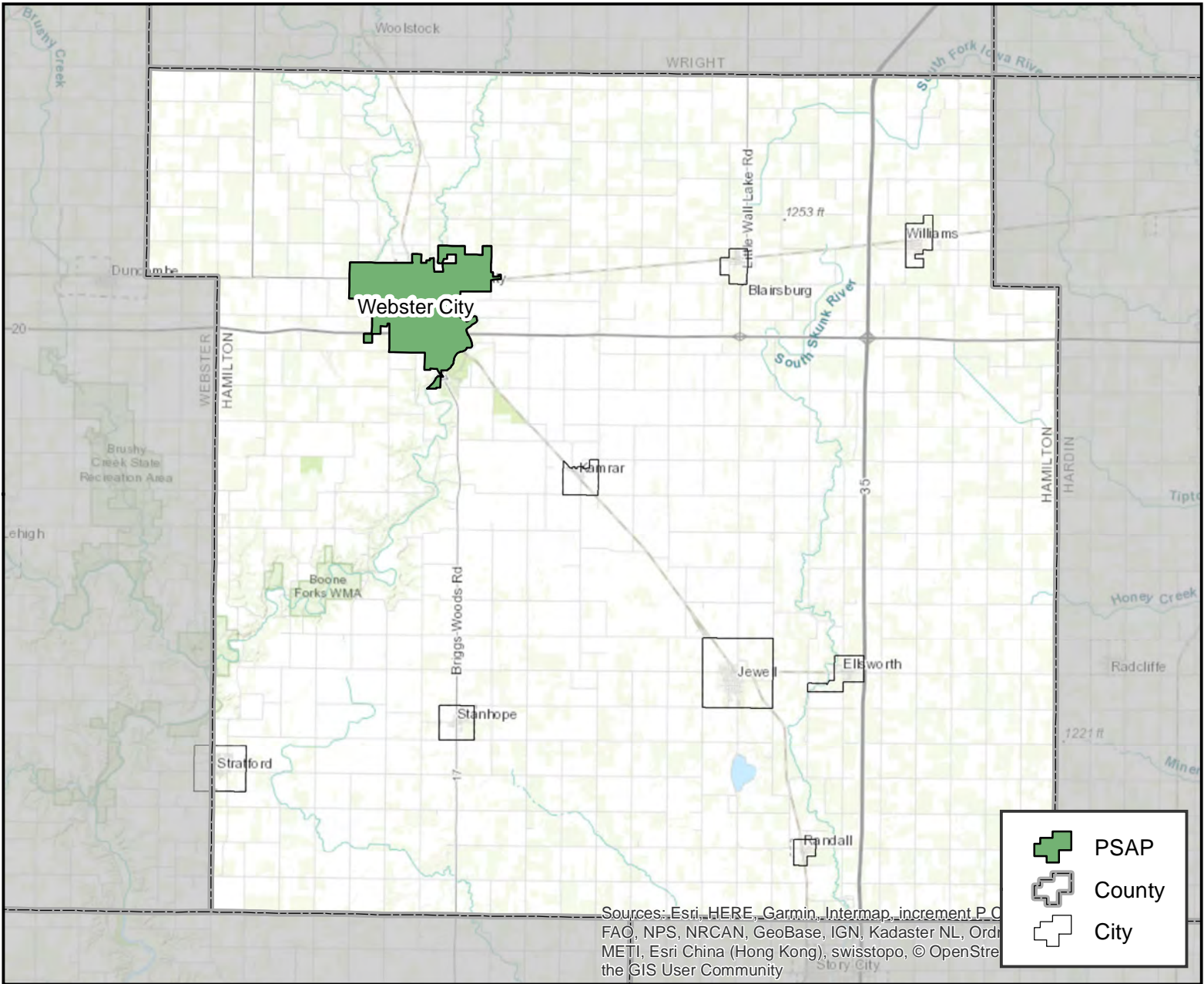

PSAP Information

Hamilton County Sheriff's Office
FCC #: 2026
Phone #: 515-832-9500
2300 Superior St., Ste. 8 Webster City, IA 50595

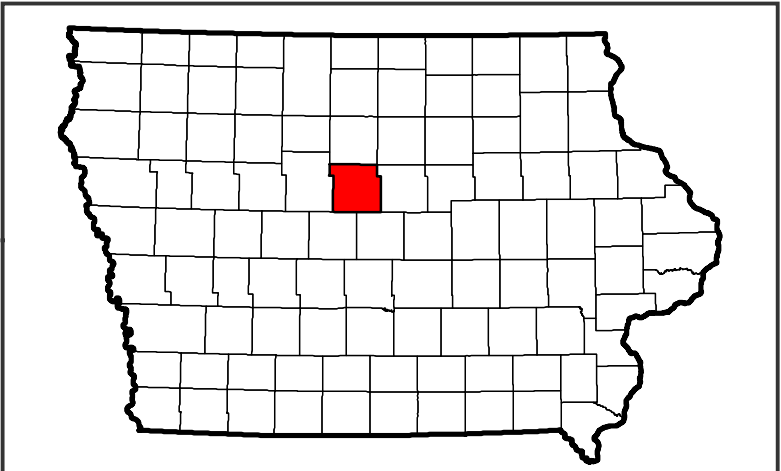

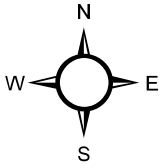

Hancock County

Garner, Iowa

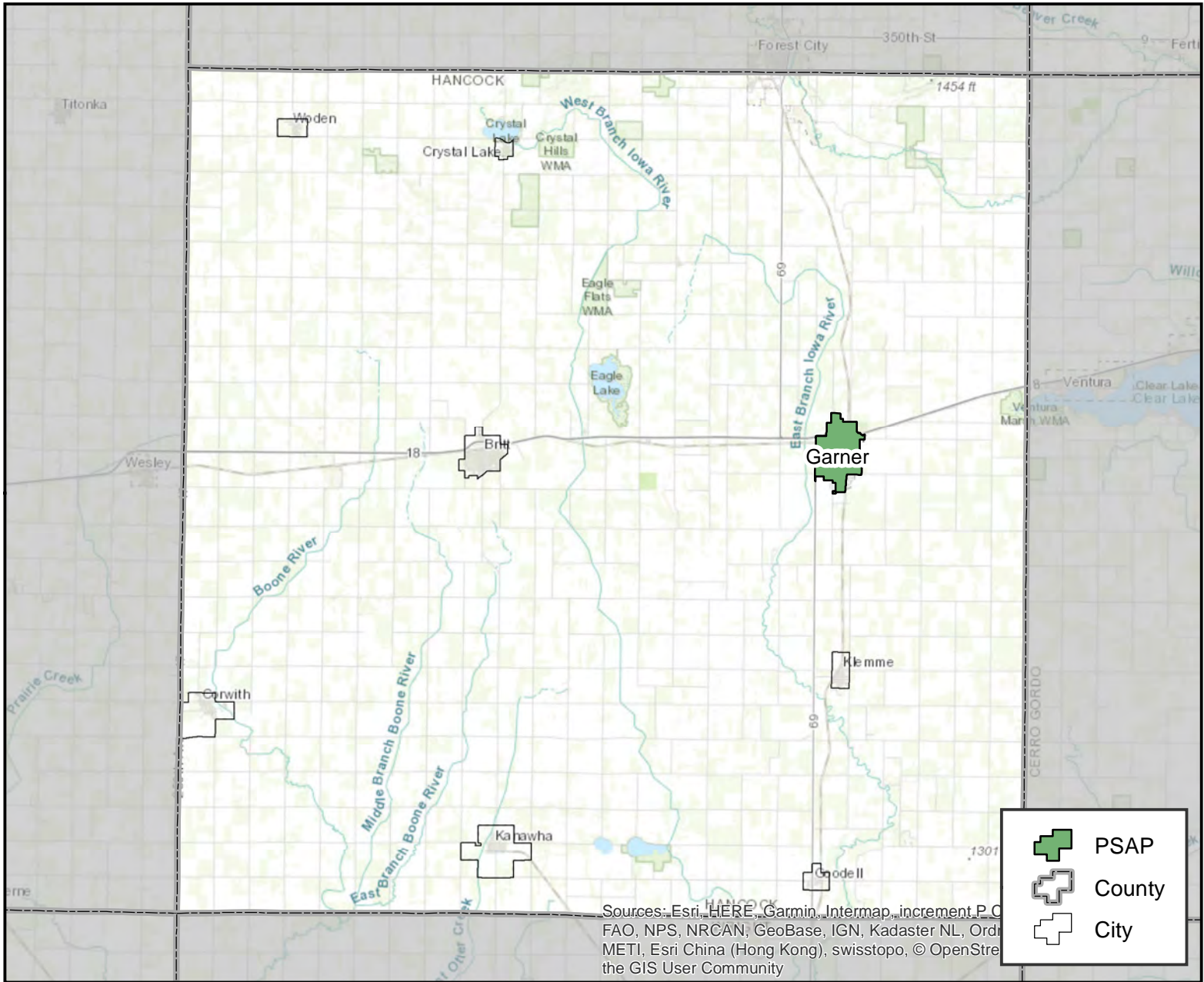

PSAP Information

Hancock Sheriffs Office
FCC #: 1954
Phone #: 641-923-2621
875 State Street Garner, IA 50438

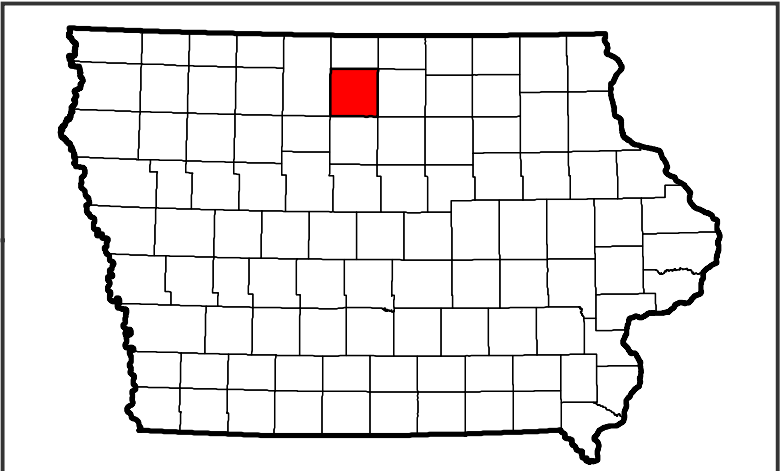

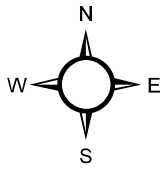

Hardin County

Eldora, Iowa

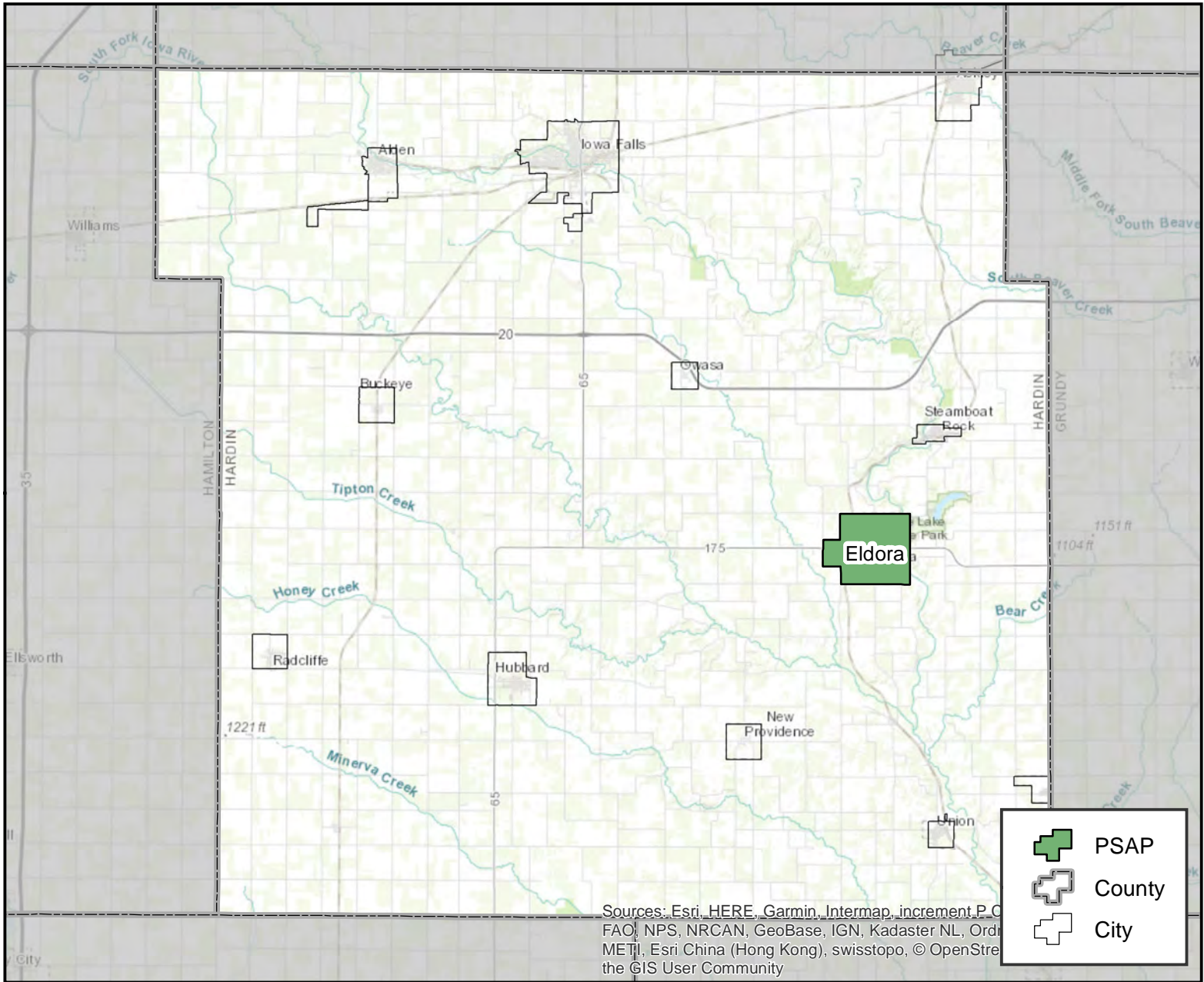

PSAP Information

Hardin County Sheriff
FCC #: 1955
Phone #: 641-939-8190
1116 14th Avenue Eldora, IA 50627

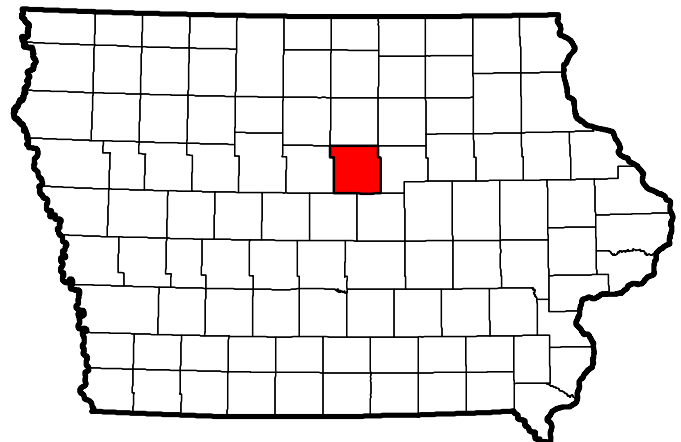

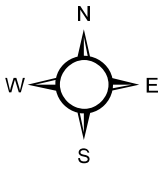

Hardin County

Iowa Falls, Iowa

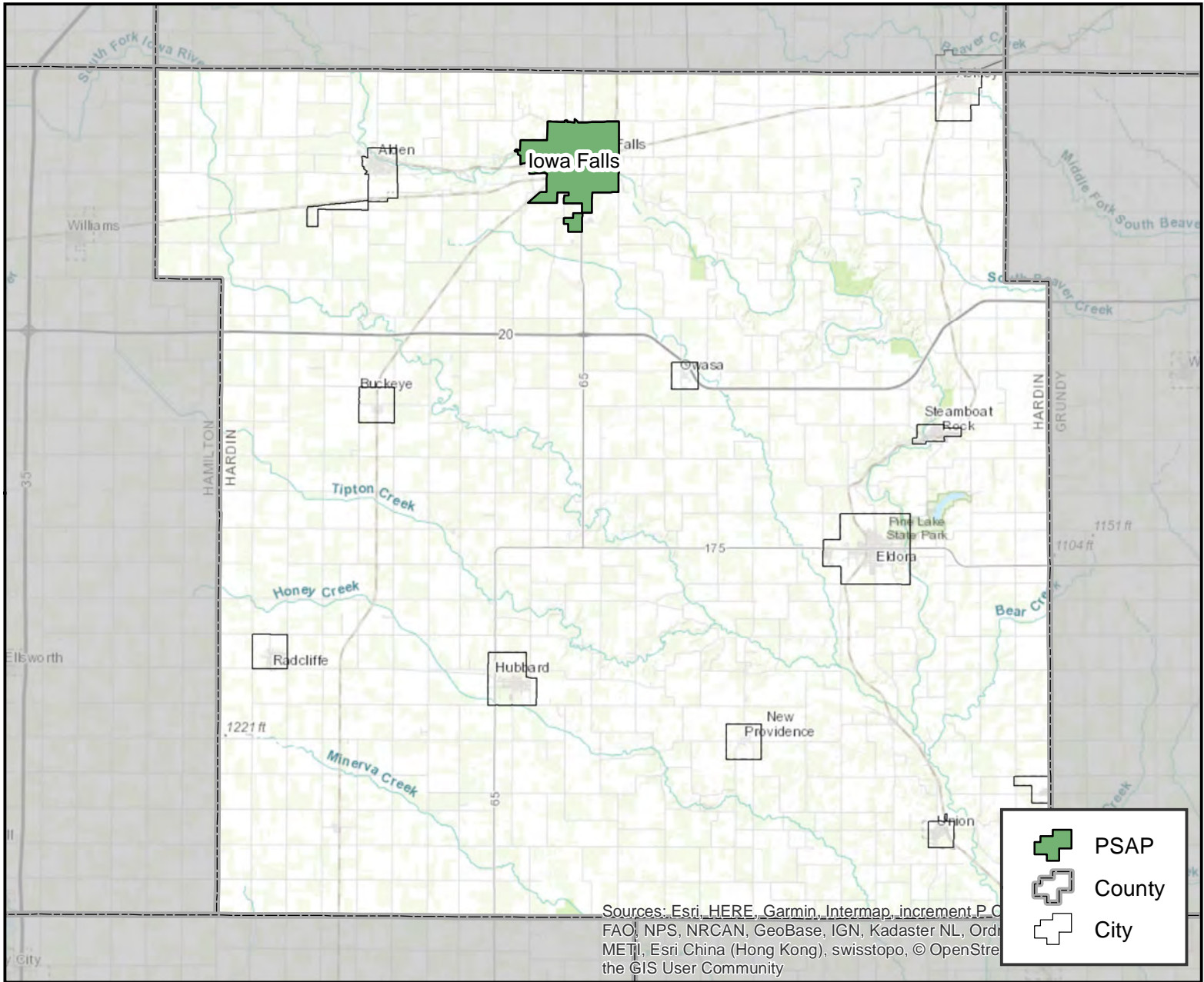

PSAP Information

Iowa Falls Police Department
FCC #: 1965
Phone #: 641-648-6464
321 Stevens Street Iowa Falls, IA 50126

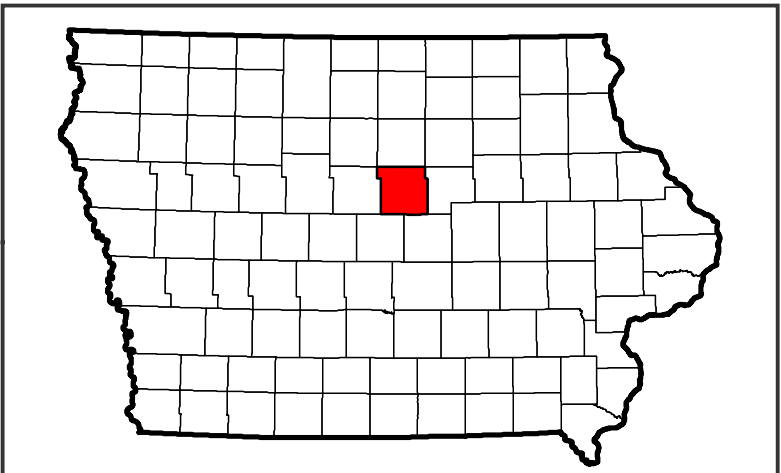

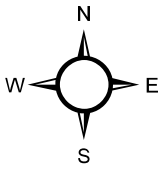

Harrison County

Logan, Iowa

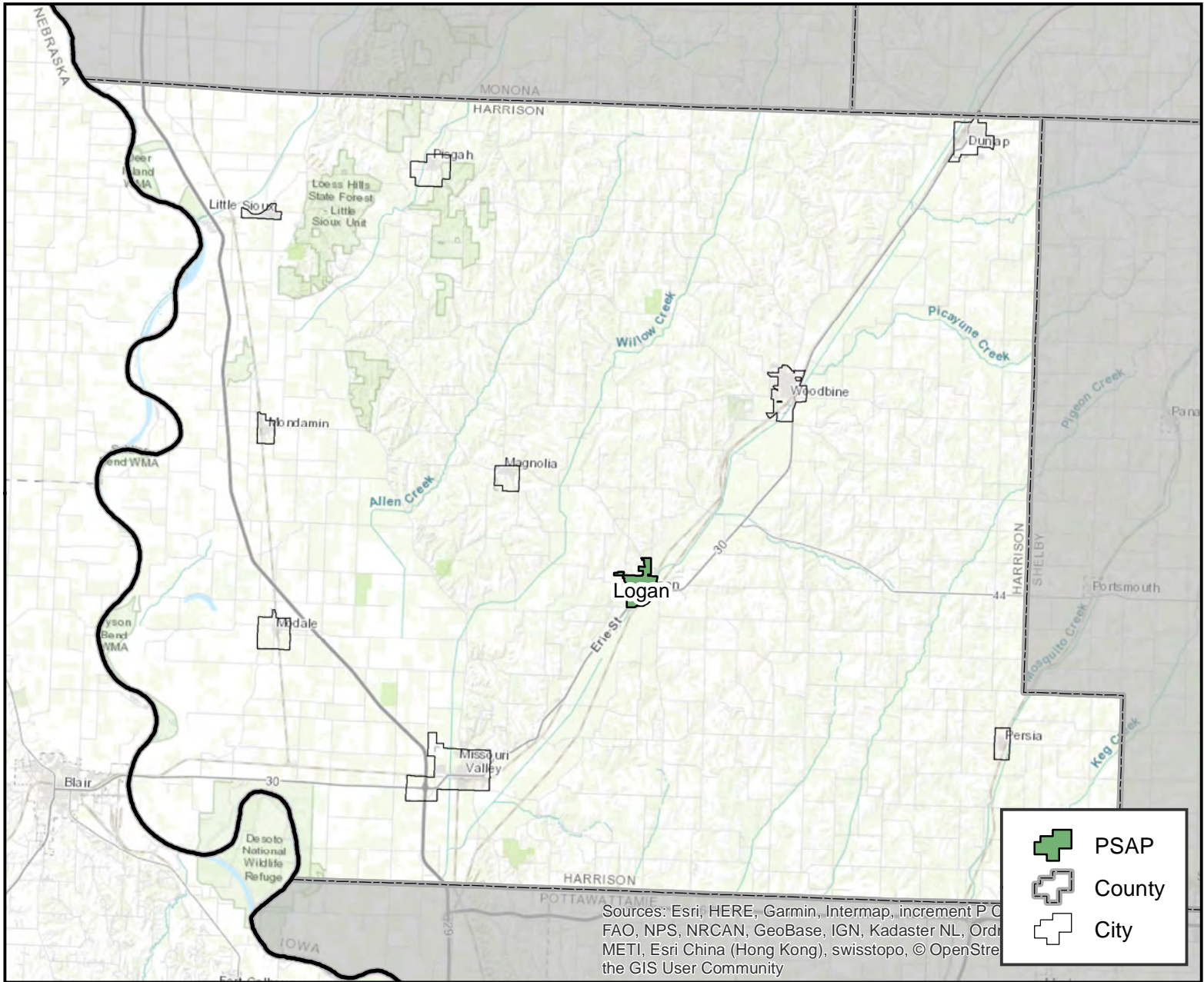

PSAP Information

Harrison County Communications
FCC #: 1956
Phone #: 712-644-2353
111 S 1st ave Logan, IA 51546

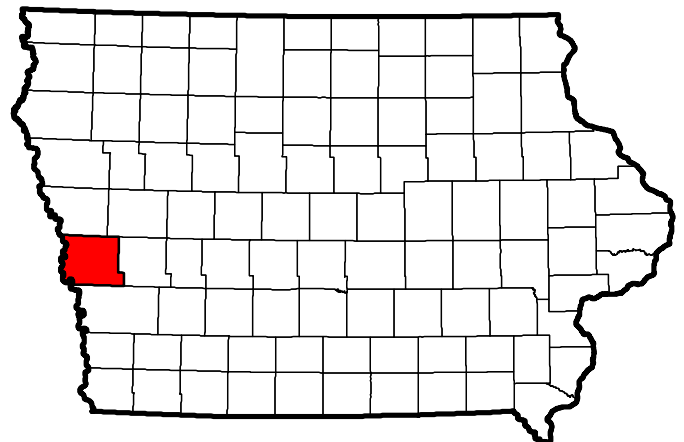

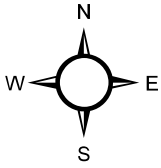

Henry County

Mount Pleasant, Iowa

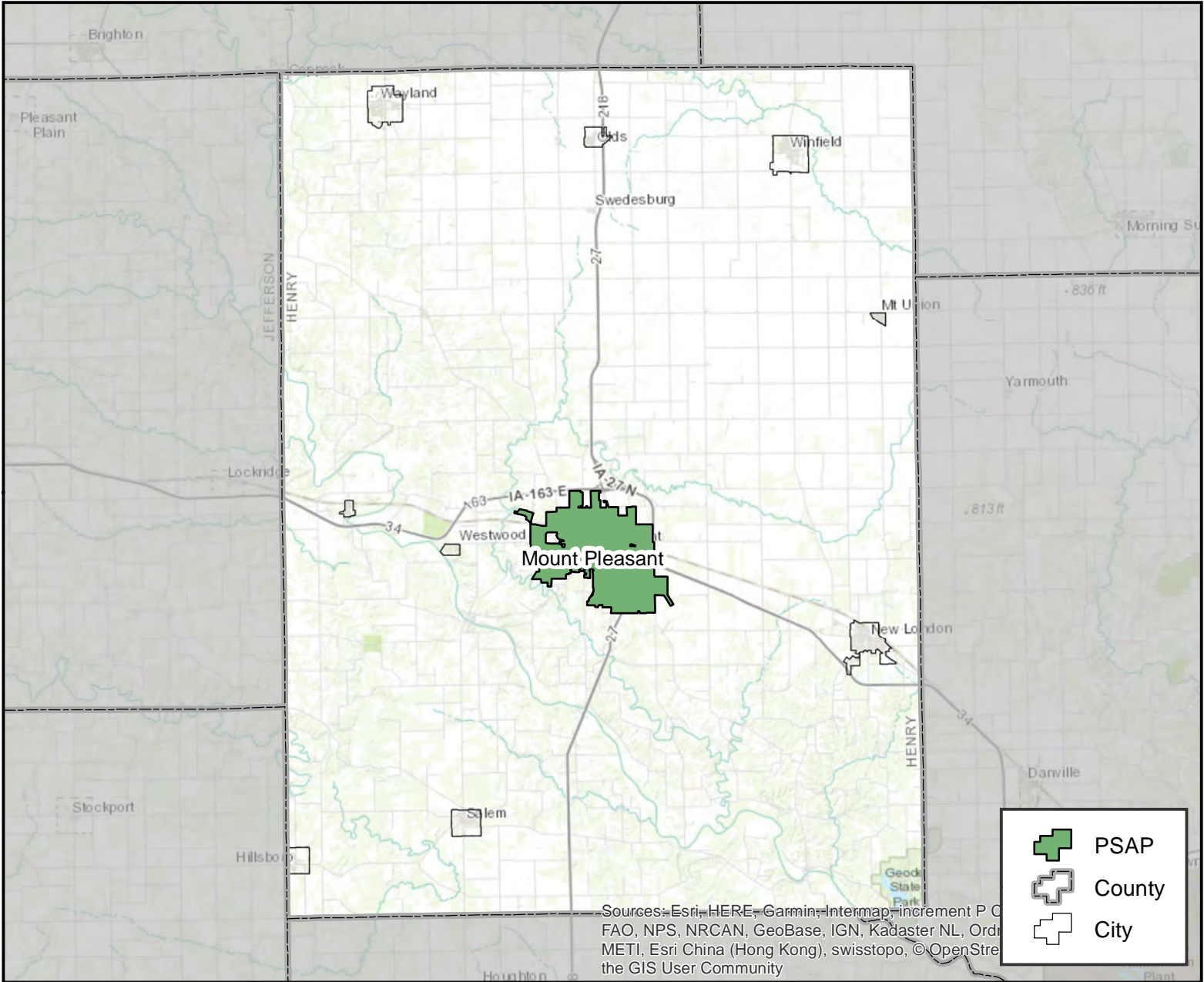

PSAP Information

Henry County Sheriff's Office
FCC #: 1957
Phone #: 319-385-2712
106 E Clay St Mt Pleasant, IA 52641

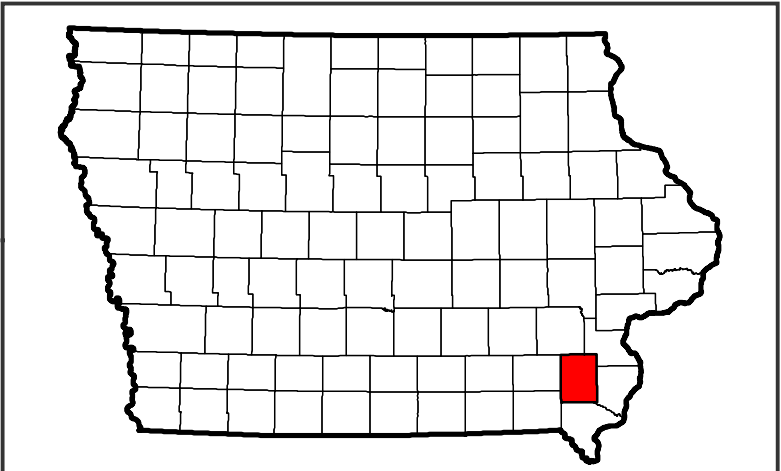

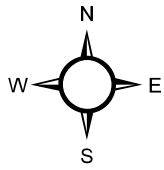

Howard County

Cresco, Iowa

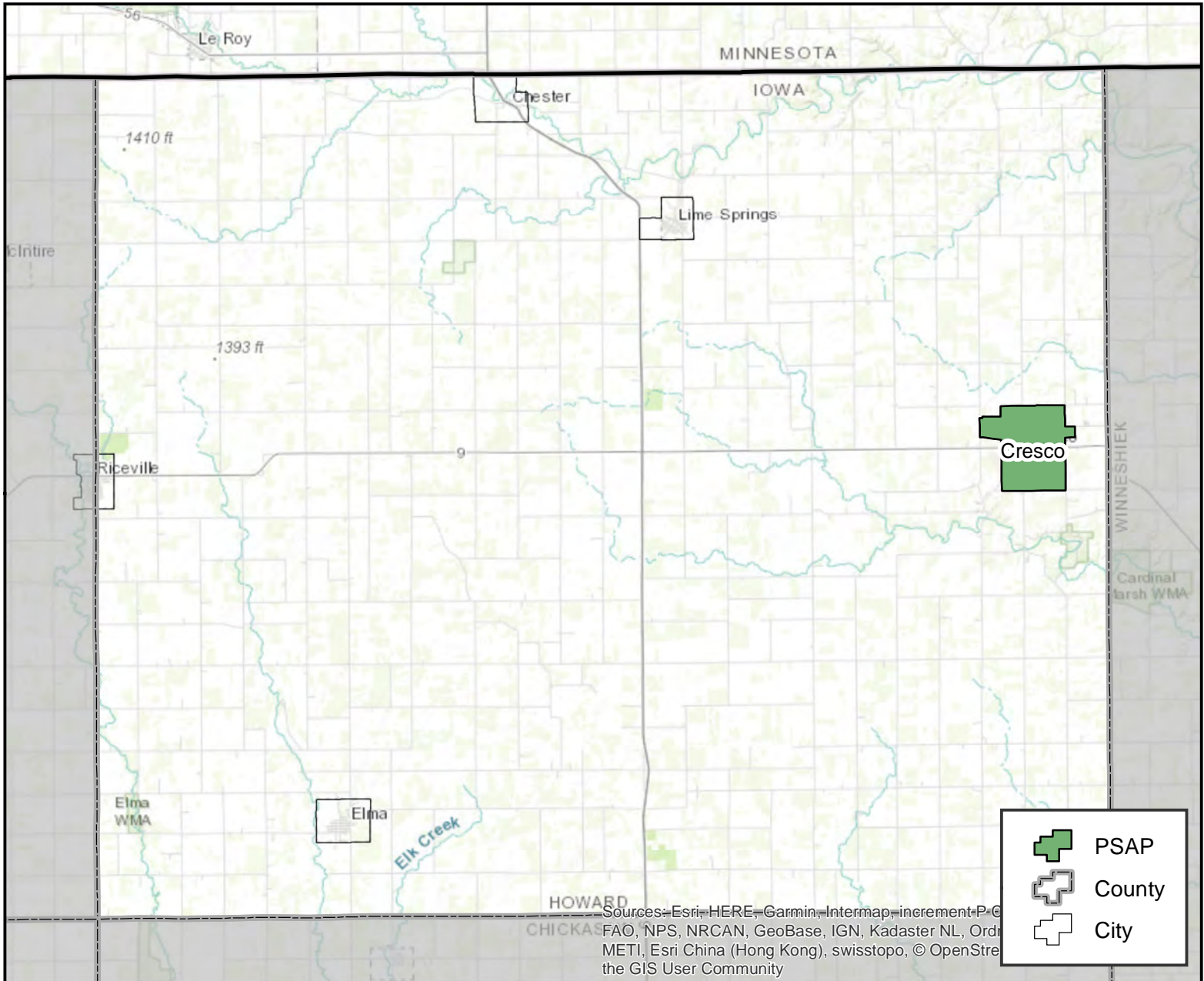

PSAP Information

Howard Co Sheriff Office
FCC #: 1958
Phone #: 563-547-3535
124 South Park Place Cresco, IA 52136

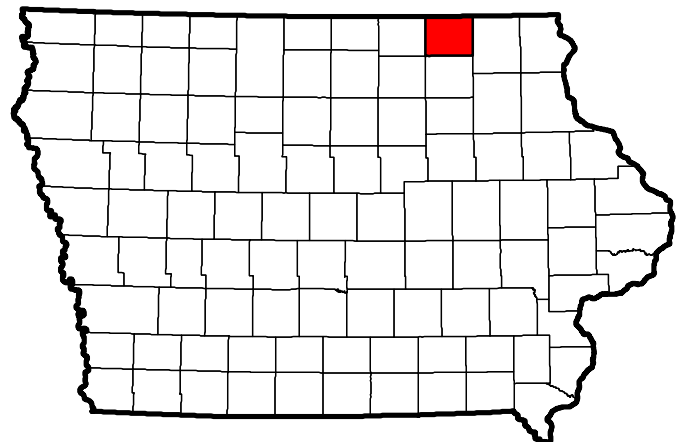

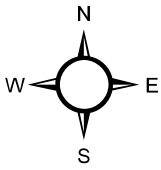

Humboldt County

Humboldt, Iowa

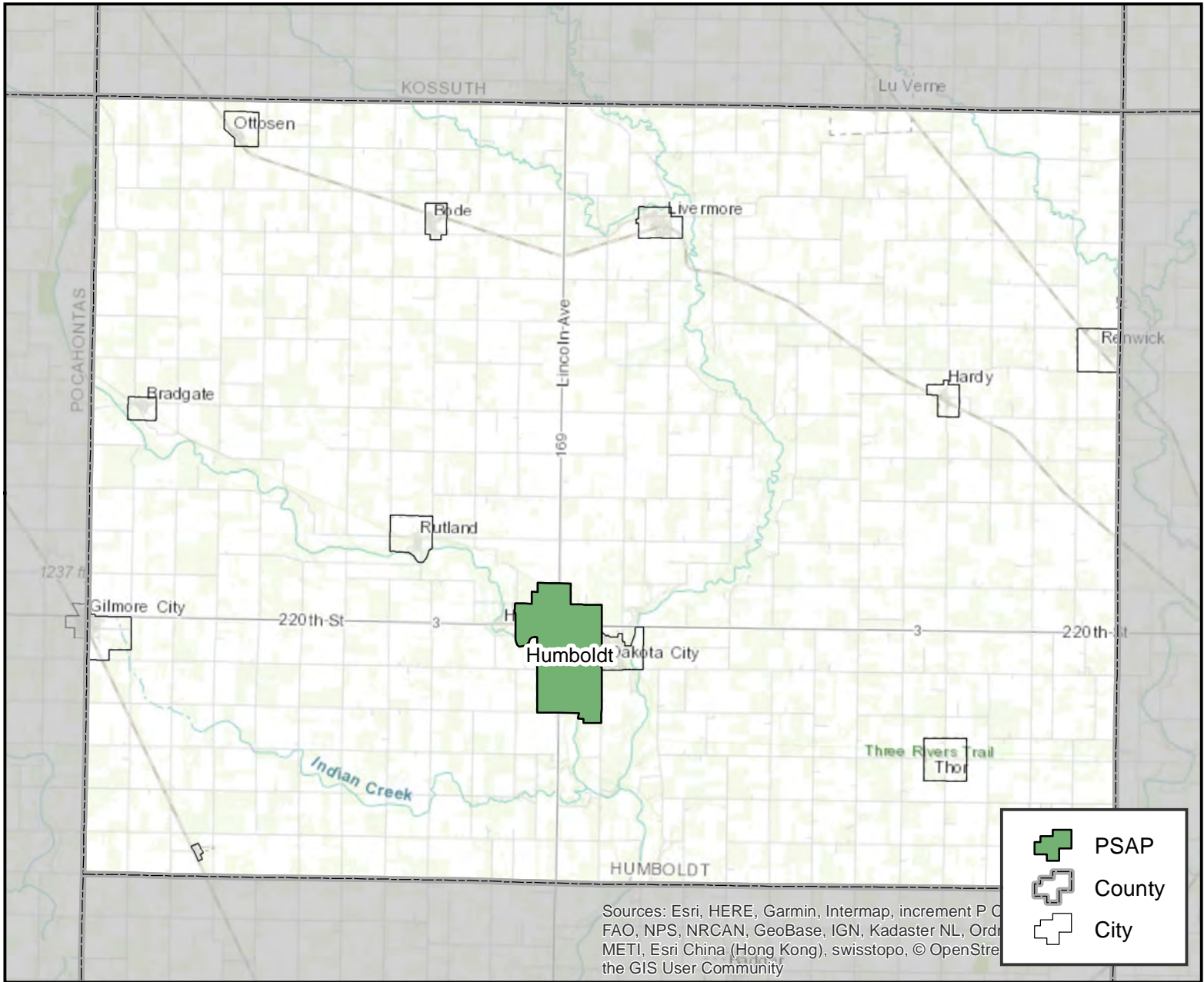

PSAP Information

Humboldt Co Law Enforcement Center
FCC #: 1959
Phone #: 515-332-2600
430 Sumner Ave Humboldt, IA 50548

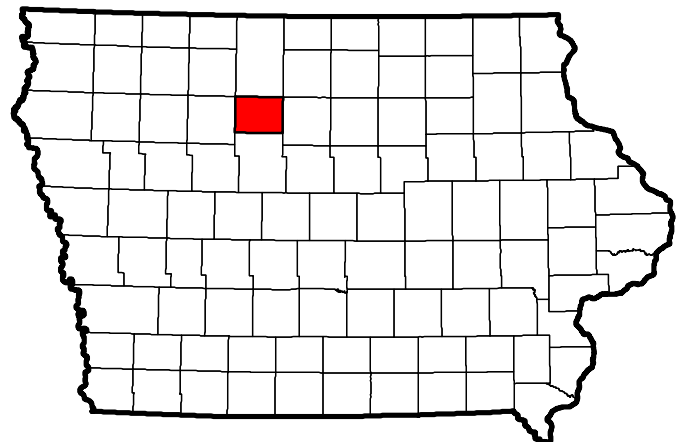

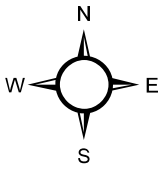

Ida County

Ida Grove, Iowa

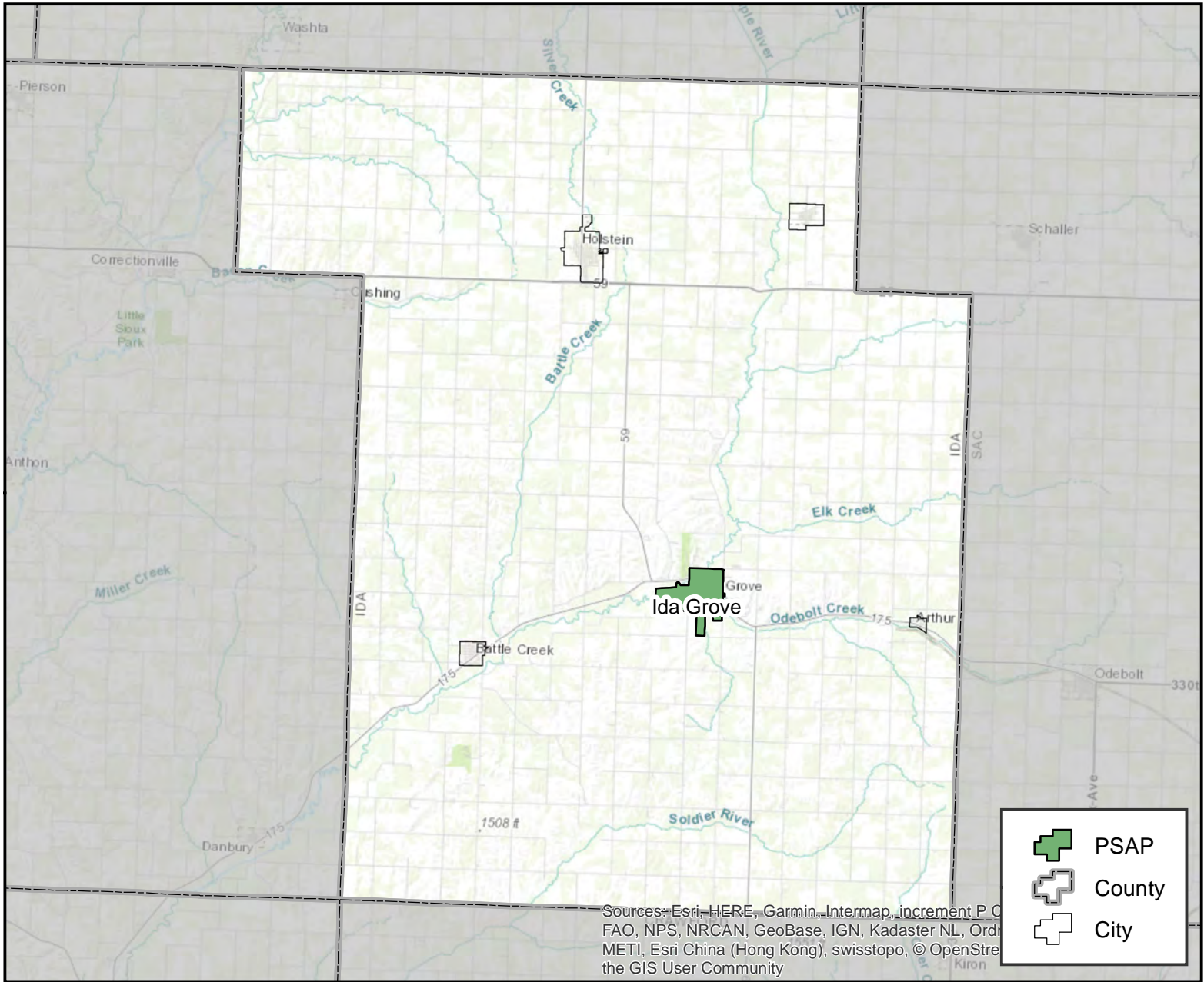

PSAP Information

Ida Co Sheriff's Office
FCC #: 1960
Phone #: 712-364-3146
401 Moorehead St Ida Grove, IA 51445

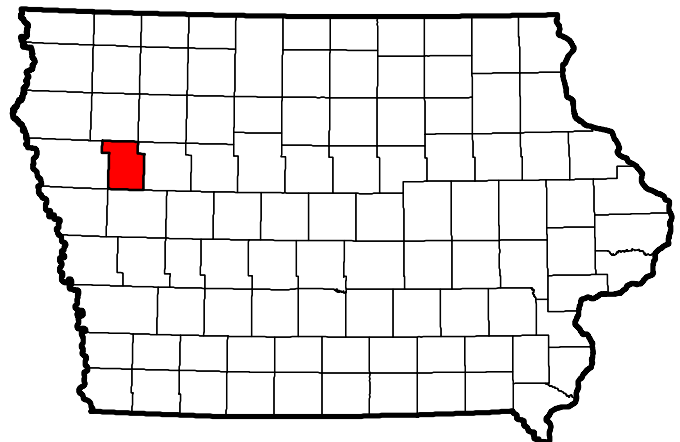

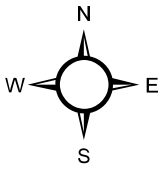

Iowa County

Marengo, Iowa

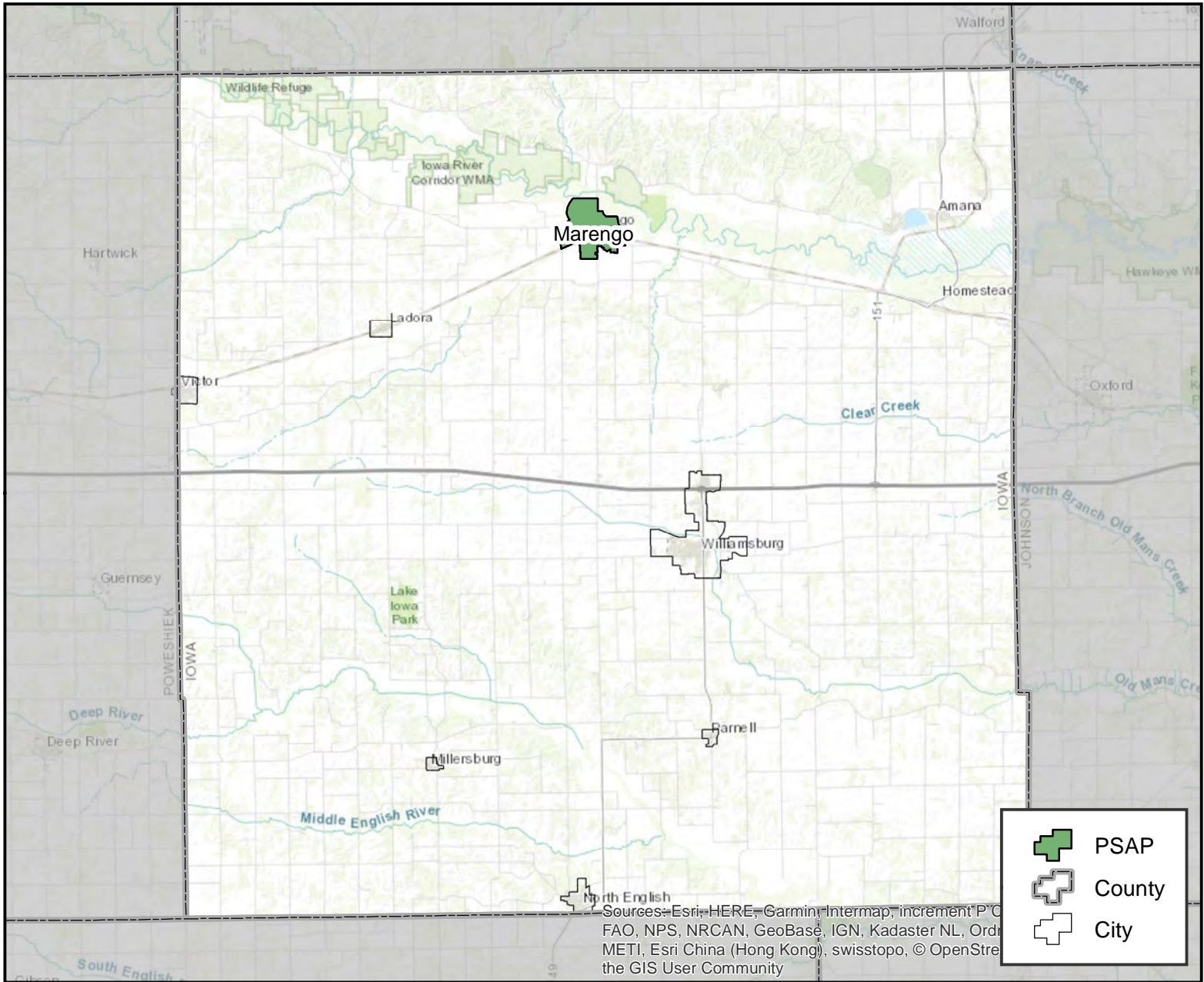

PSAP Information

Iowa County Sheriff's Office
FCC #: 1962
Phone #: 319-642-7307
960 Franklyn Ave Marengo, IA 52301

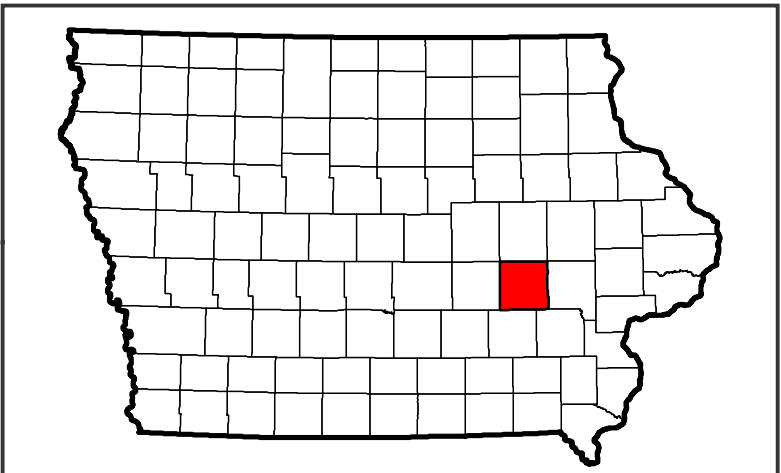

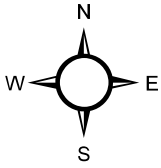

Jackson County

Maquoketa, Iowa

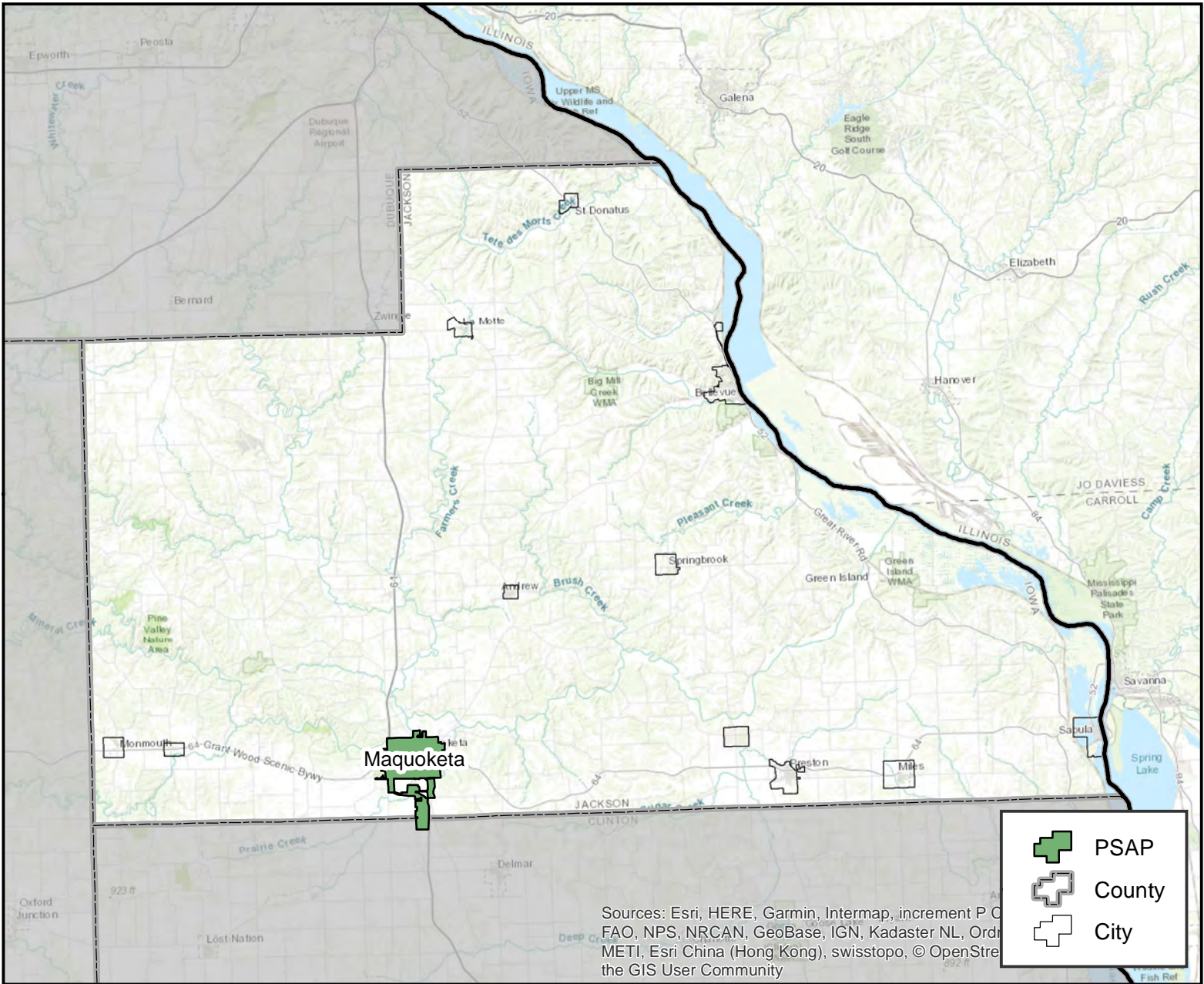

PSAP Information

Maquoketa Police Department
FCC #: 1982
Phone #: 563-652-2468
102 S Niagara St Maquoketa, IA 52060

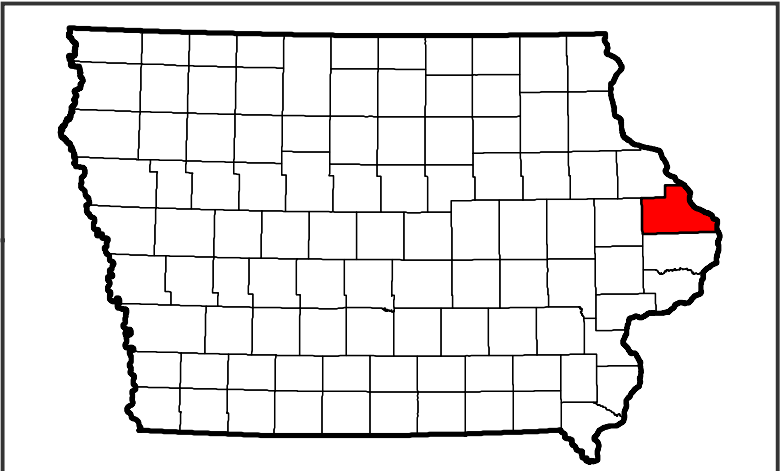

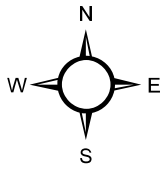

Jasper County

Newton, Iowa

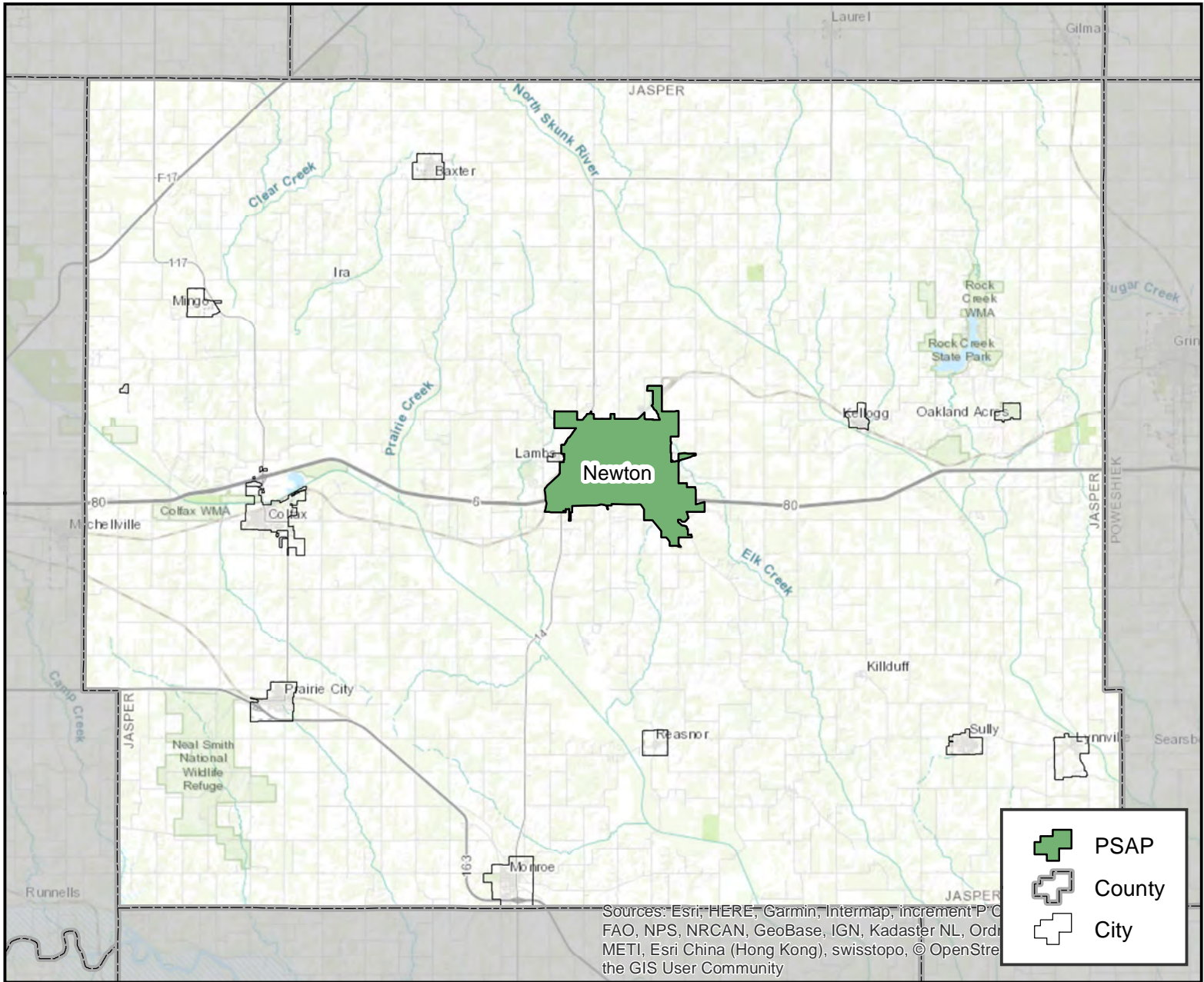

PSAP Information

Jasper County
FCC #: 1965
Phone #: 641-792-5912
2300 Law Center Drive Newton, IA 50208

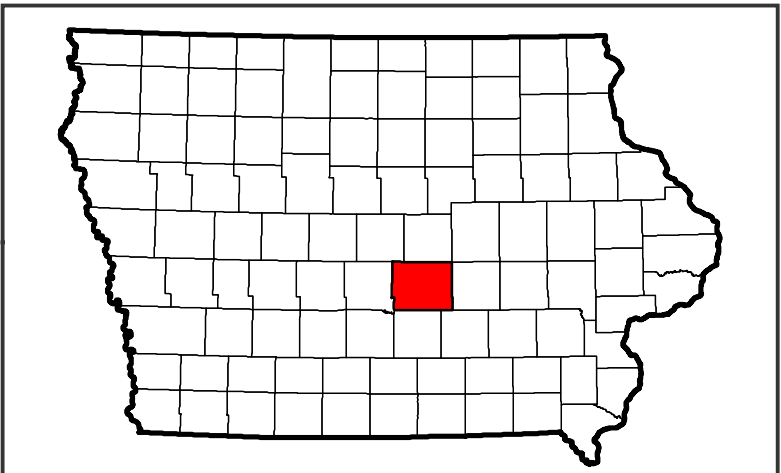

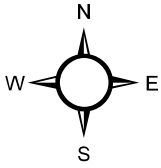

Jefferson County

Fairfield, Iowa

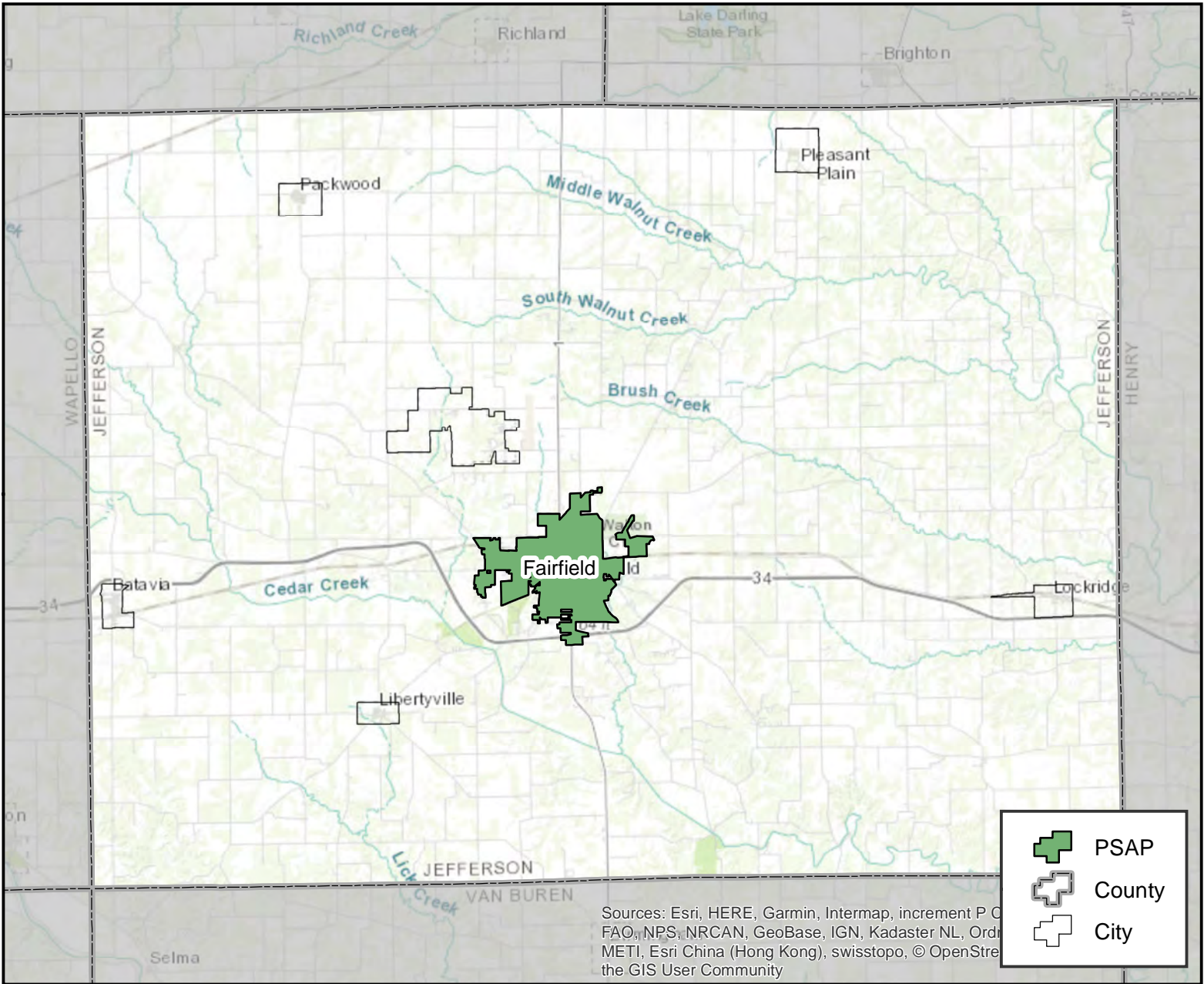

PSAP Information

Jefferson County Law Center
FCC #: 1966
Phone #: 641-472-4146
1200 West Grimes Fairfield, IA 52556

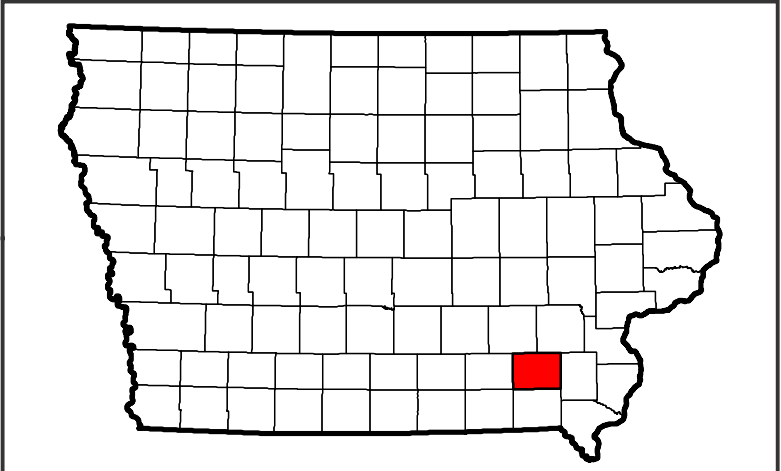

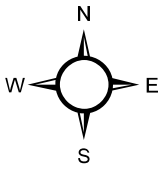

Johnson County

Iowa City, Iowa

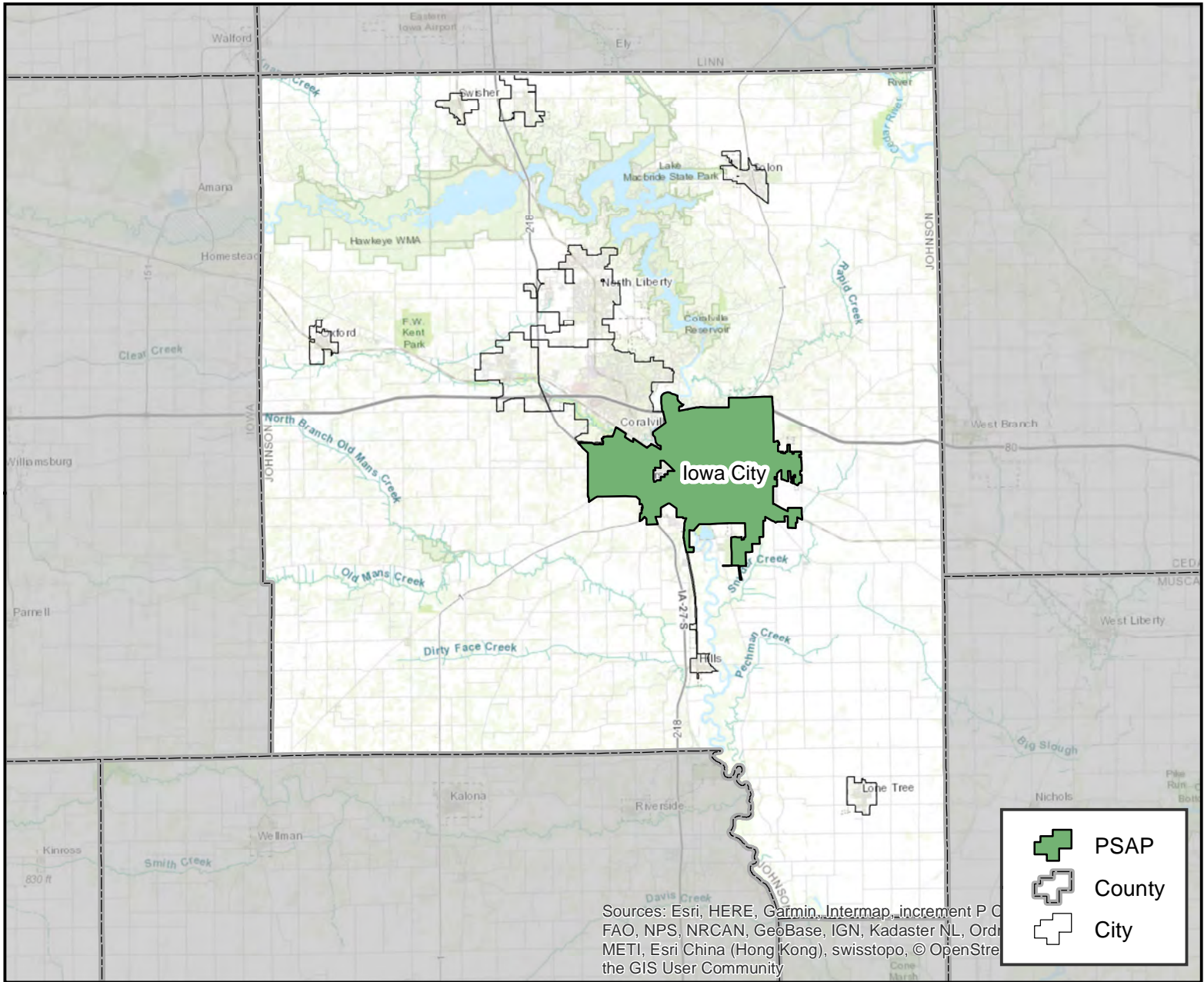

PSAP Information

Johnson County Joint Emergency Communications Services Association

FCC #: 1968

Phone #: 319-356-6800

4529 Melrose Ave. Iowa City, IA 52246

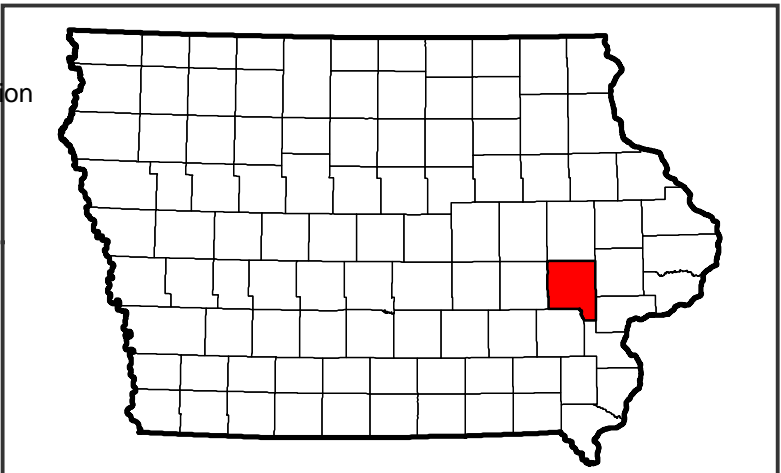

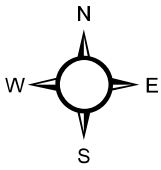

Jones County

Anamosa, Iowa

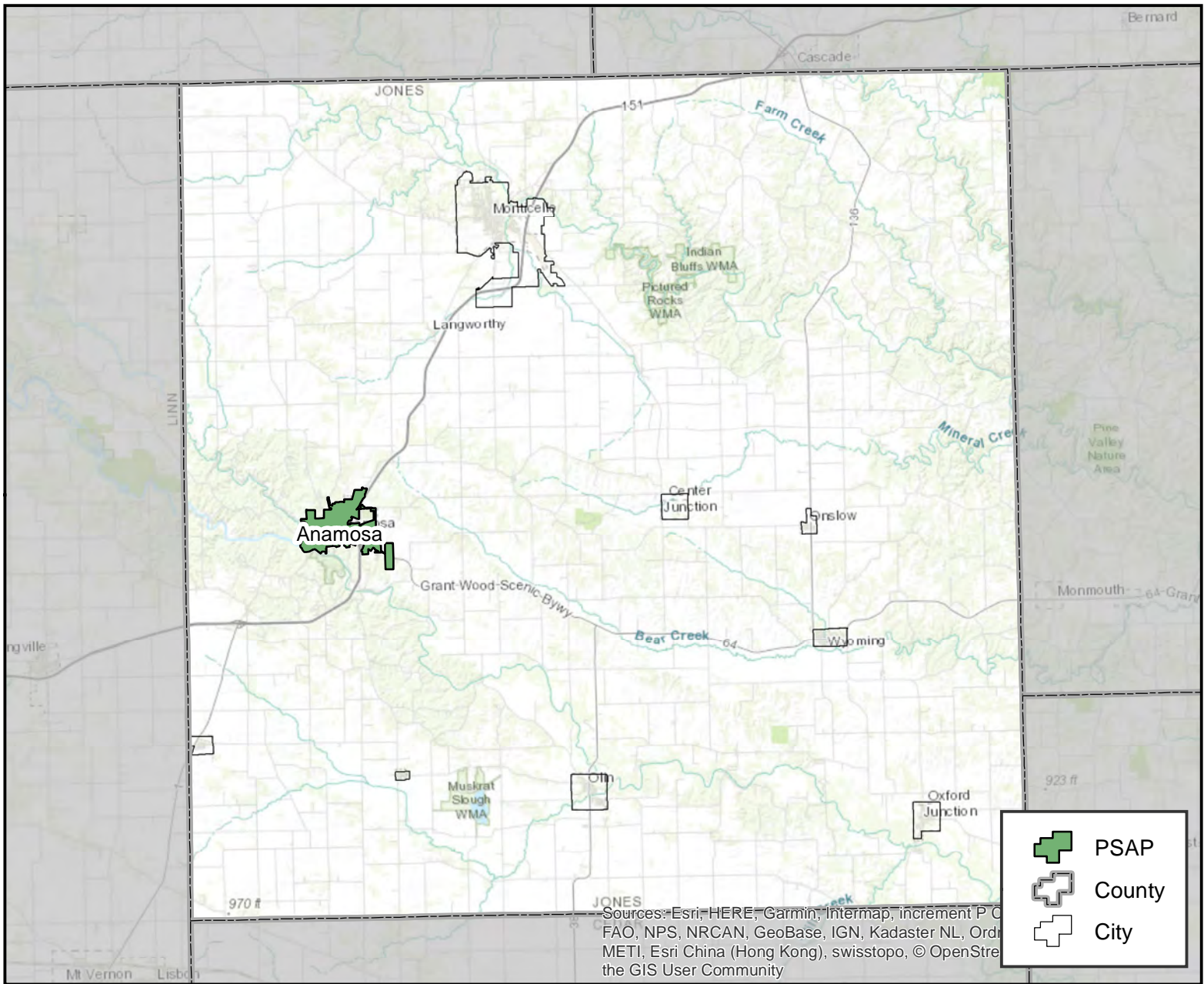

PSAP Information

Jones County Sheriff
FCC #: 1970
Phone #: 319-462-4371
500 West Main Street Anamosa, IA 52205

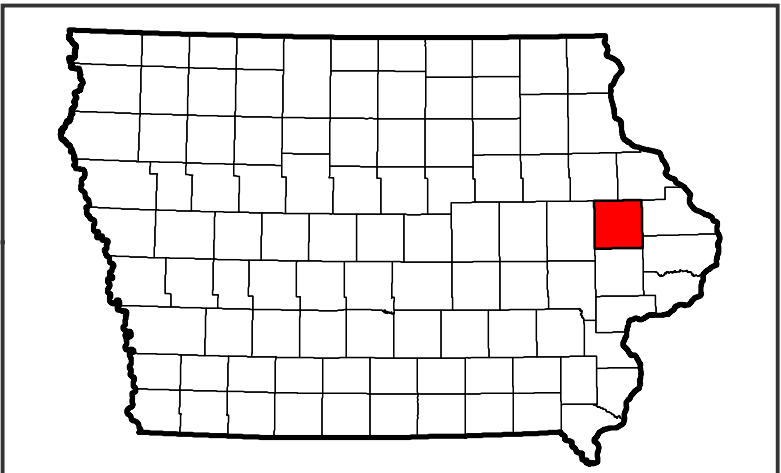

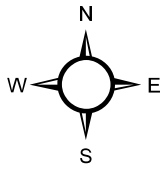

Keokuk County

Sigourney, Iowa

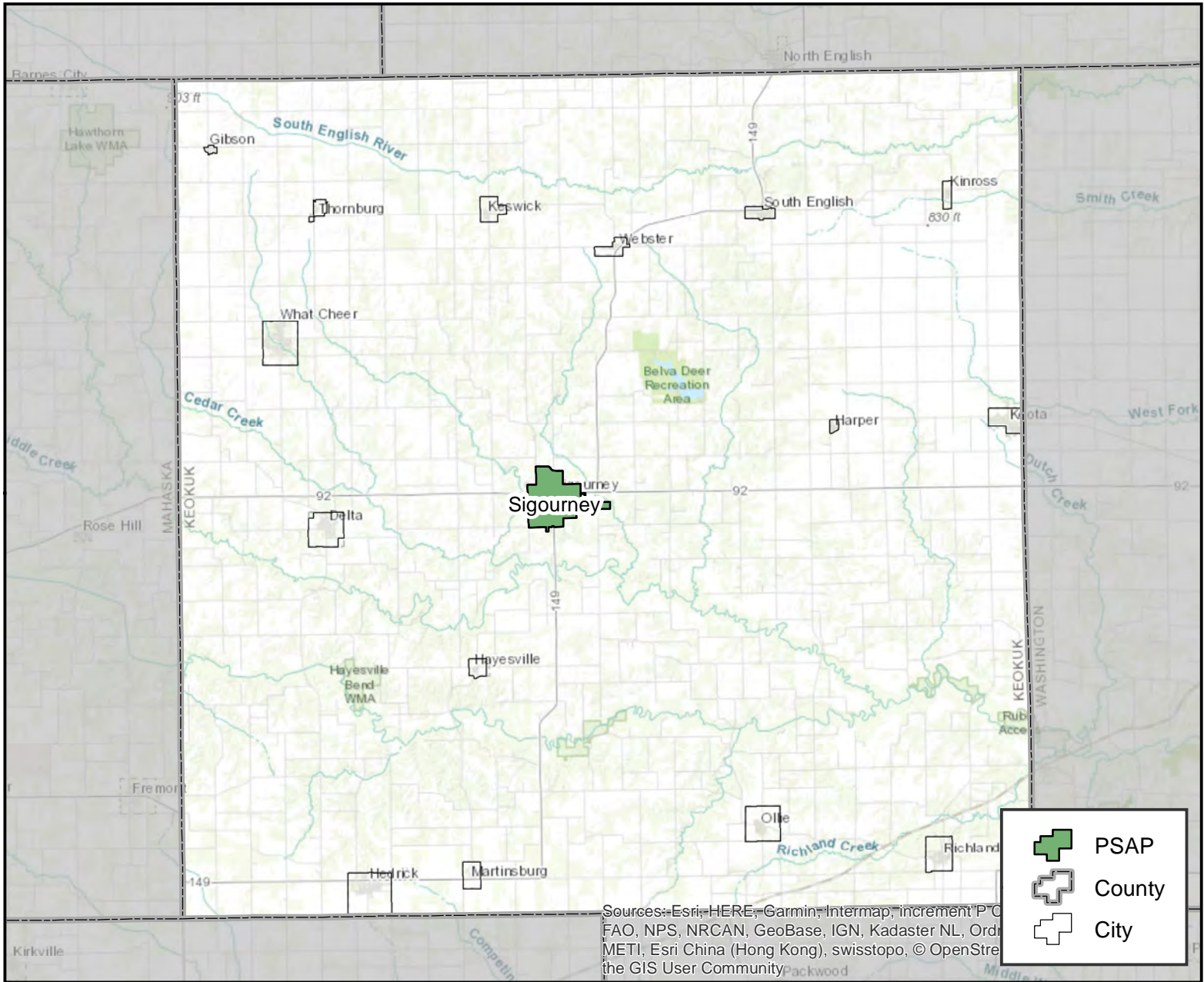

PSAP Information

Keokuk County Sheriffs Office
FCC #: 1971
Phone #: 641-622-2755
204 S Stone Street Sigourney, IA 52591

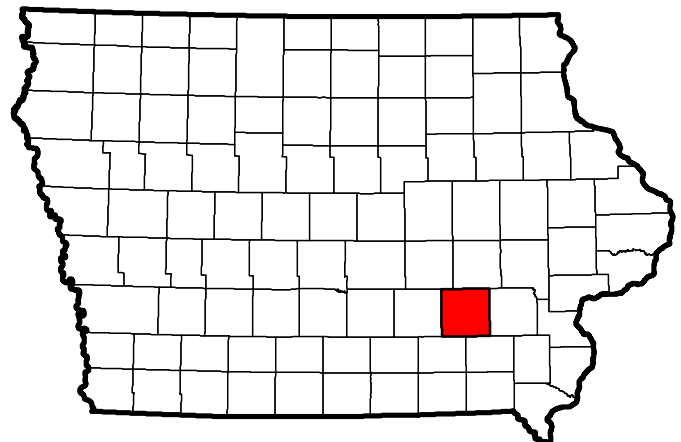

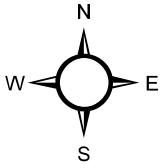

Kossuth County

Algona, Iowa

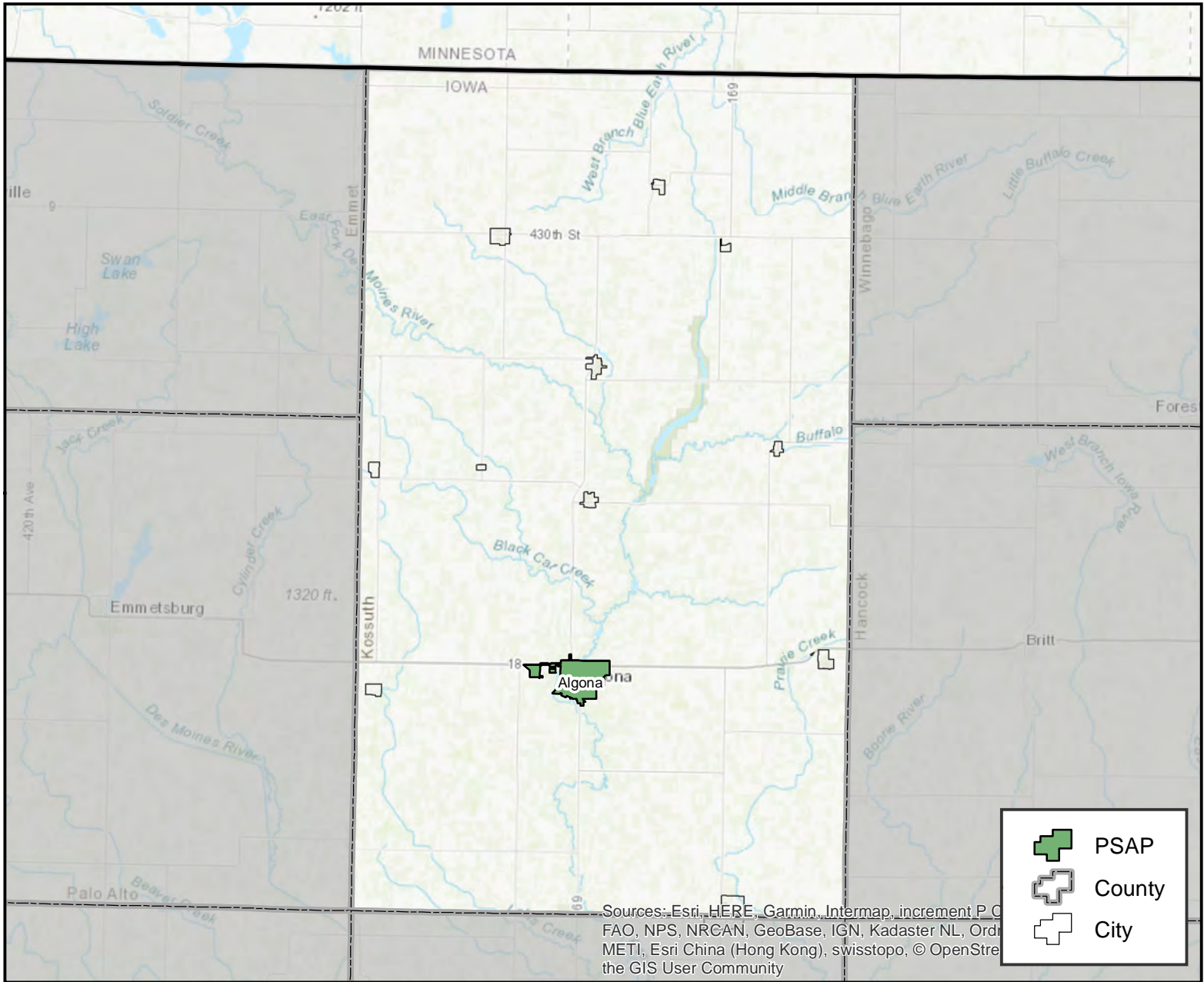

PSAP Information

Algona Police Dept
FCC #: 1892
Phone #: 515-295-3515
121 West State Street Algona, IA 50511

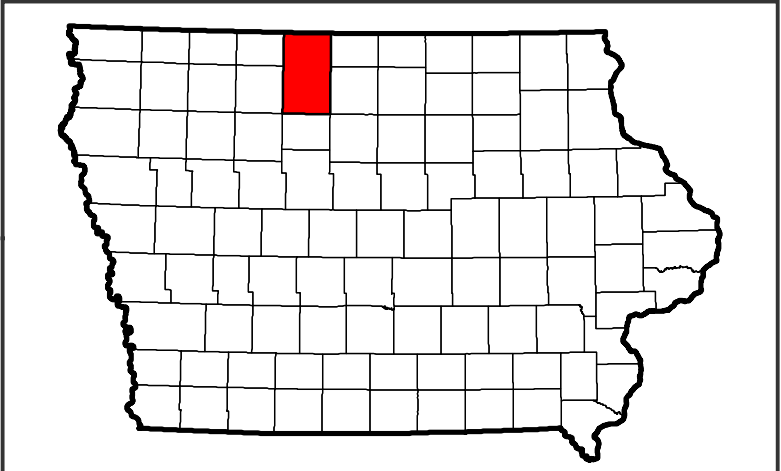

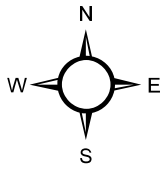

Lee County

Montrose, Iowa

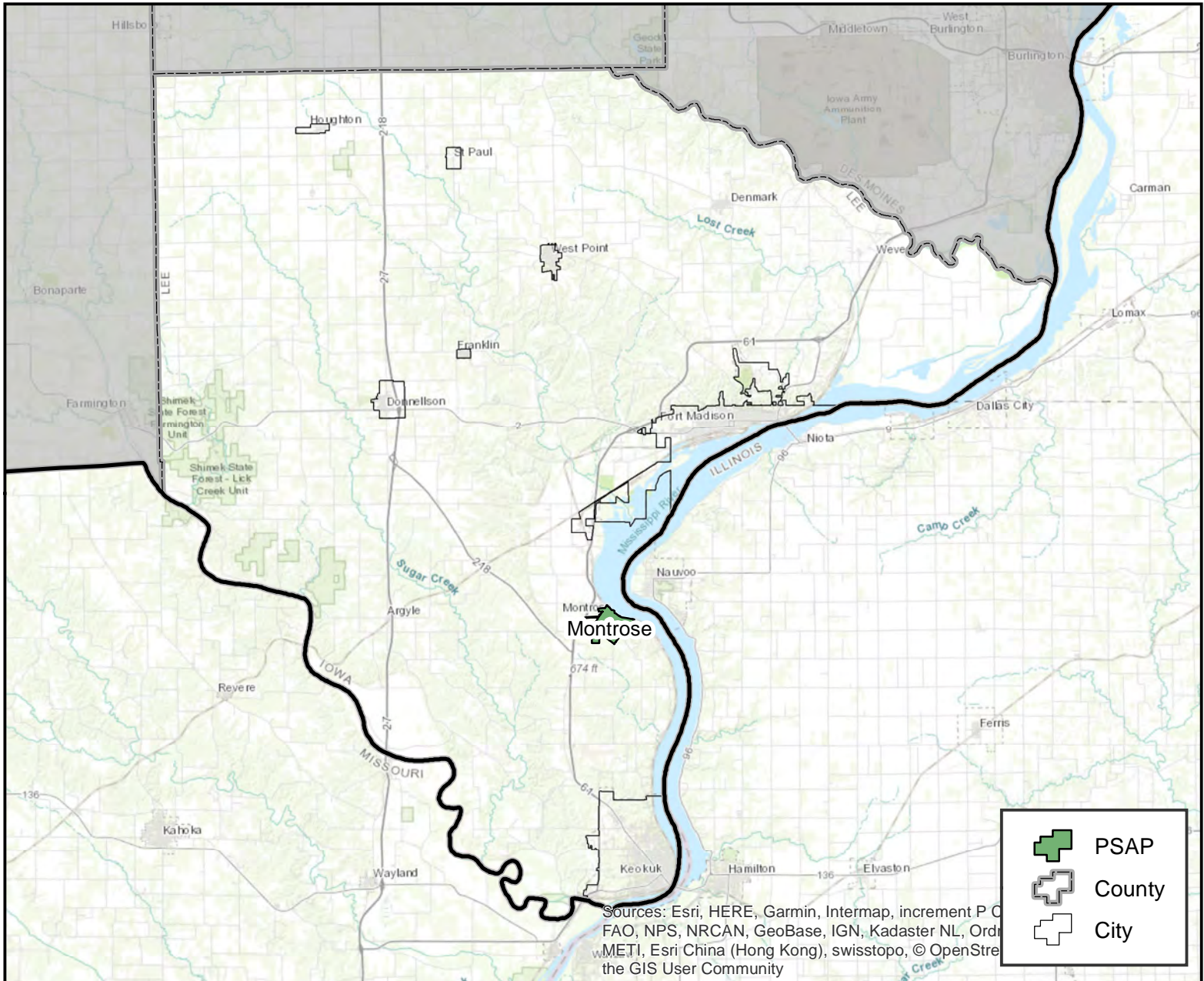

PSAP Information

Lee County PSAP (LeeComm)
FCC #: 1974
Phone #: 319-372-1310
2530 255th Street Montrose, IA 52639

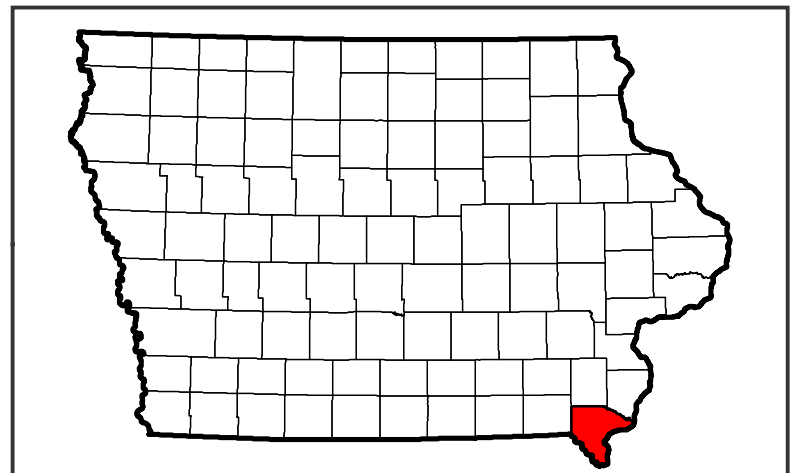

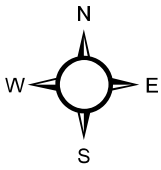

Linn County

Cedar Rapids, Iowa

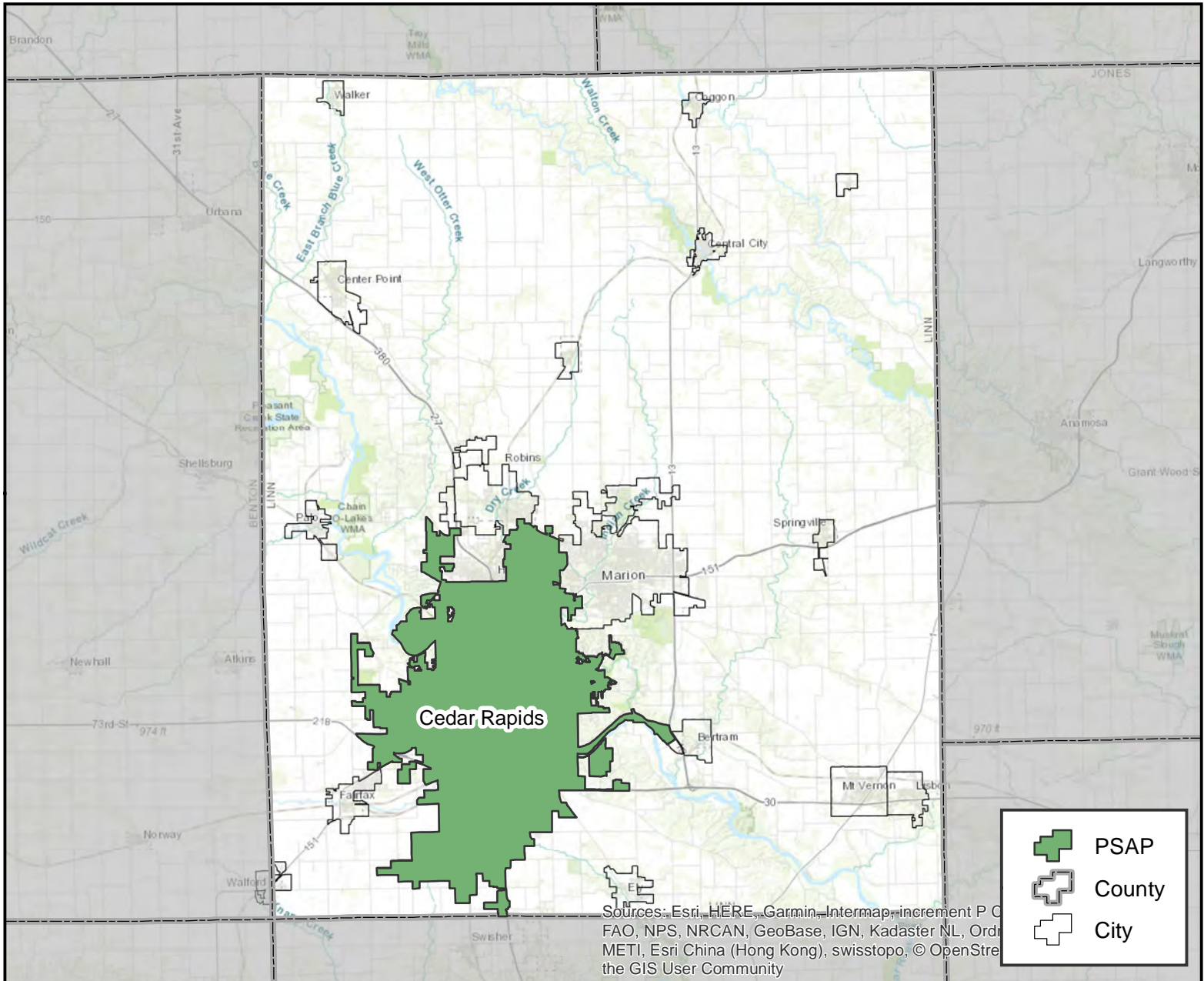

PSAP Information

Cedar Rapids Joint Communications Agency
FCC #: 1914
Phone #: 319-286-5491
505 1st St SW Cedar Rapids, IA 52404

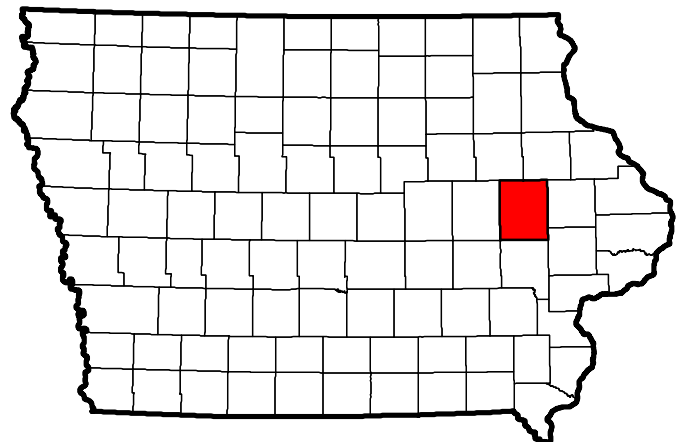

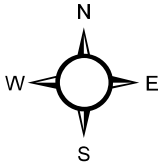

Linn County

Cedar Rapids, Iowa

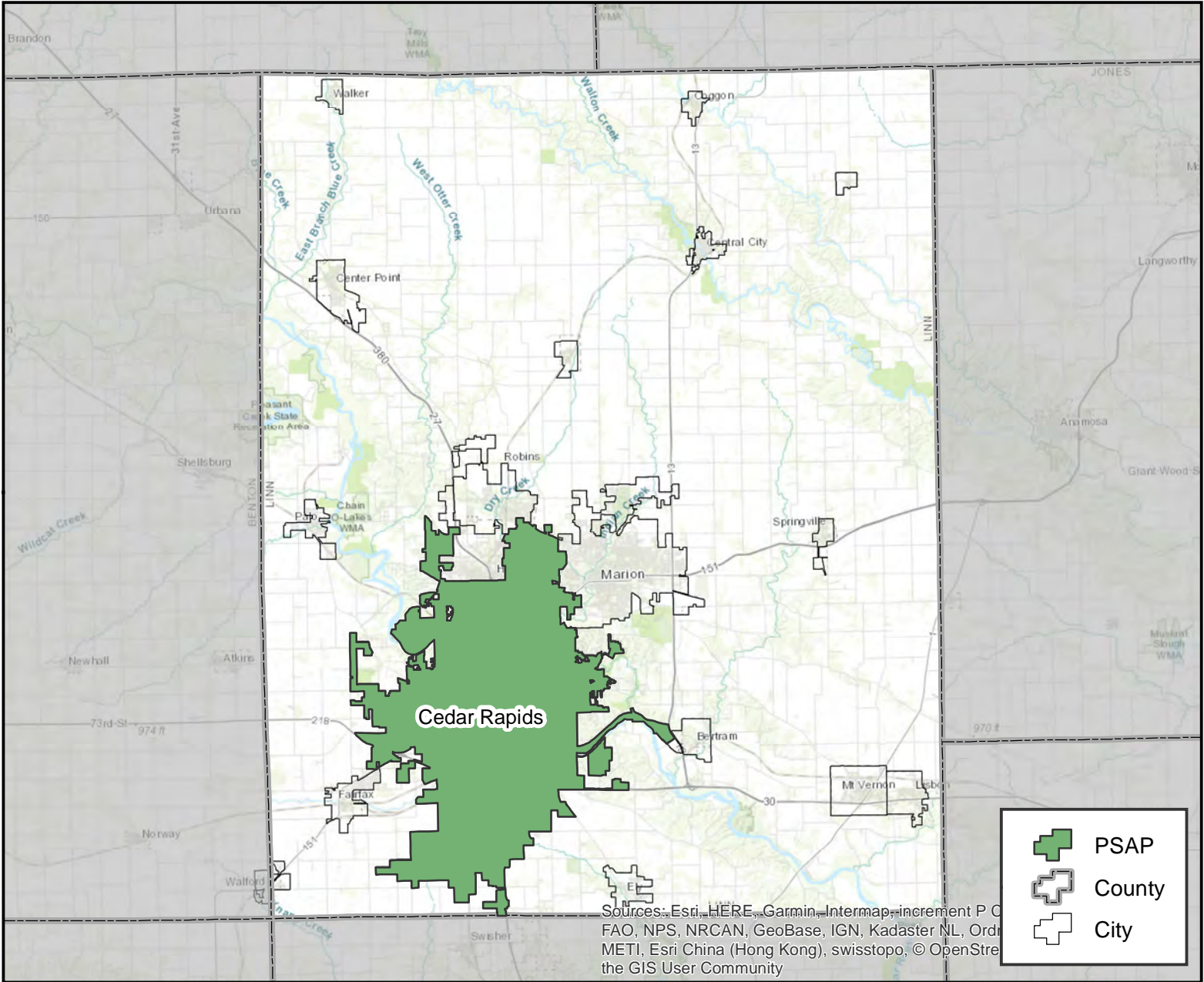

PSAP Information

Linn County Sheriff's Office
FCC #: 1975
Phone #: 319-398-3911
310 2nd Ave SW Cedar Rapids, IA 52404

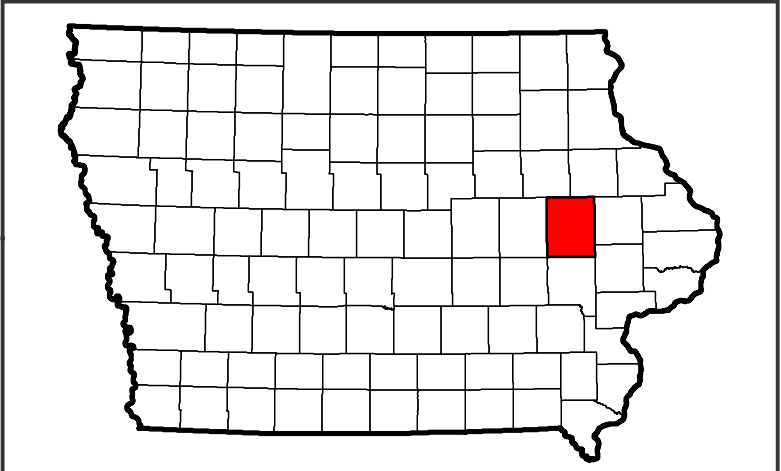

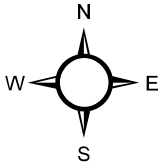

Linn County

Cedar Rapids, Iowa

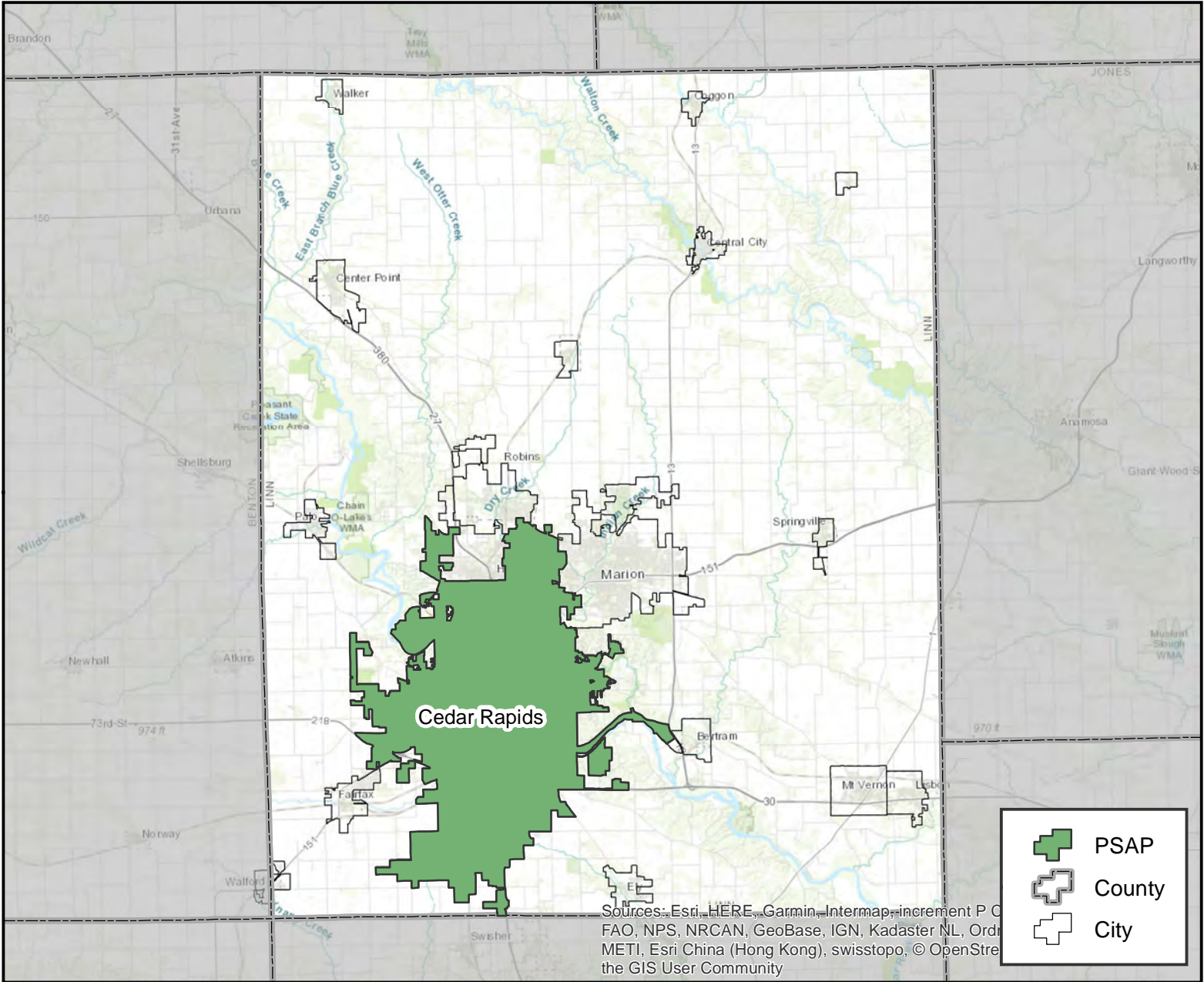

PSAP Information

Cedar Rapids Comm Center
FCC #: 8546
Phone #: 319-396-4414
5400 16th Avenue SW Cedar Rapids, IA 52404

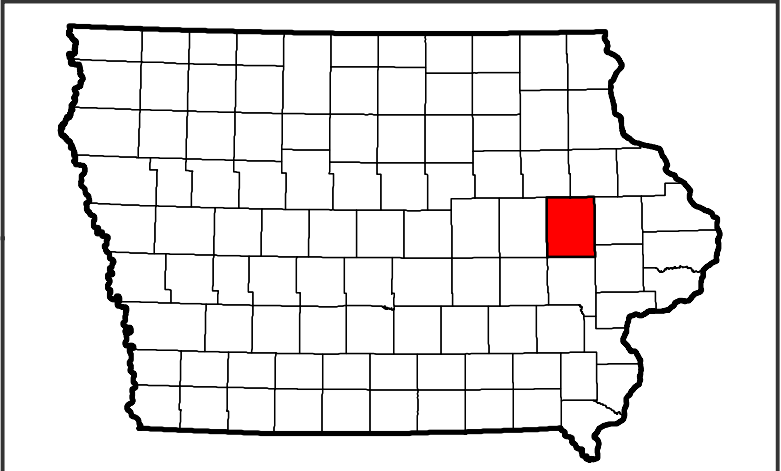

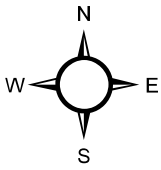

Linn County

Marion, Iowa

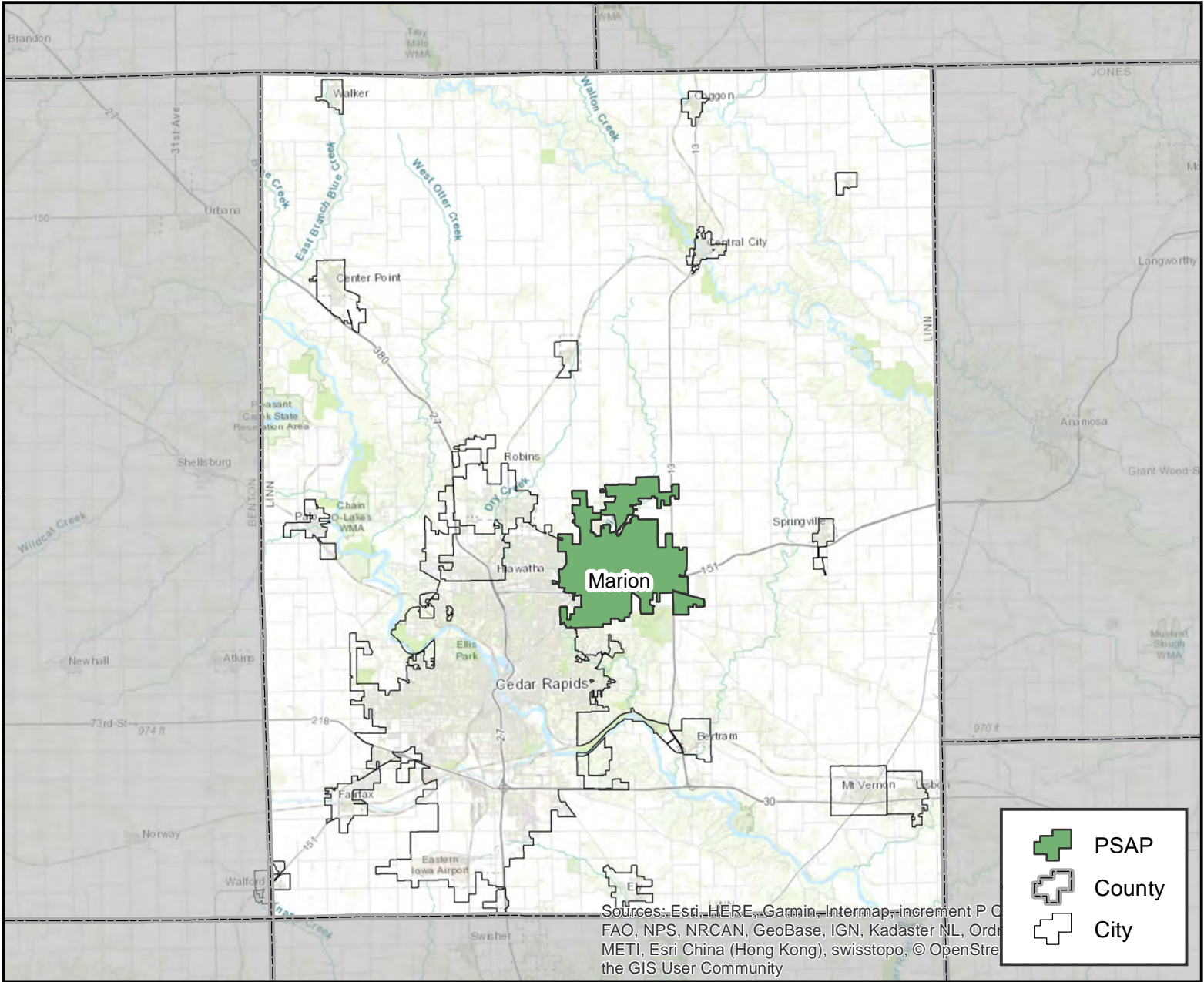

PSAP Information

Marion Police Department
FCC #: 1984
Phone #: 319-377-1511
6315 Hwy 151 Marion, IA 52302

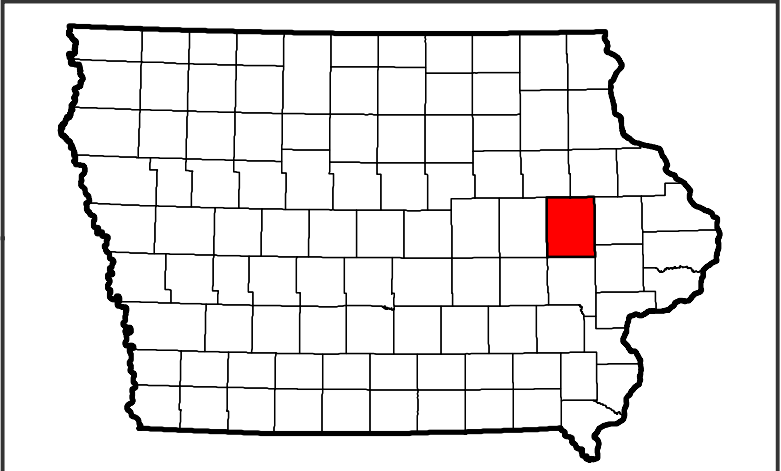

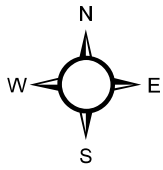

Louisa County

Wapello, Iowa

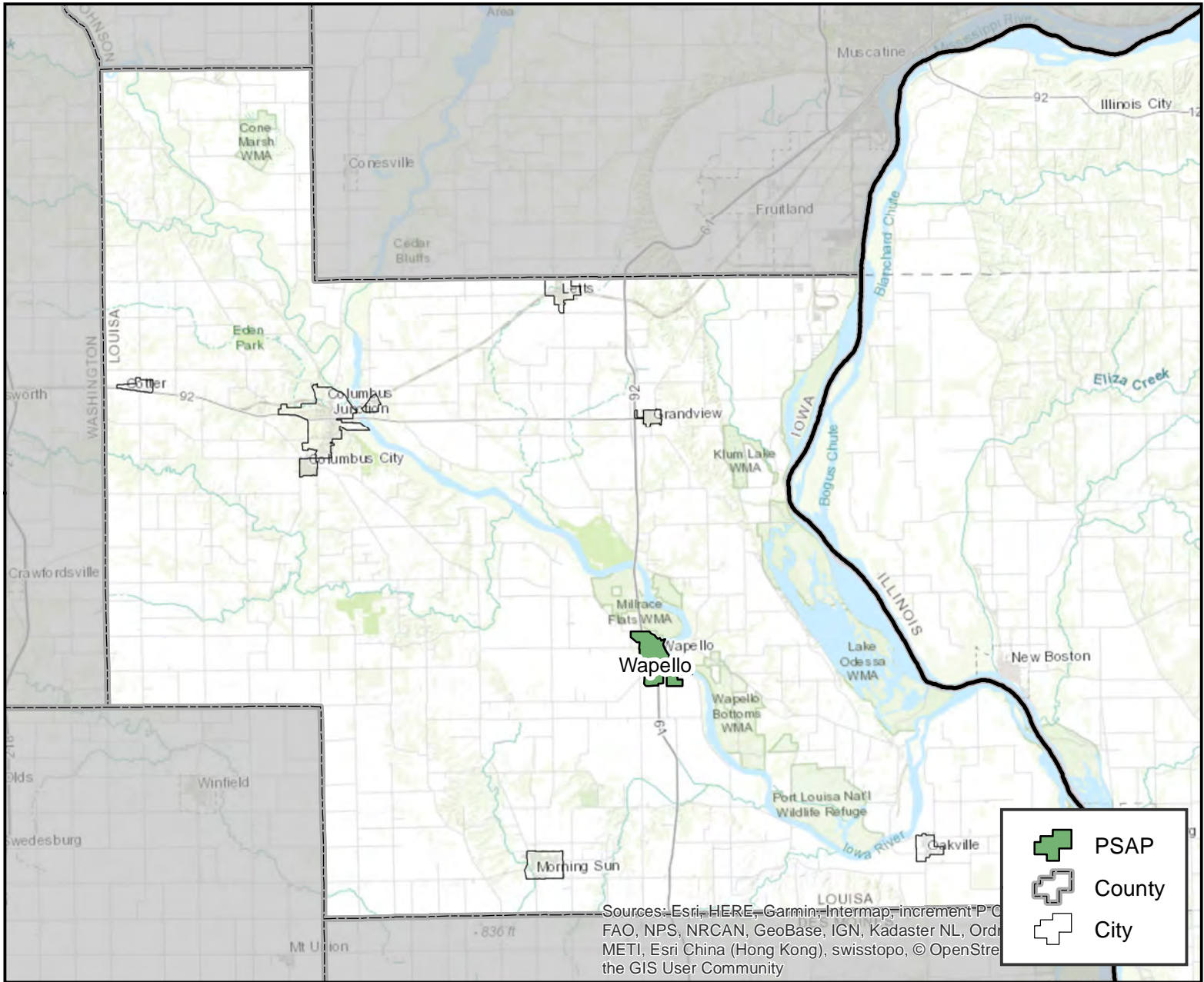

PSAP Information

LOUISA COUNTY SHERIFFS OFFICE

FCC #: 1976

Phone #: 319-523-4371

12635 COUNTY RD G56 STE 102 WAPELLO, IA 52653

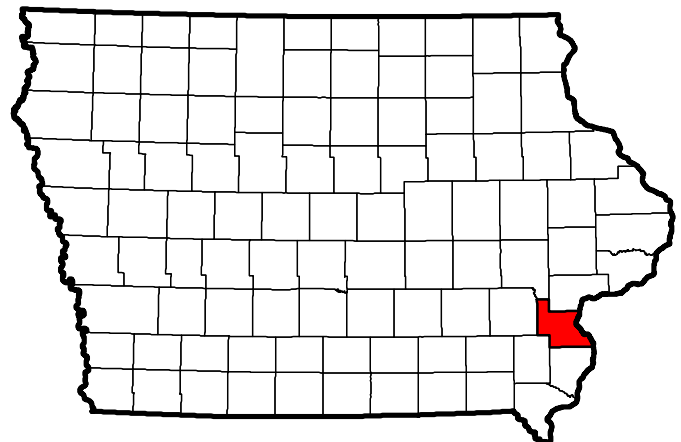

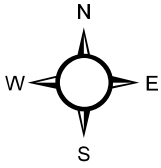

Lucas County

Chariton, Iowa

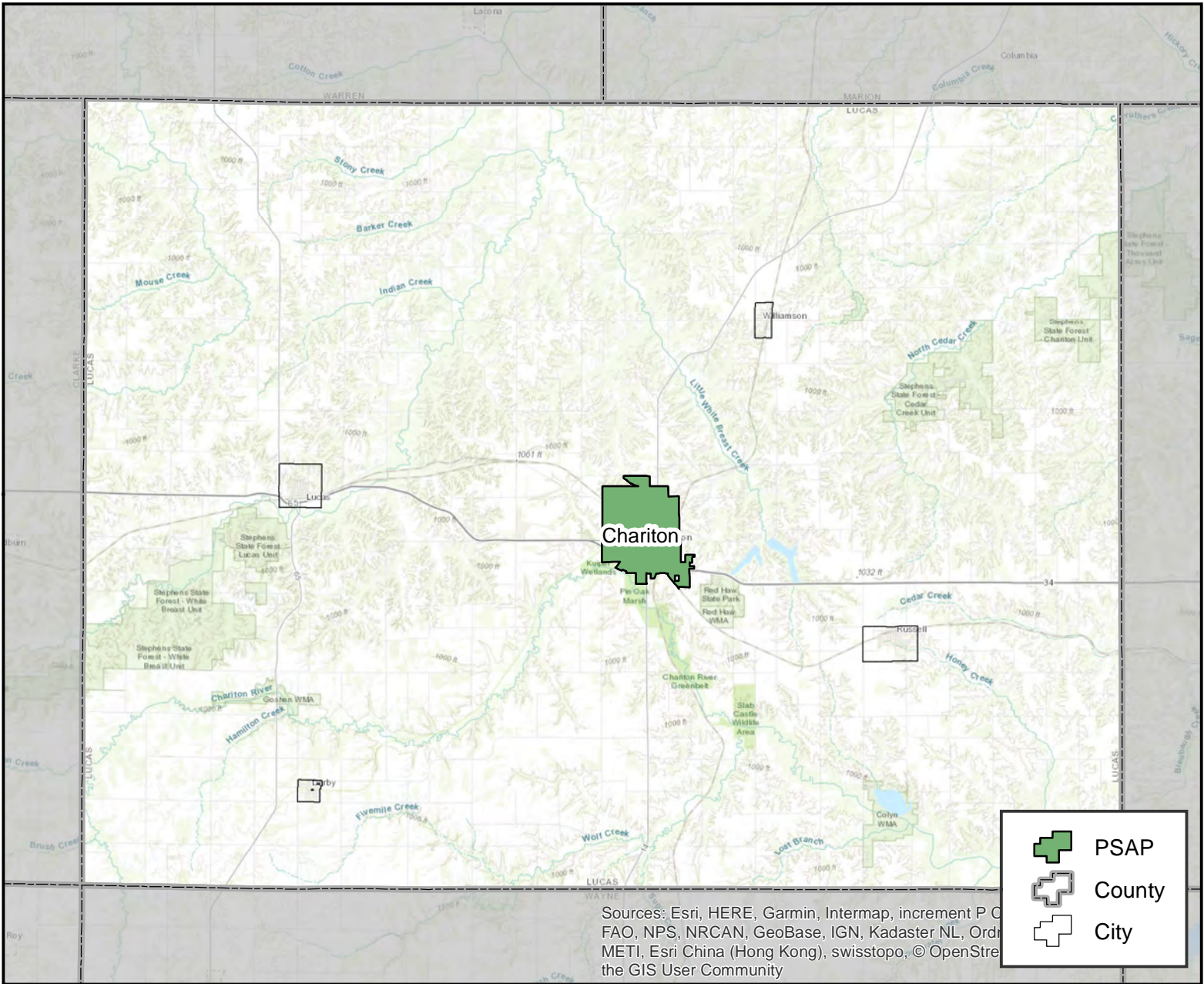

PSAP Information

Lucas County Sheriffs Office
FCC #: 1977
Phone #: 641-774-5083
48559 Hy-Vee RD Chariton, IA 50049

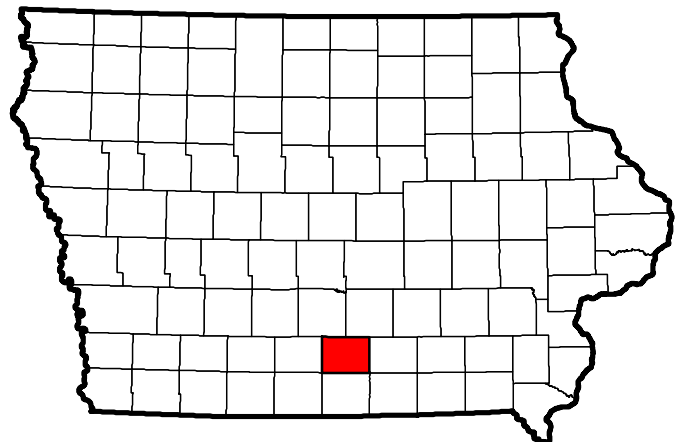

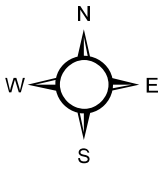

Lyon County

Rock Rapids, Iowa

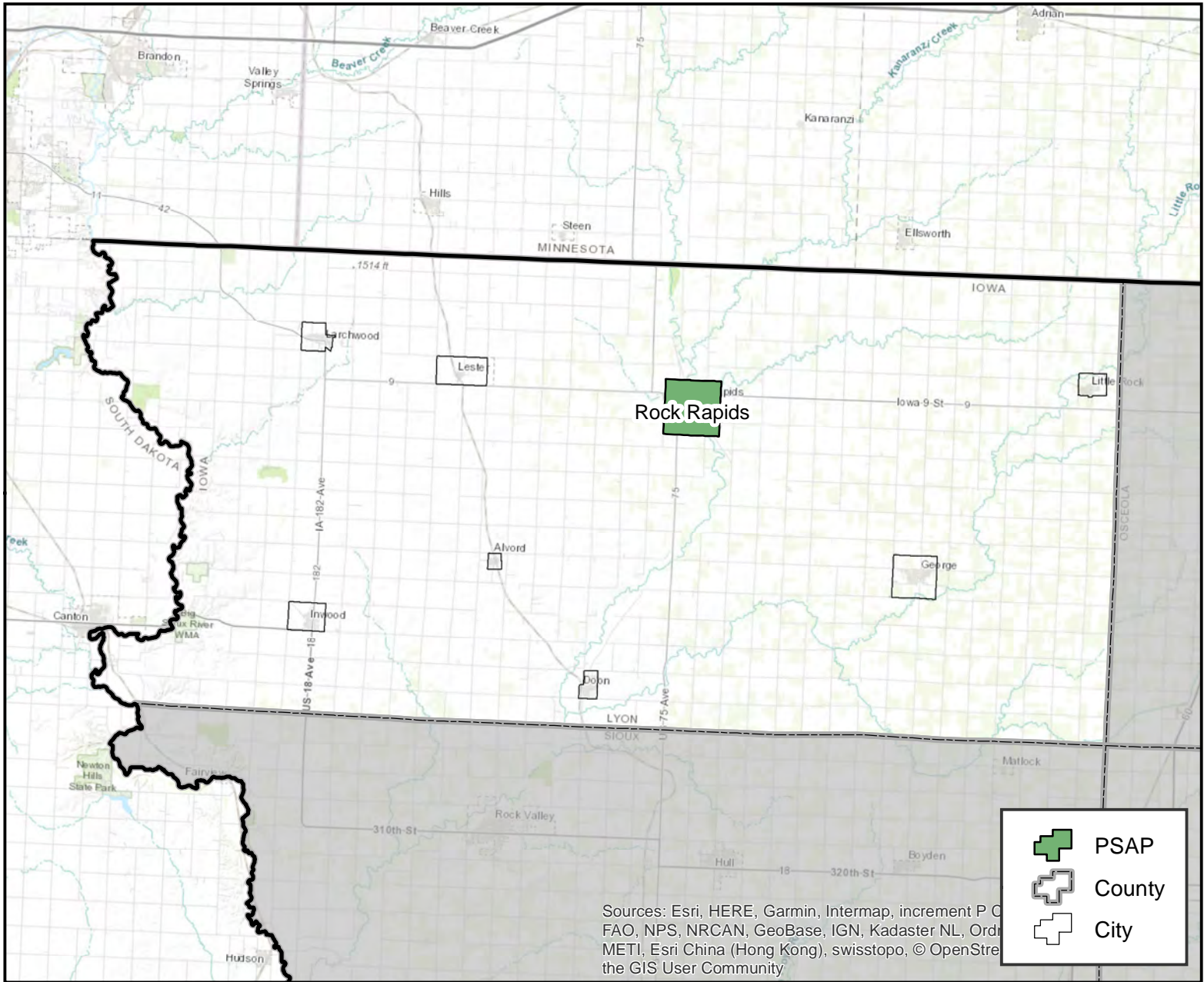

PSAP Information

Lyon County Sheriff
FCC #: 1978
Phone #: 712-472-8300
410 South Boone St Rock Rapids, IA 51246

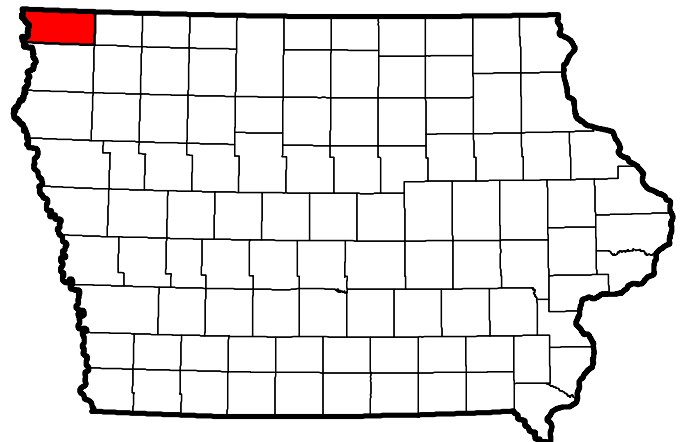

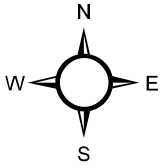

Madison County

Winterset, Iowa

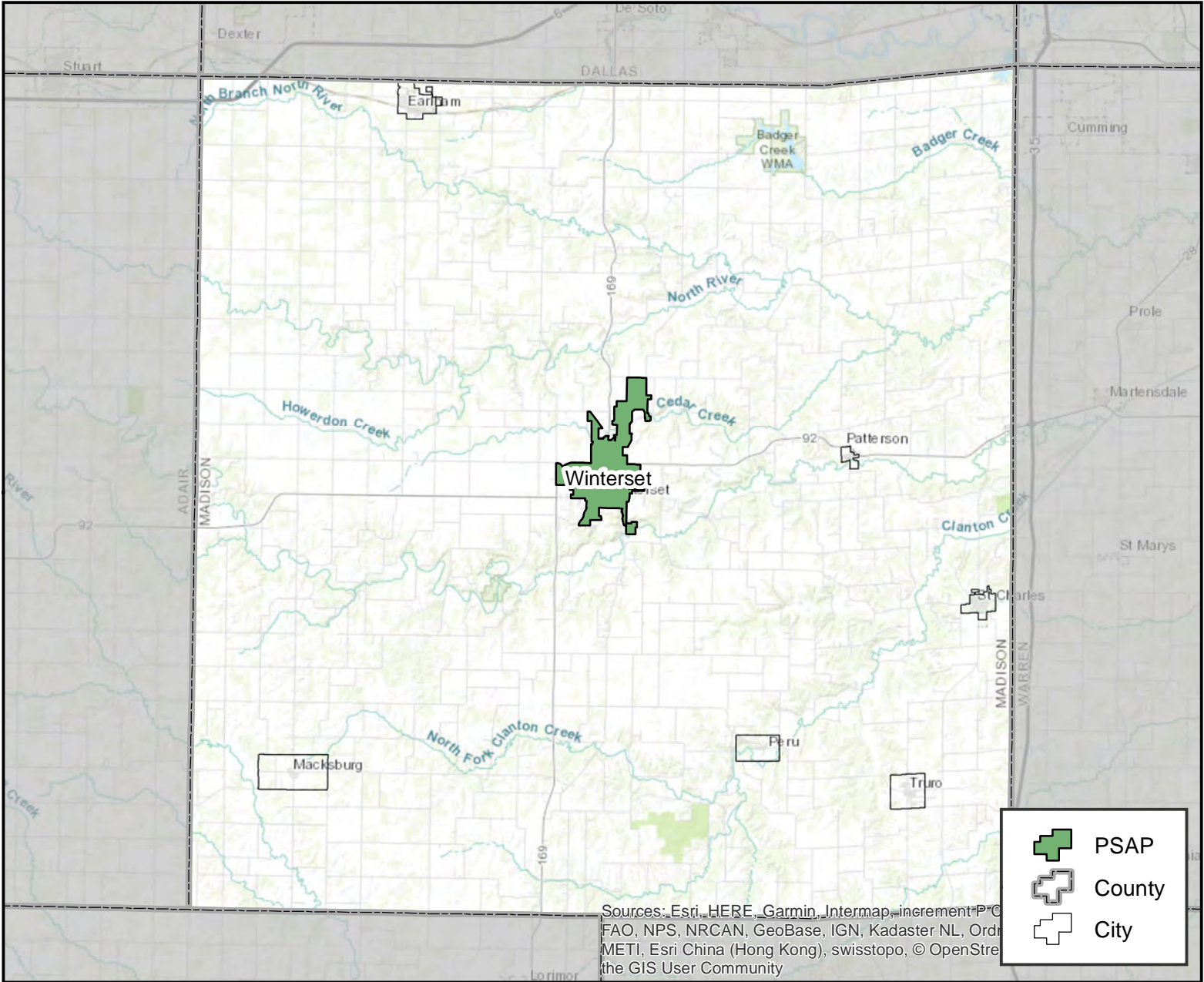

PSAP Information

Madison County Sheriff's Office
FCC #: 1979
Phone #: 515-462-3575
1012 N John Wayne Dr Winterset, IA 50273

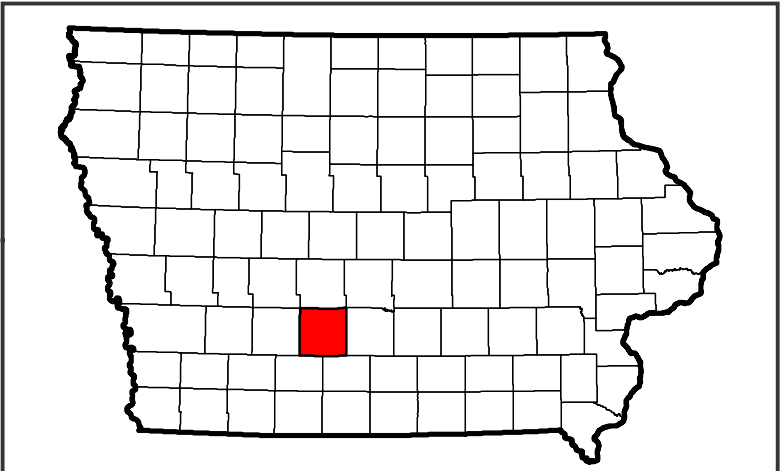

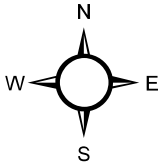

Mahaska County

Oskaloosa, Iowa

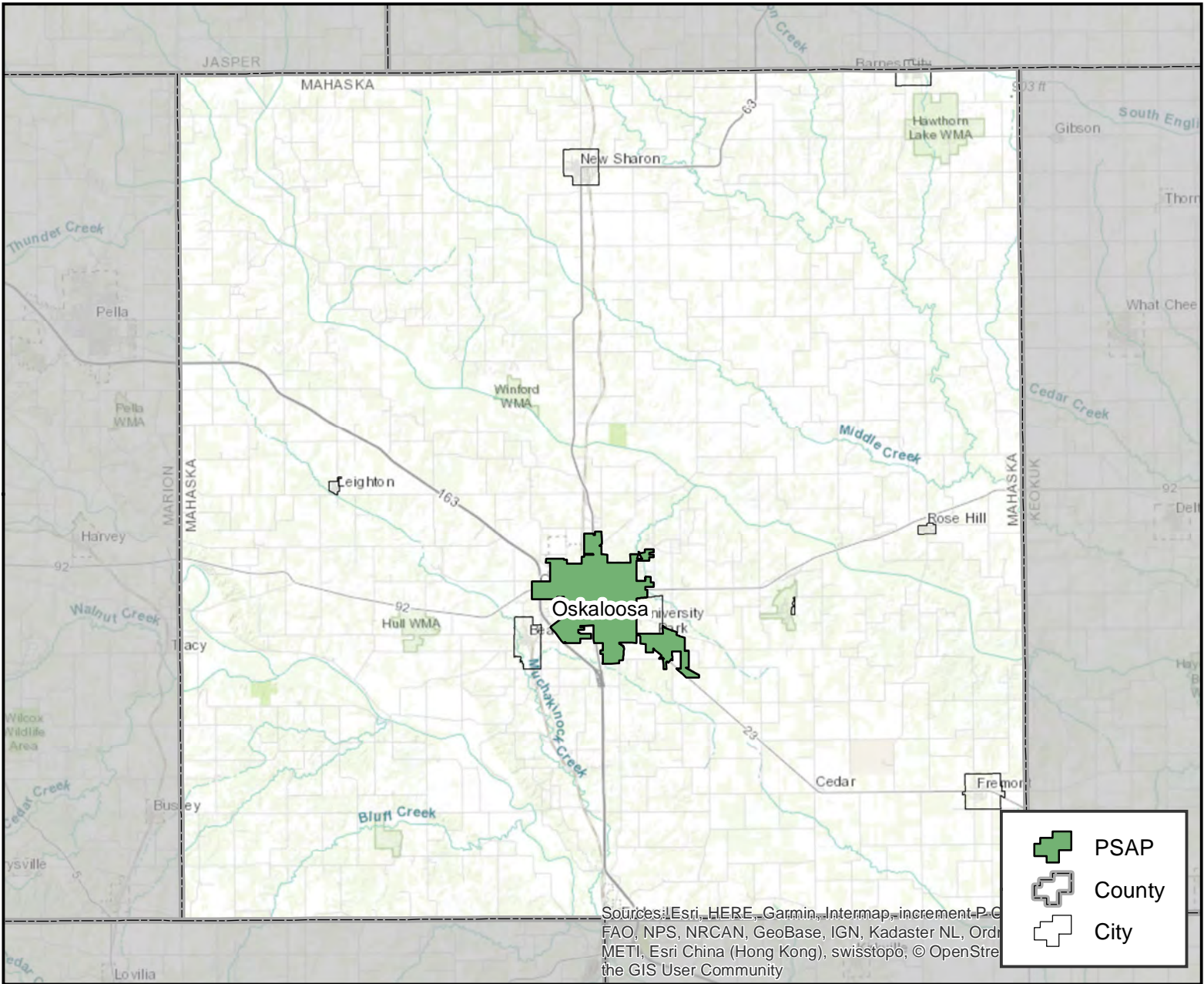

PSAP Information

Mahaska County 911 Center
FCC #: 1980
Phone #: 641-673-0347
214 High Ave East Oskaloosa, IA 52577

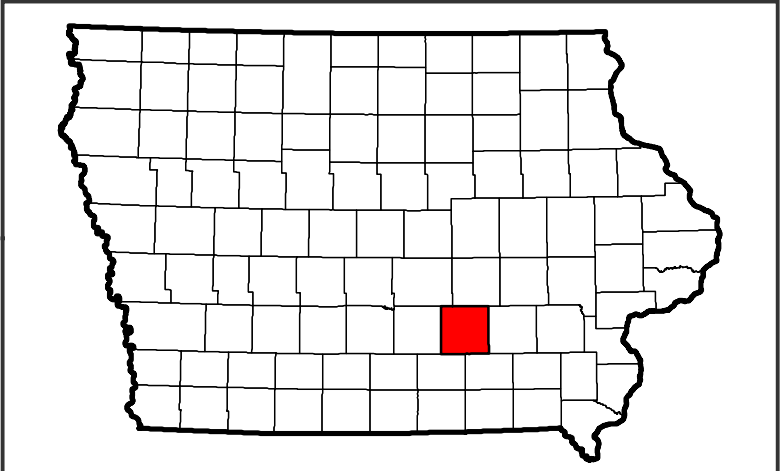

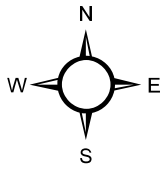

Marion County

Knoxville, Iowa

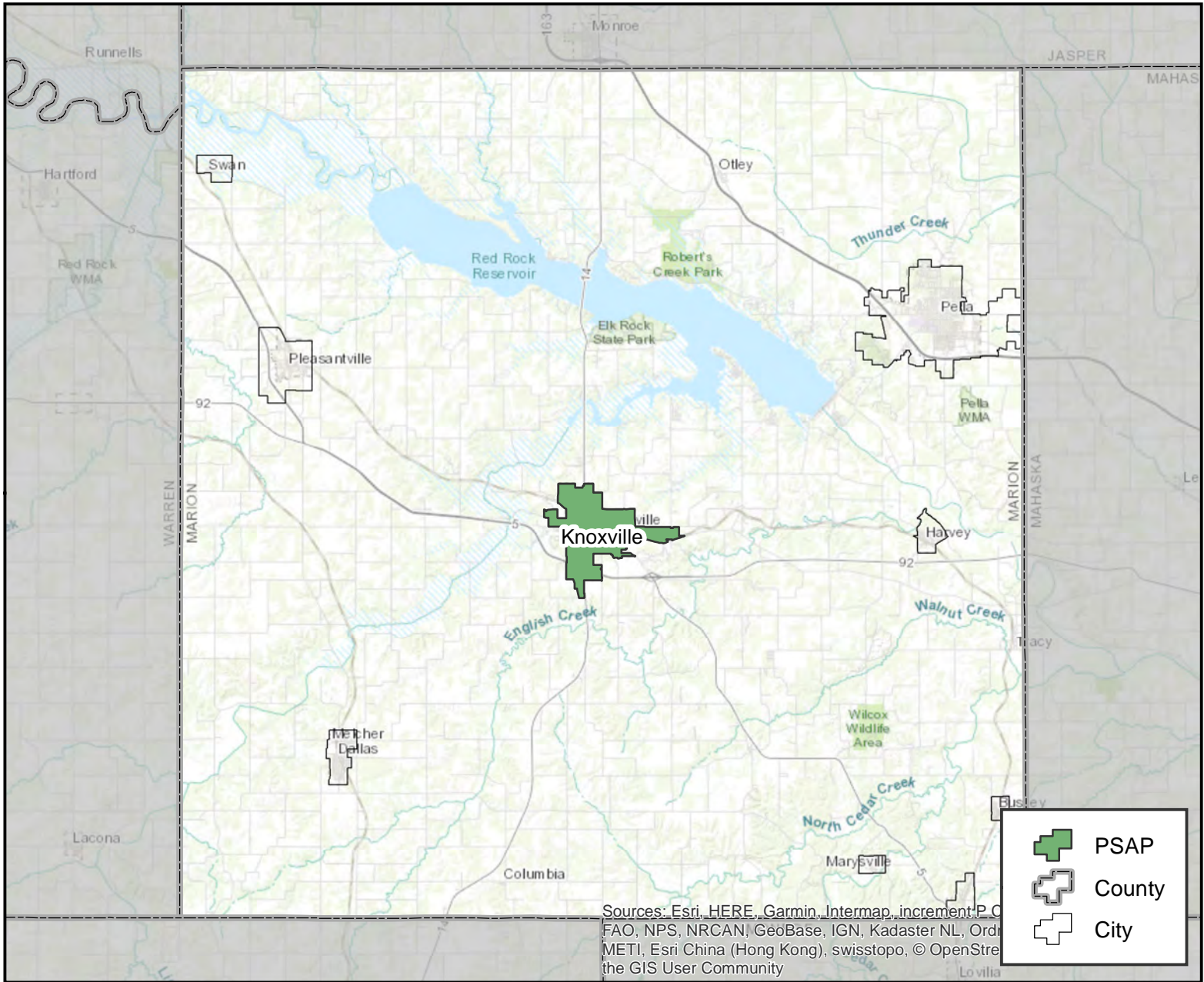

PSAP Information

Marion County Sheriff's Office
FCC #: 1983
Phone #: 641-828-2220
211 North Godfrey Lane Knoxville, IA 50138

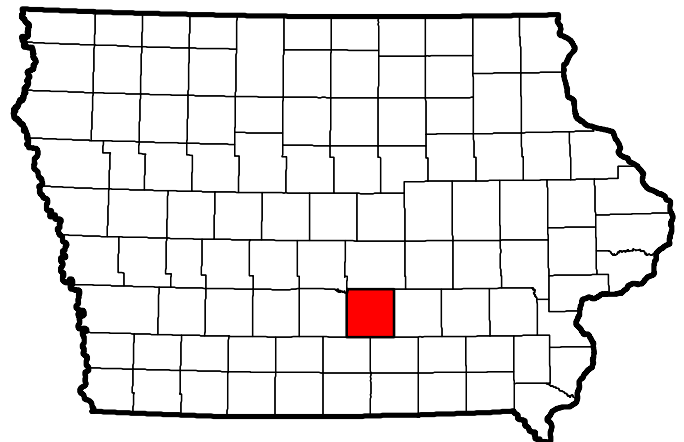

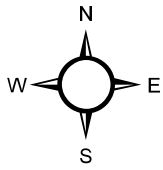

Marion County

Pella, Iowa

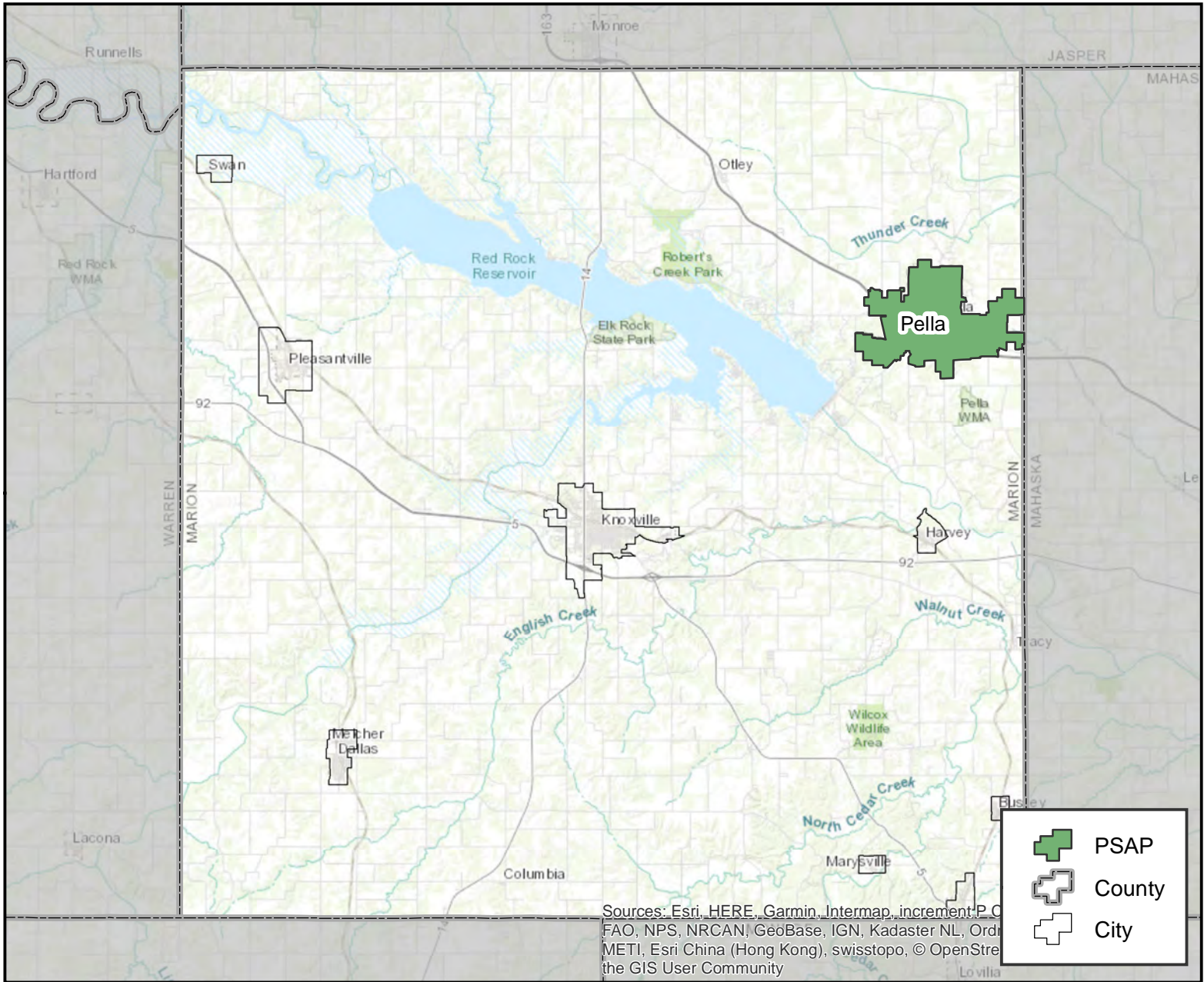

PSAP Information

Pella Police Department
FCC #: 2000
Phone #: 641-628-4921
614 Main St Pella, IA 50219

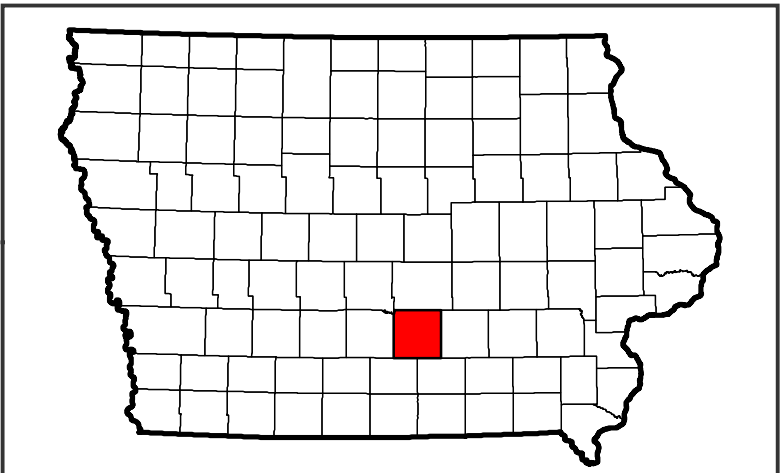

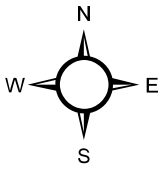

Marshall County

Marshalltown, Iowa

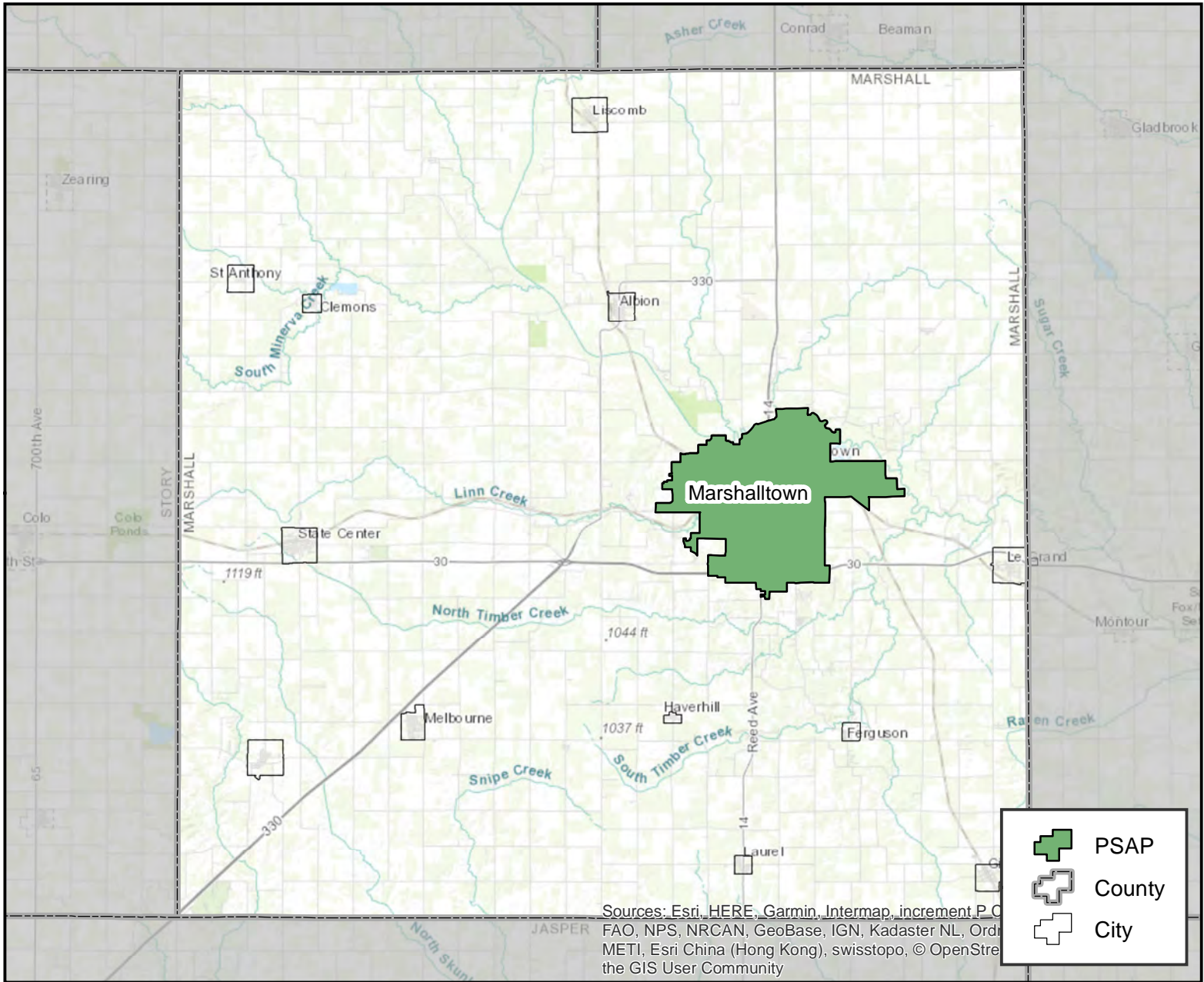

PSAP Information

Marshalltown Police Department
FCC #: 1985
Phone #: 641-754-5725
22 N Center St Marshalltown, IA 50158

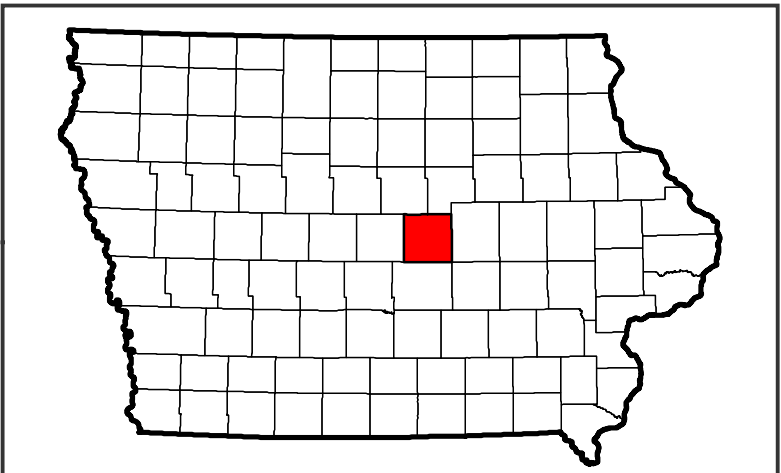

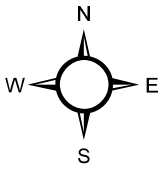

Mills County

Glenwood, Iowa

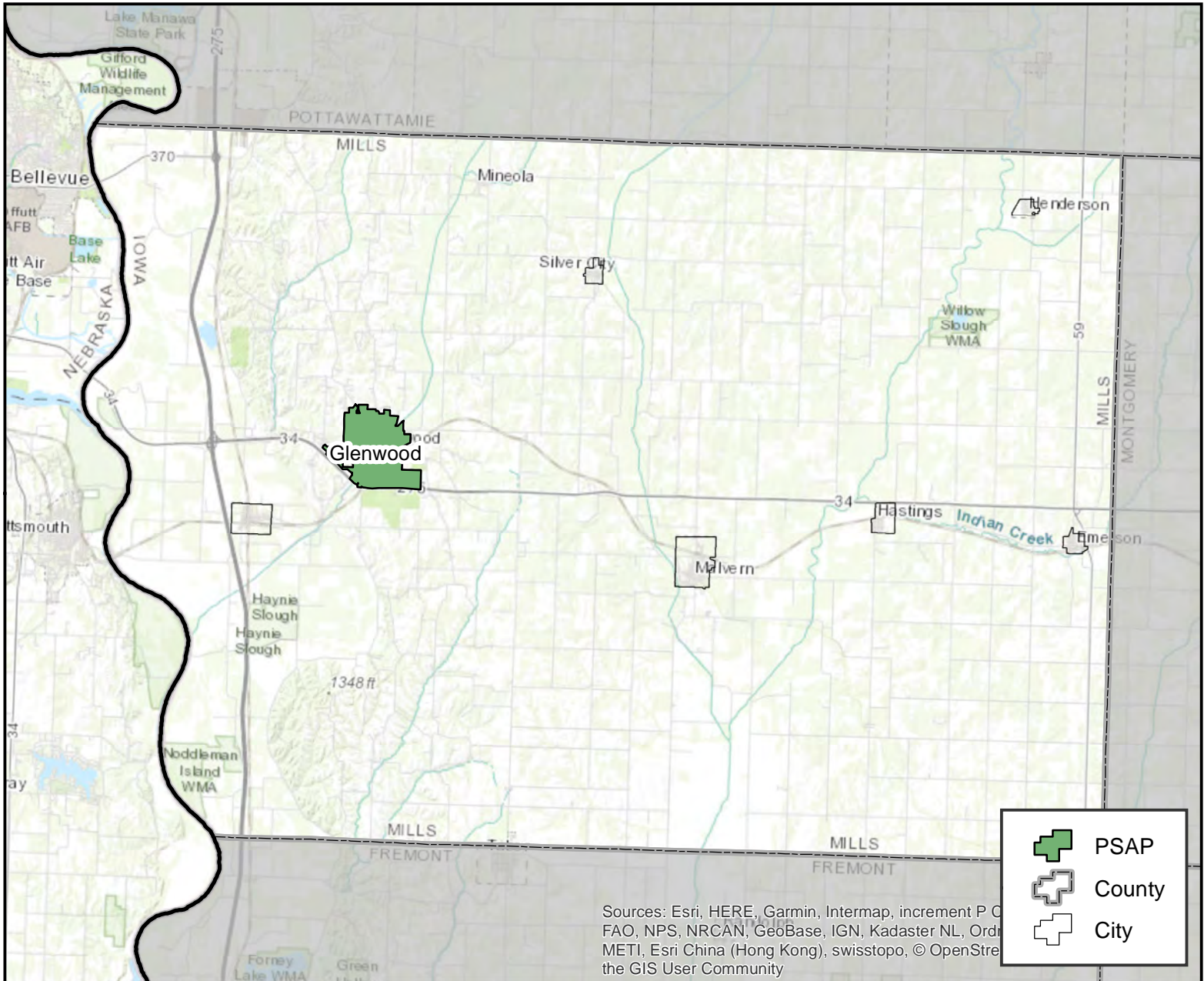

PSAP Information

Mills County Communications Center
FCC #: 1987
Phone #: 712-527-4871
418 Sharp Street Glenwood, IA 51534

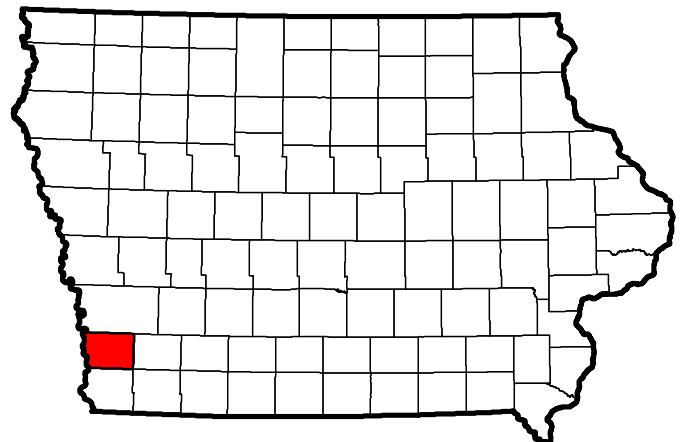

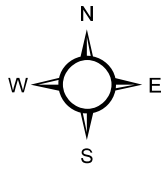

Mitchell County

Osage, Iowa

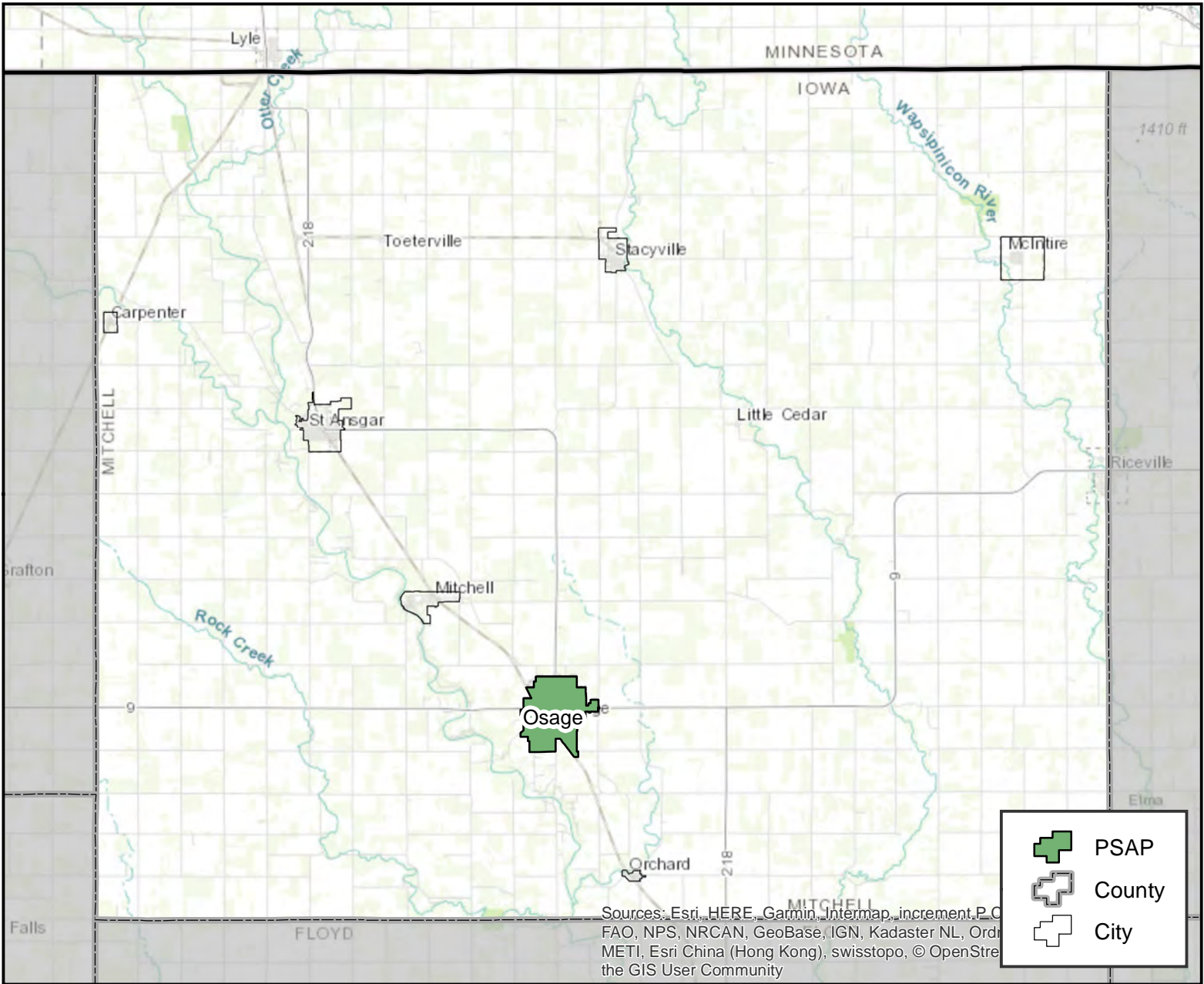

PSAP Information

Mitchell County Communications Center
FCC #: 1988
Phone #: 641-732-5832
211 S 6th St Osage, IA 50461

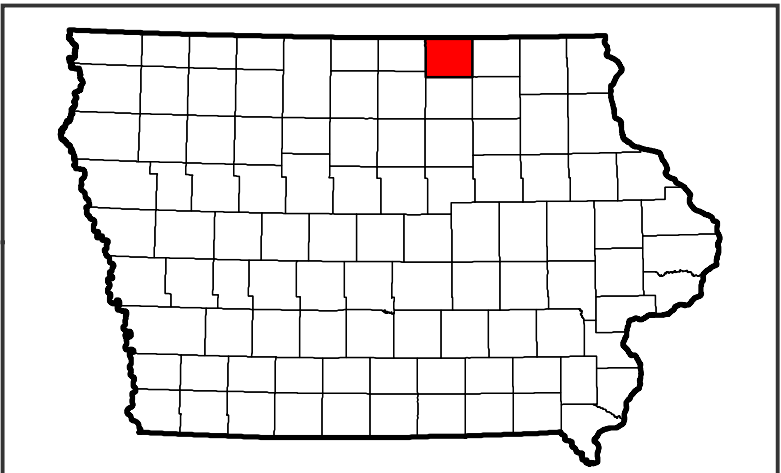

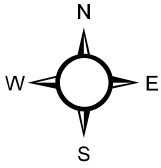

Monona County

Onawa, Iowa

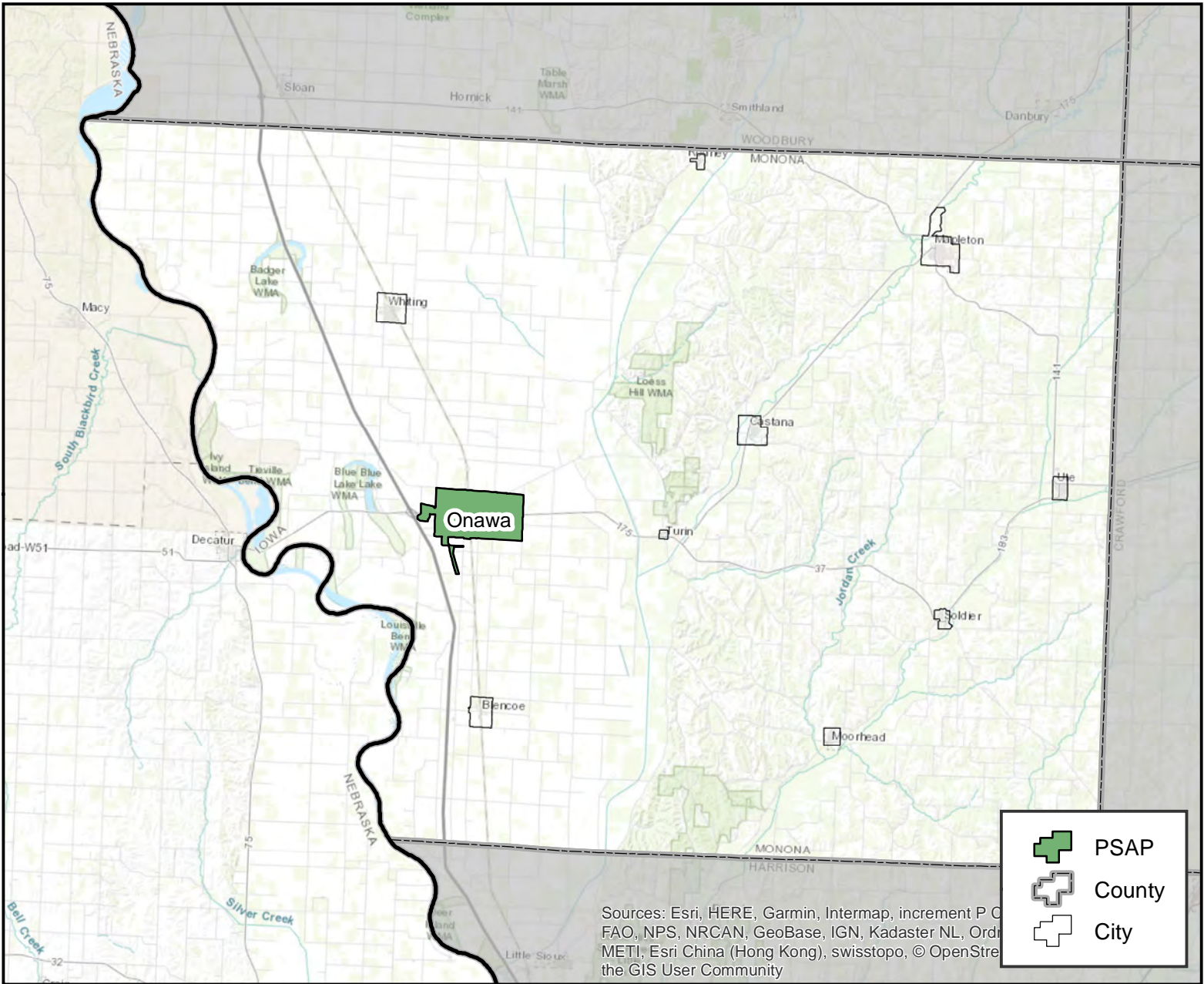

PSAP Information

Monona County Sheriff's Office
FCC #: 1989
Phone #: 712-433-1414
909 7TH STREET ONAWA, IA 51040

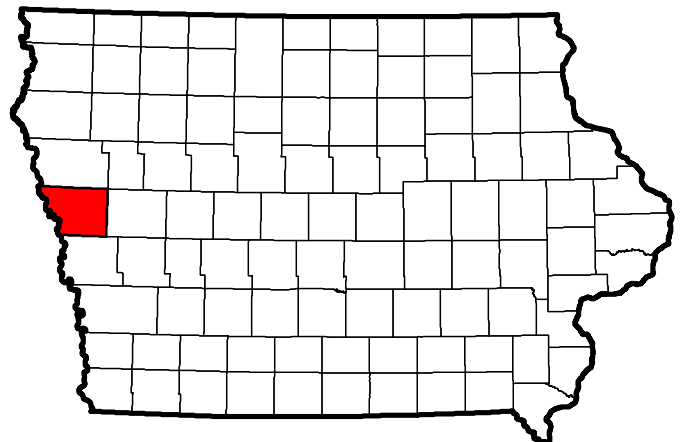

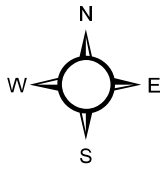

Monroe County

Albia, Iowa

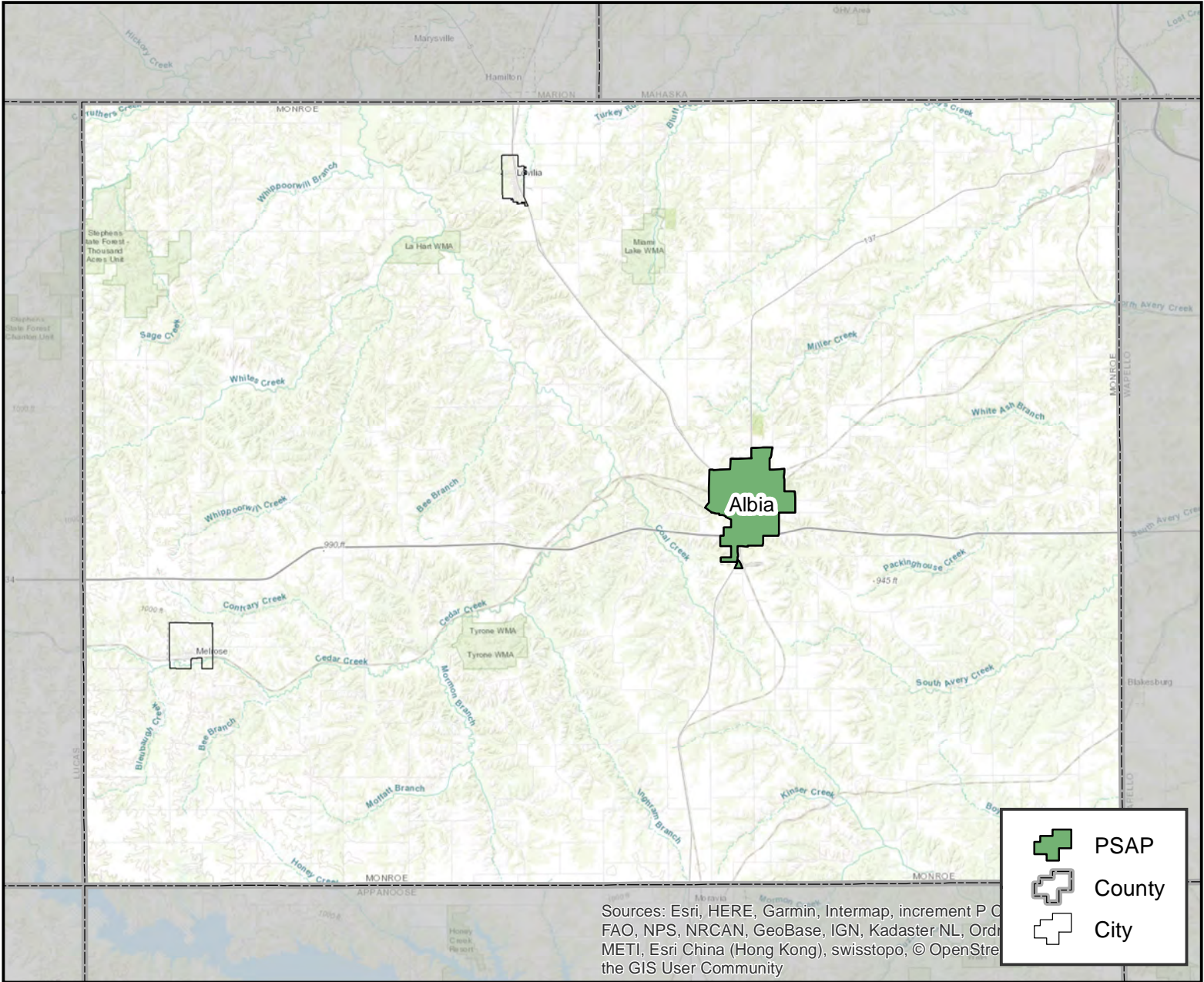

- PSAP
- County
- City

Sources: Esri, HERE, Garmin, Intermap, increment P Corp., FAO, NPS, NRCAN, GeoBase, IGN, Kadaster NL, Ordnance Survey, Esri China (Hong Kong), Swisstopo, © OpenStreetMap contributors, and the GIS User Community

PSAP Information
Monroe County Sheriff Office
FCC #: 1990
Phone #: 641-932-7815
114 19th Ave West Albia, IA 52531

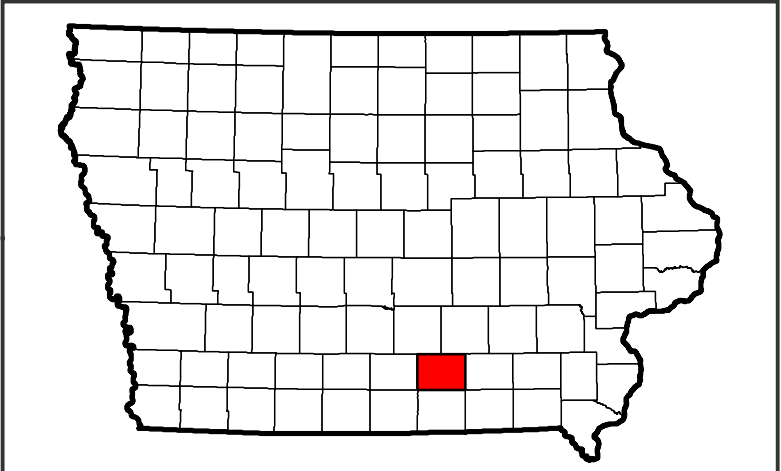

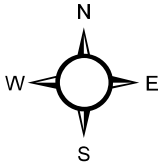

Montgomery County

Red Oak, Iowa

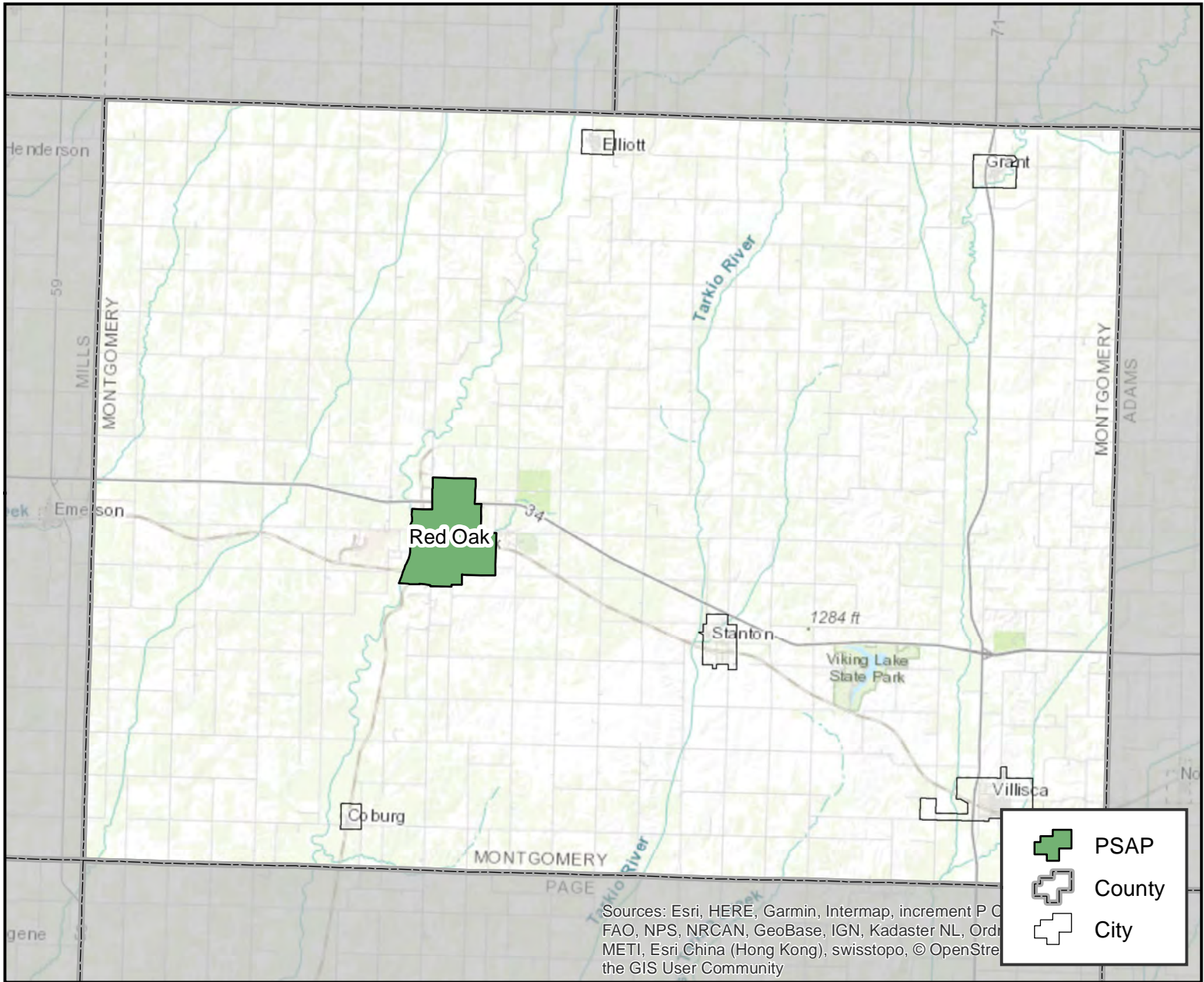

PSAP Information

Montgomery Co Sheriffs Office
FCC #: 1991
Phone #: 712-623-5107
106 W Coolbaugh St Red Oak, IA 51566

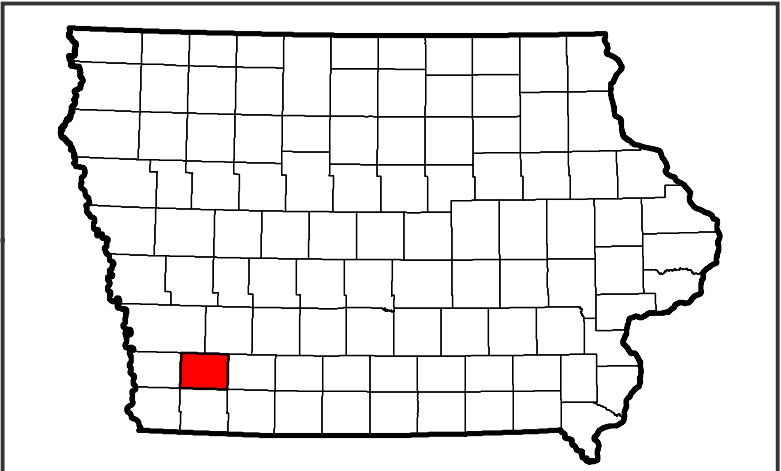

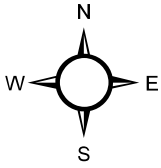

Muscatine County

Muscatine, Iowa

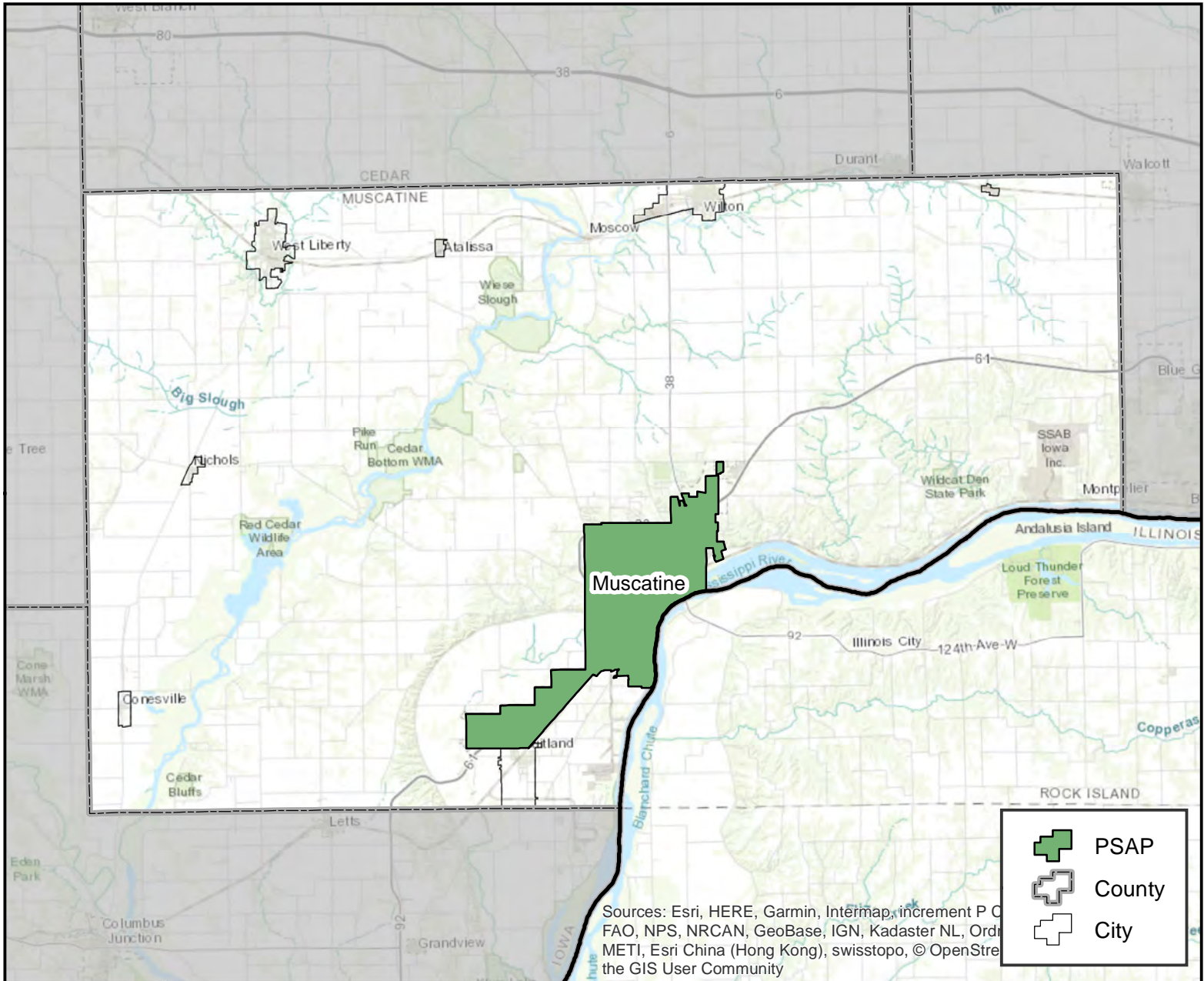

PSAP Information

MUSCOM
FCC #: 1992
Phone #: 563-262-4159
312 East 5th Street Muscatine, IA 52761

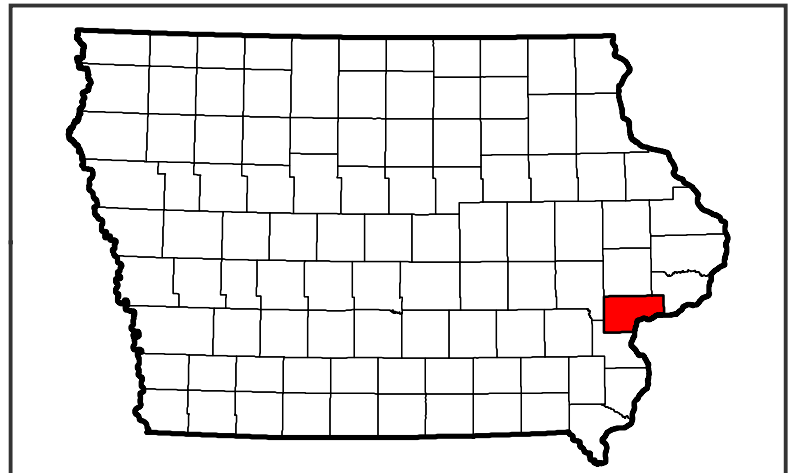

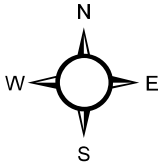

O' Brien County

Primghar, Iowa

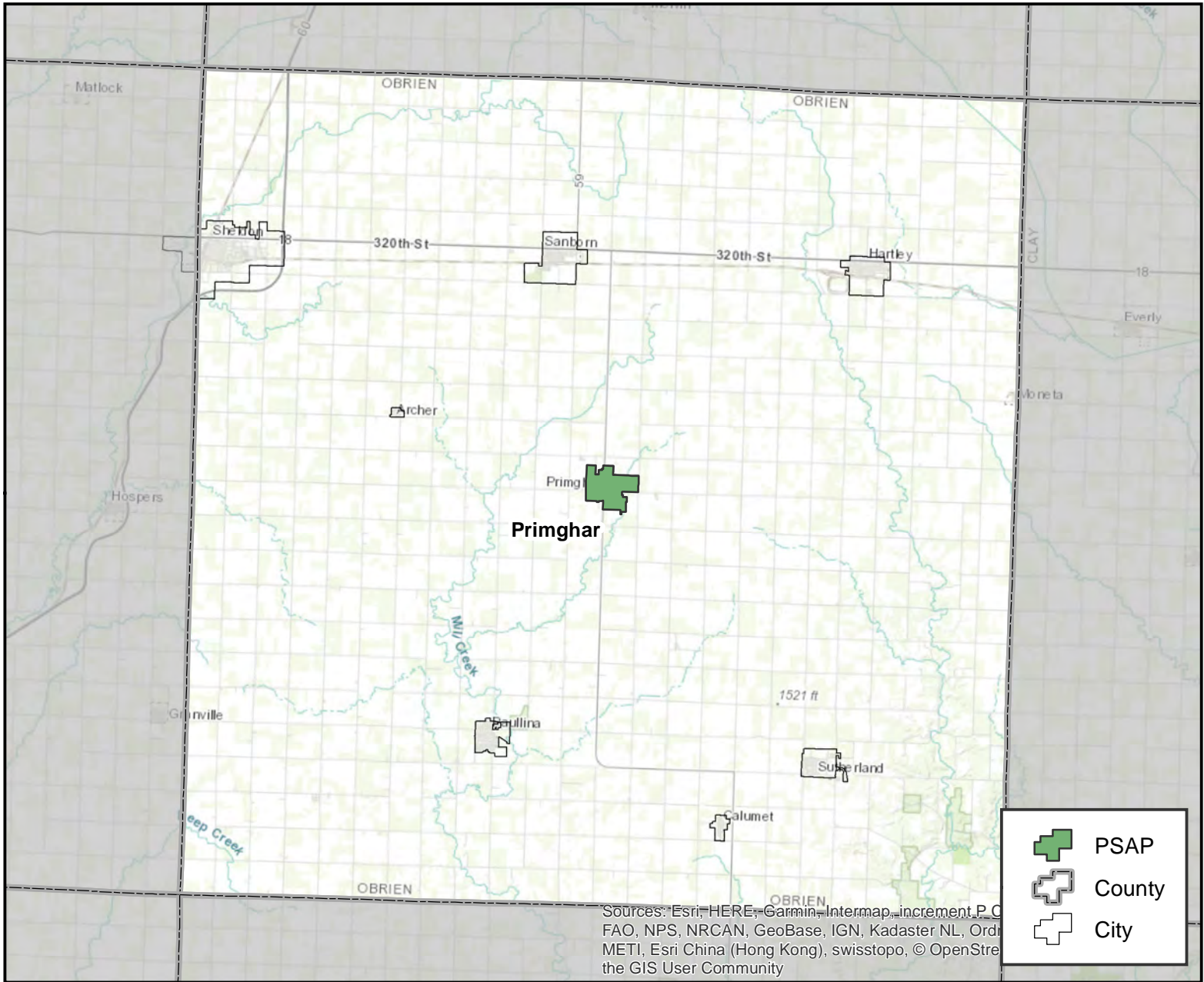

PSAP Information

O'Brien County Sheriff
FCC #: 1994
Phone #: 712-757-3415
240 1st Street N.E. Primghar, IA 51245

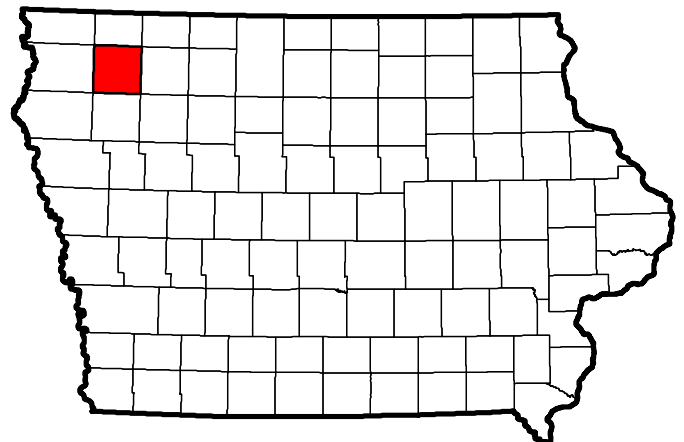

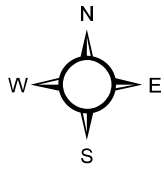

Osceola County

Sibley, Iowa

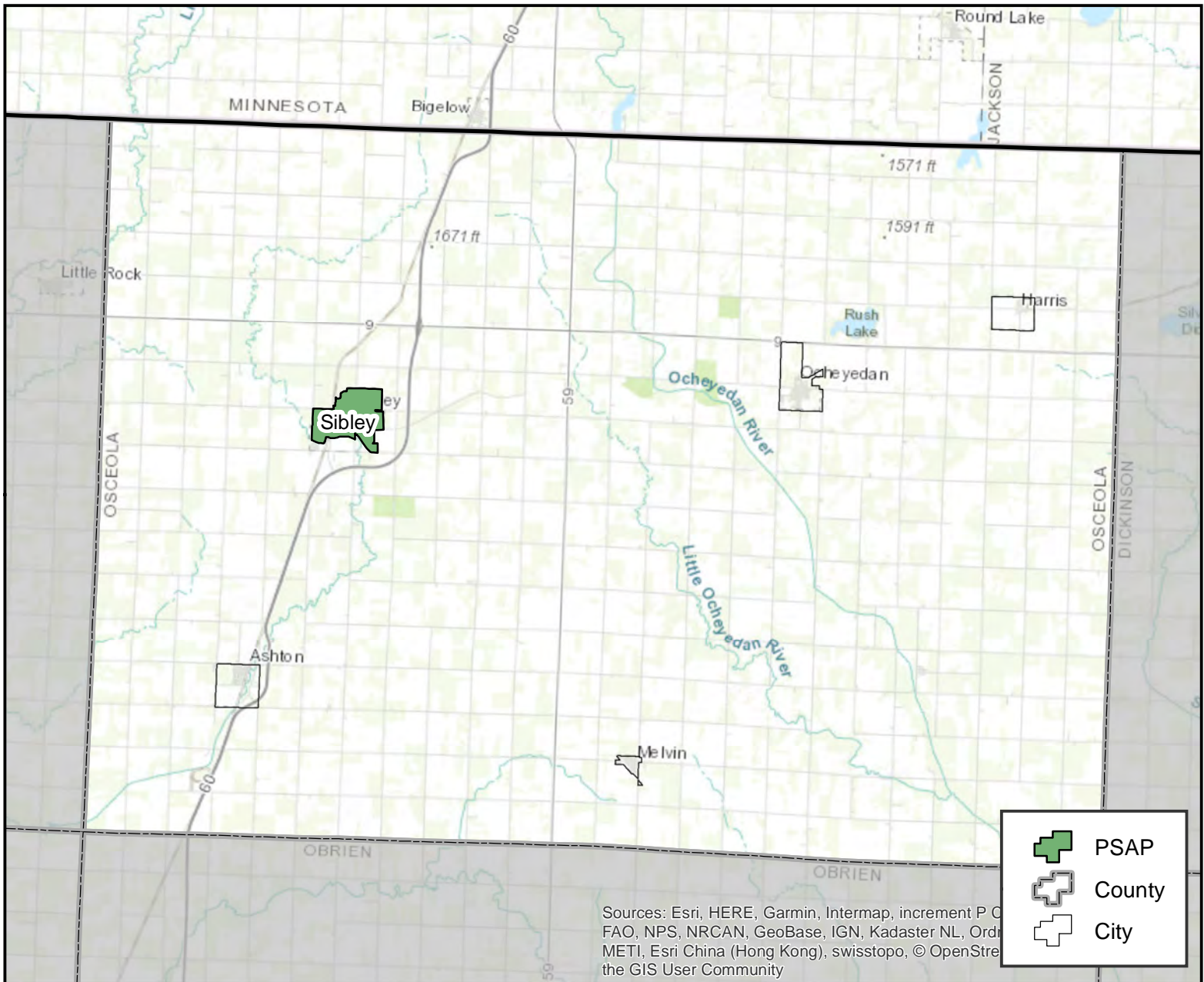

PSAP Information

Osceola County Sheriffs Office
FCC #: 1996
Phone #: 712-754-2556
309 6th Street Sibley, IA 51249

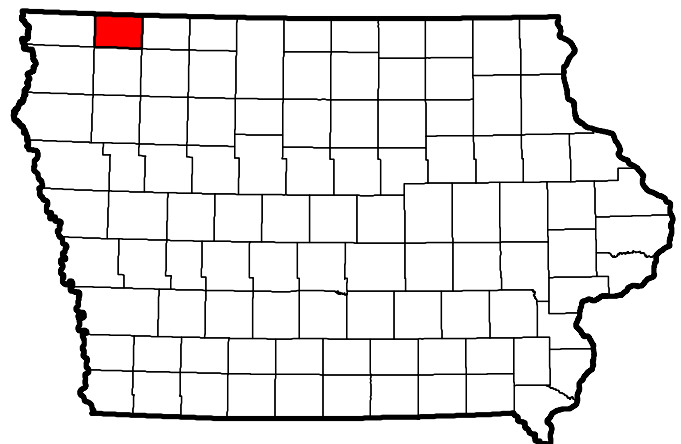

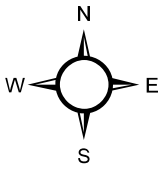

Page County

Clarinda, Iowa

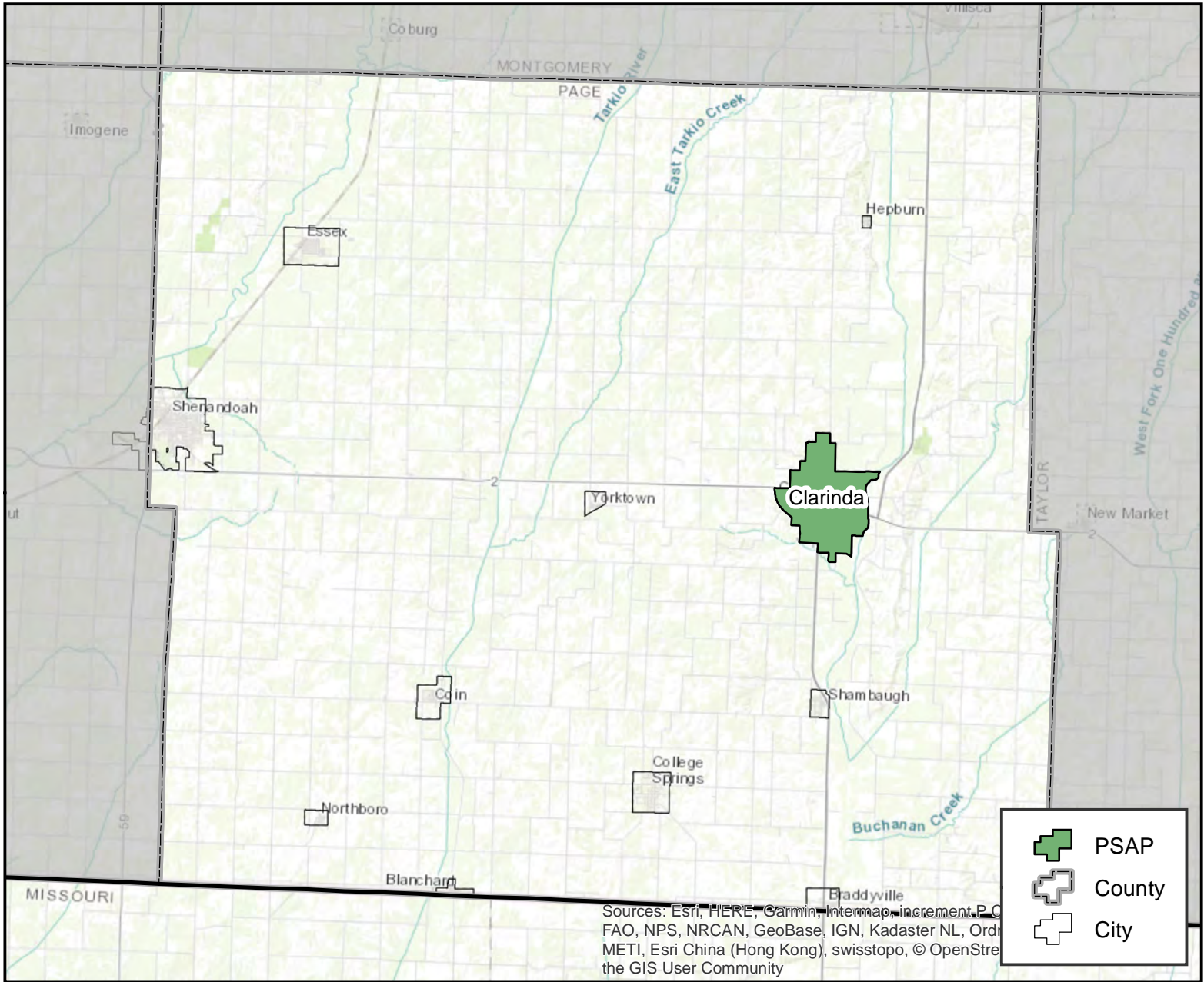

PSAP Information

Page County Communications Center
FCC #: 1920
Phone #: 712-542-1419
200 S. 15th St Clarinda, IA 51632

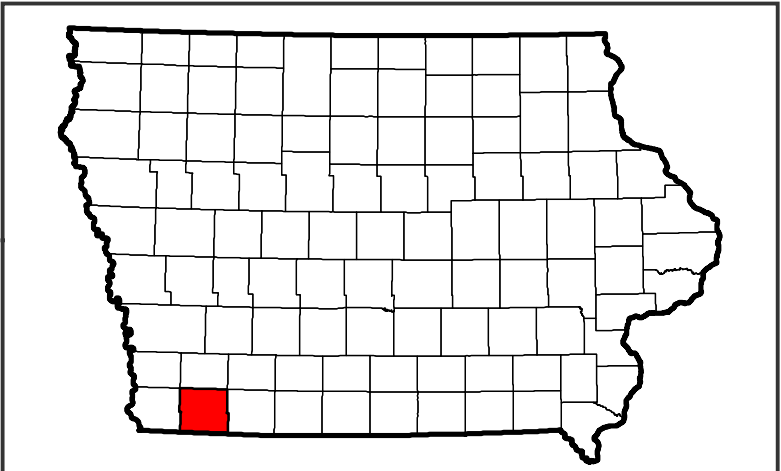

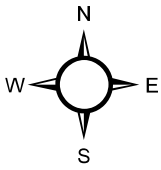

Palo Alto County

Emmetsburg, Iowa

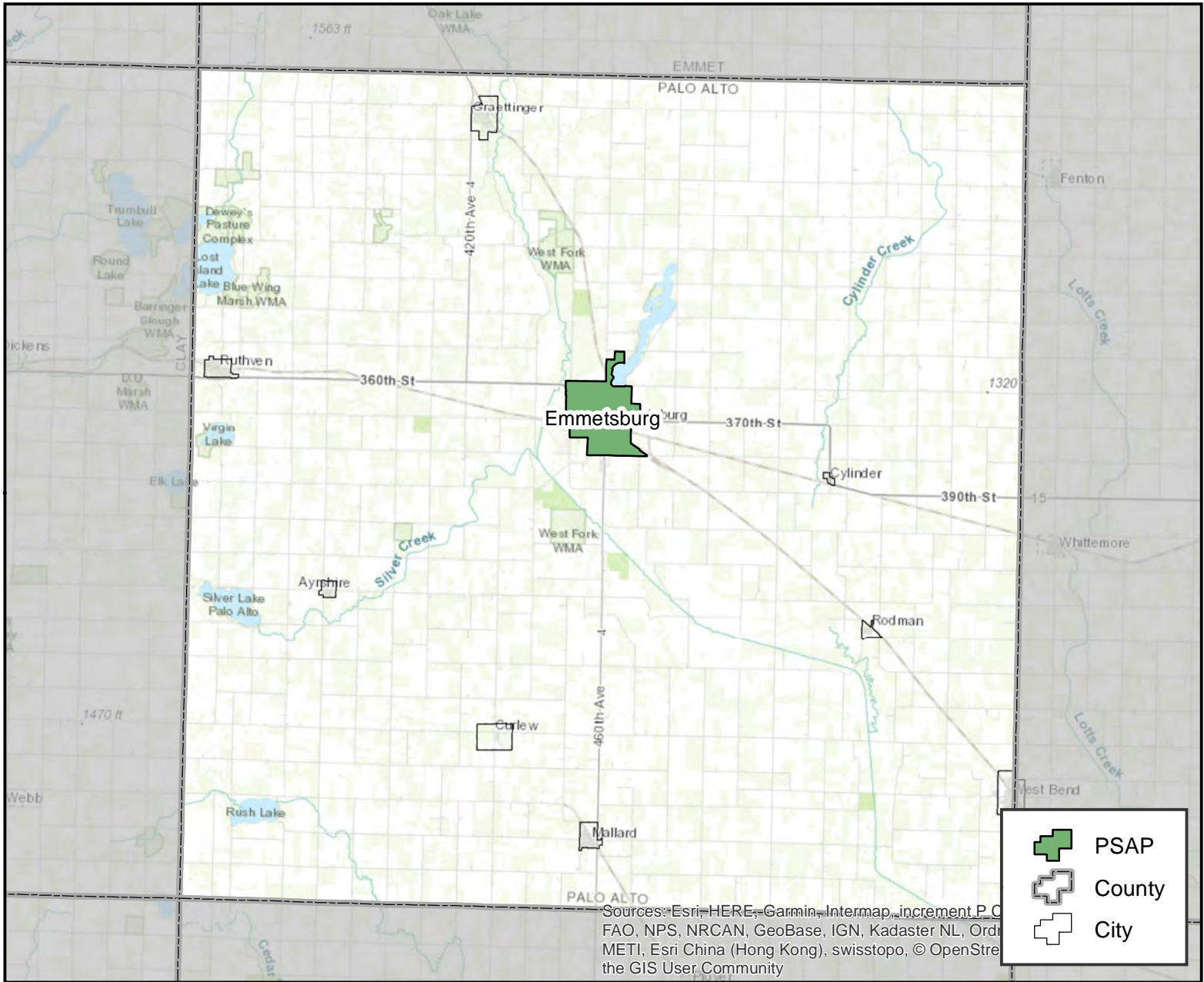

PSAP Information

Palo Alto Communications Center
FCC #: 1999
Phone #: 712-852-3535
2001 11th St Emmetsburg , IA 50536

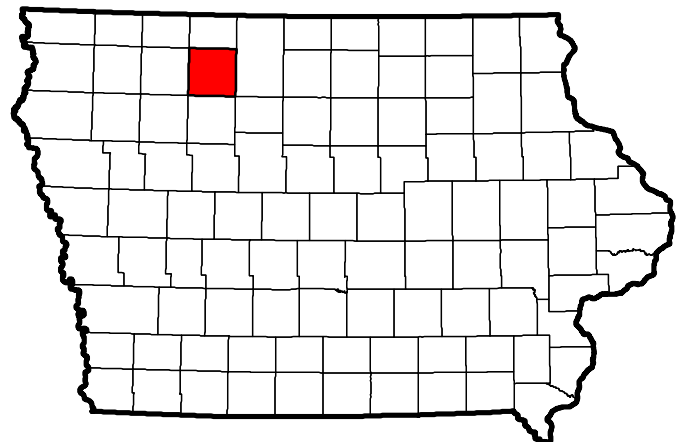

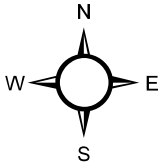

Plymouth County

Le Mars, Iowa

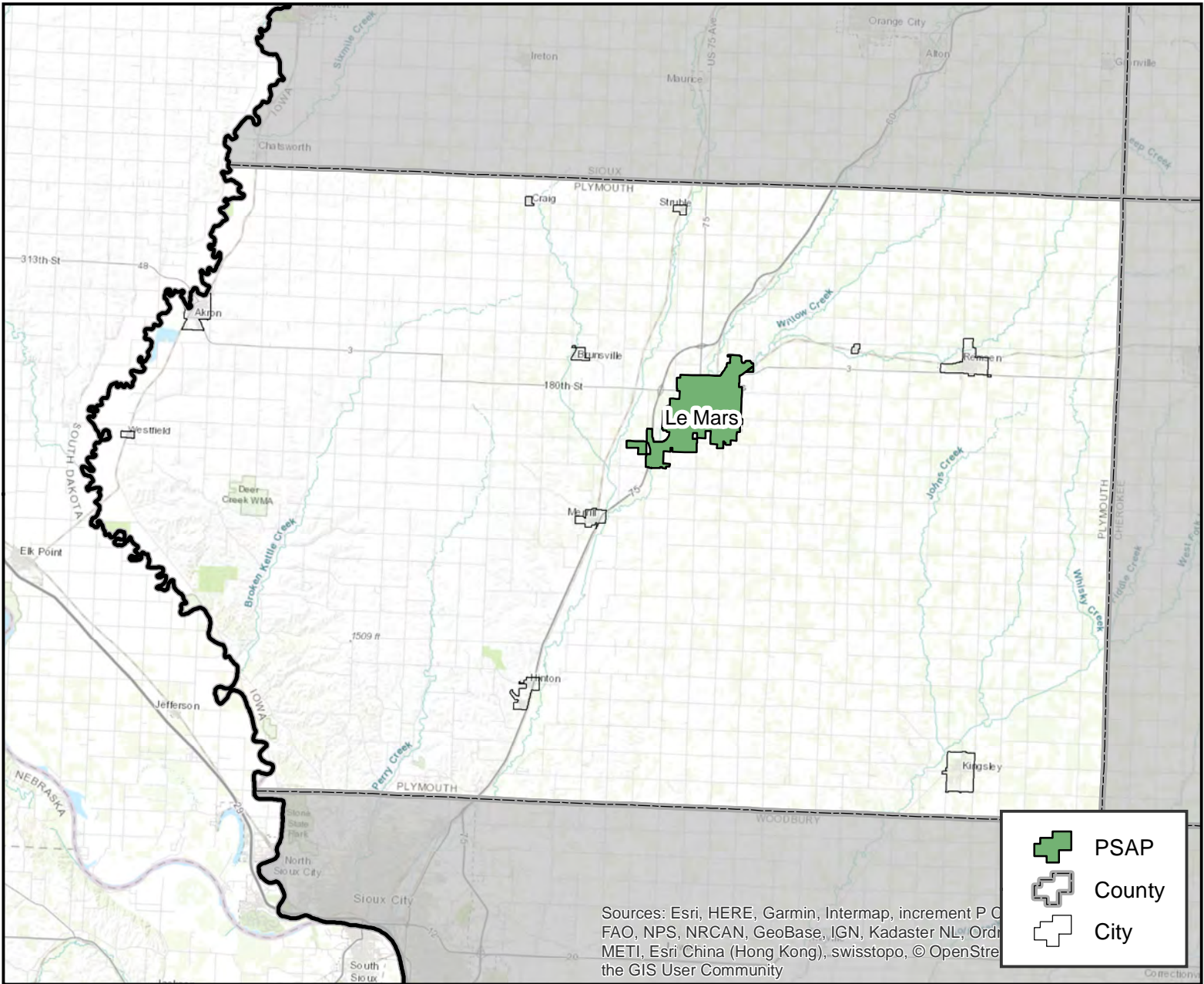

PSAP Information

Plymouth County Sheriff Office
FCC #: 2002
Phone #: 712-546-8760
451 14th Ave NE LeMars, IA 51031

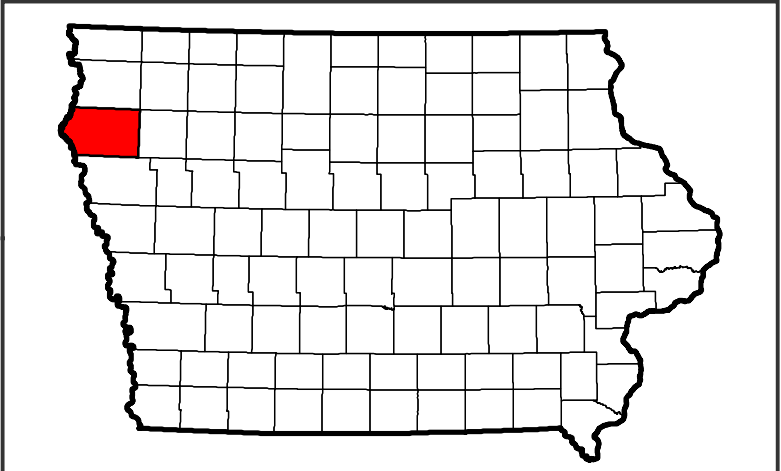

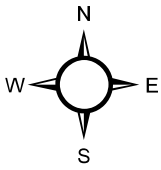

Pocahontas County

Pocahontas, Iowa

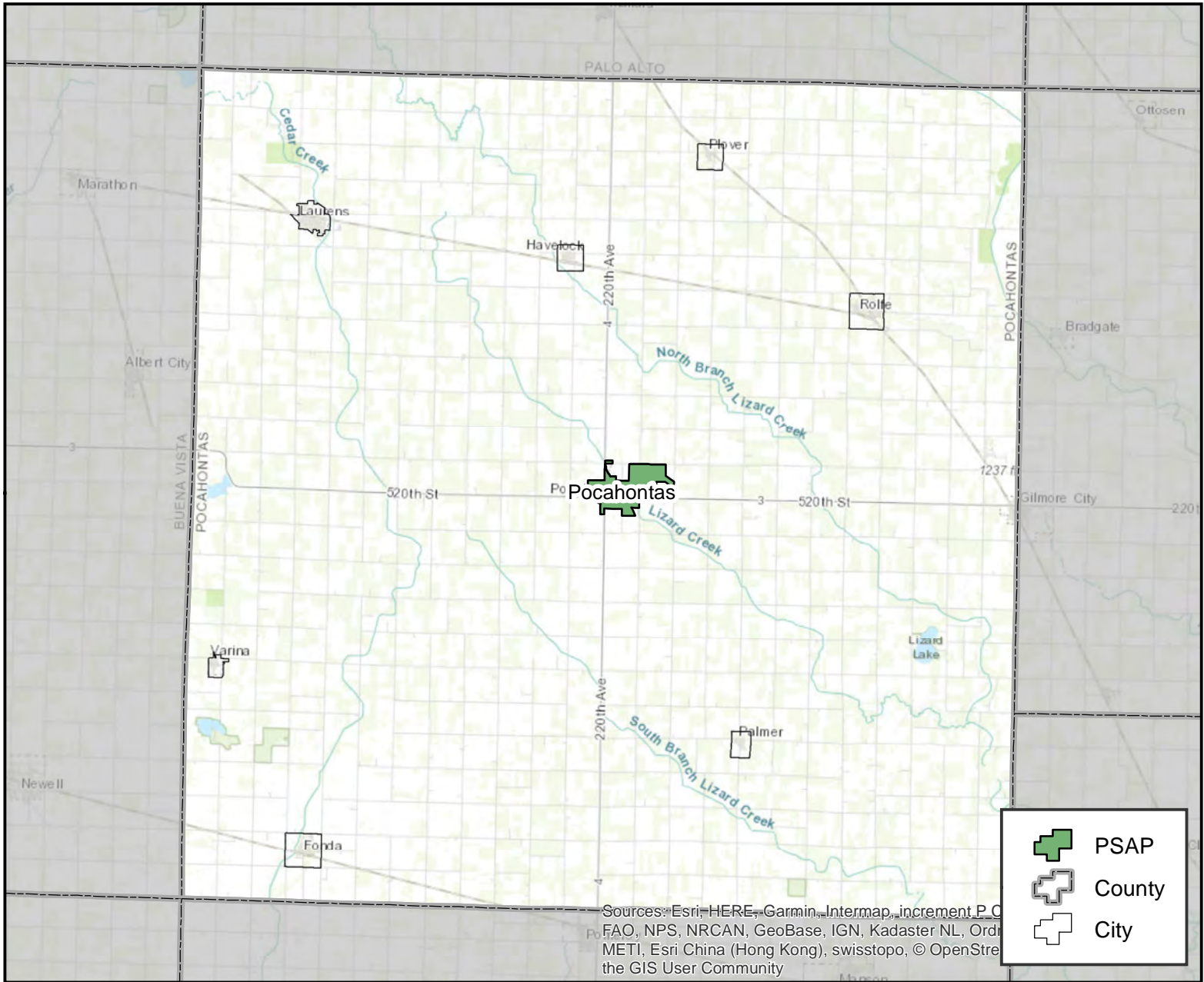

PSAP Information

Pocahontas Sheriff's Office
FCC #: 2003
Phone #: 712-335-3308
99 Court Square Ste 9 Pocahontas IA 50574

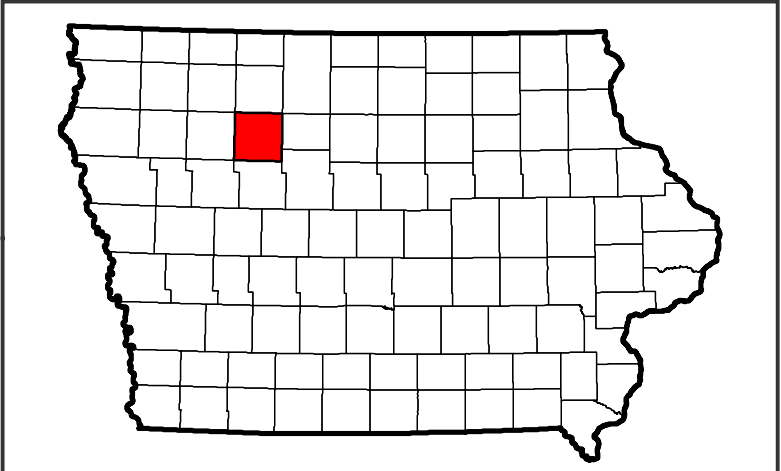

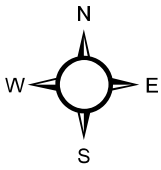

Polk County

Des Moines, Iowa

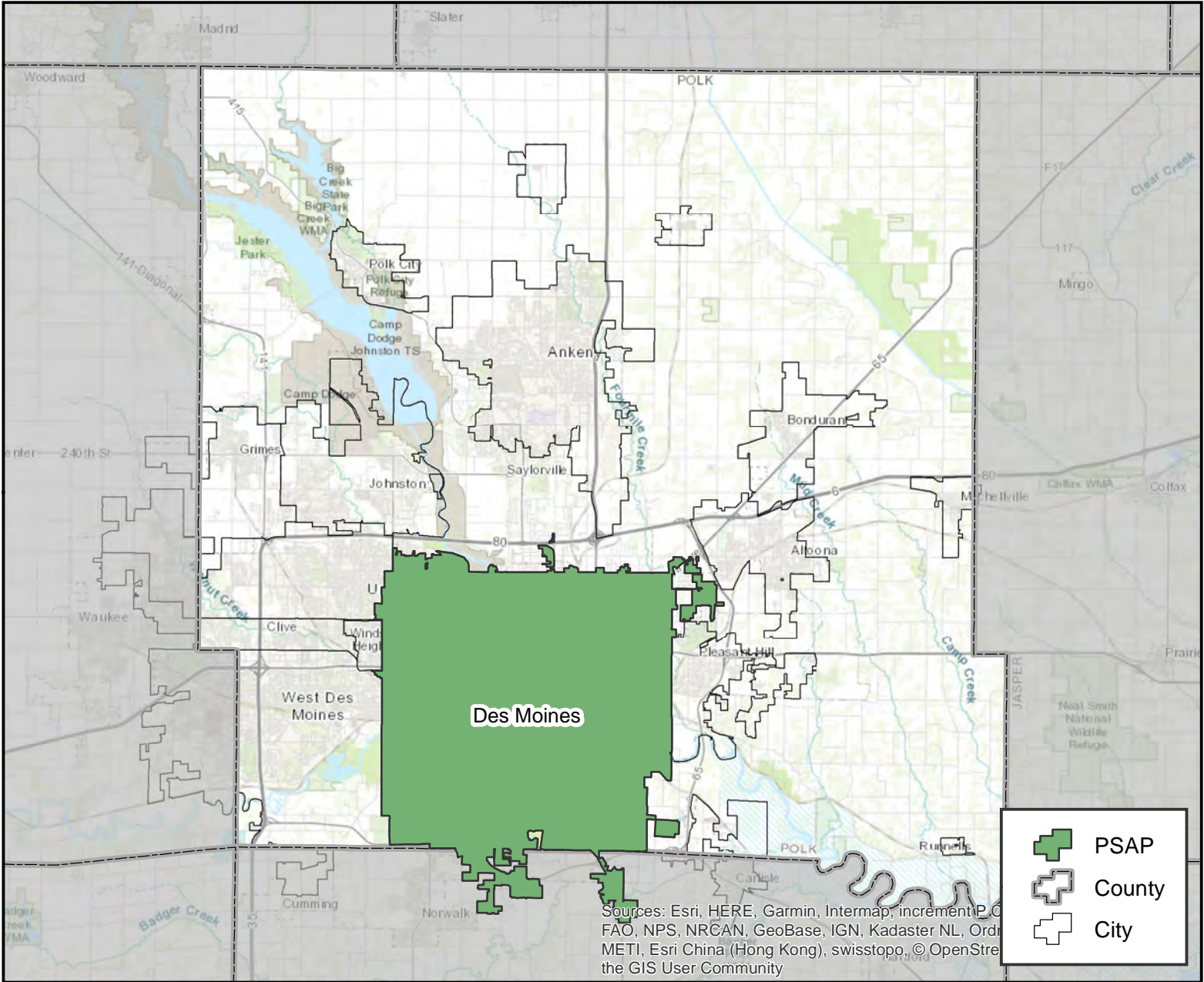

PSAP Information

Des Moines Police Department
FCC #: 1937
Phone #: 515-283-4811
25 East 1st Street Des Moines, IA 50309

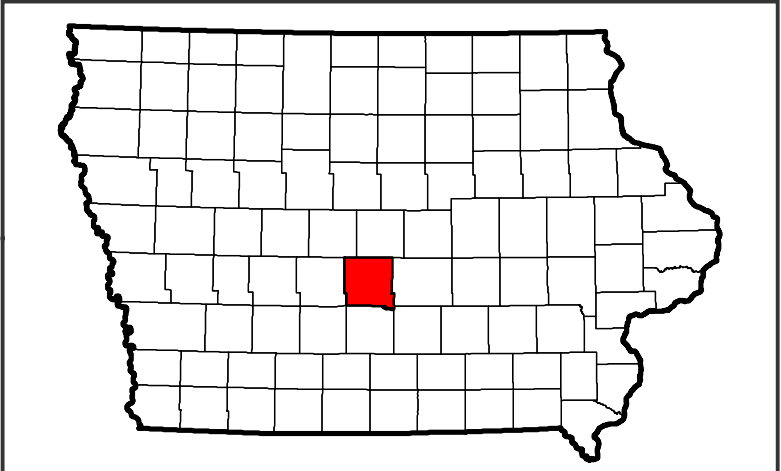

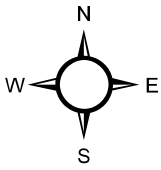

Polk County

Johnston, Iowa

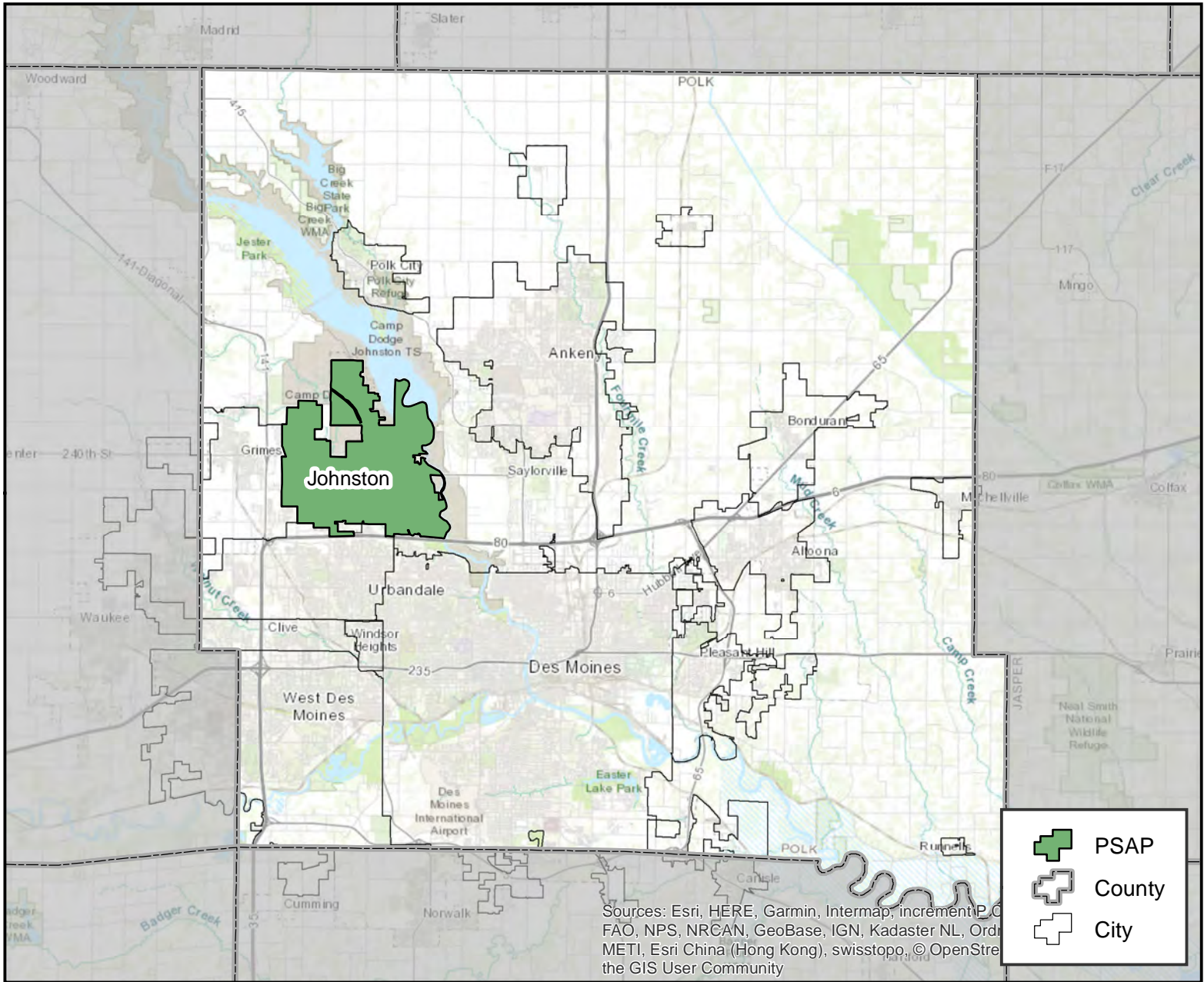

PSAP Information

Johnston Comm Center-STARC Army
FCC #: 1969
Phone #: 515-323-4360
6100 NW 78th Avenue, Johnston, IA 50131

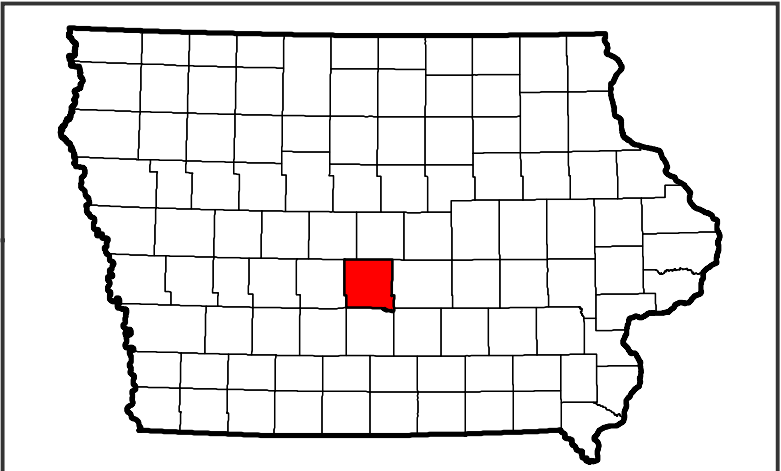

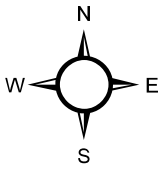

Polk County

Des Moines, Iowa

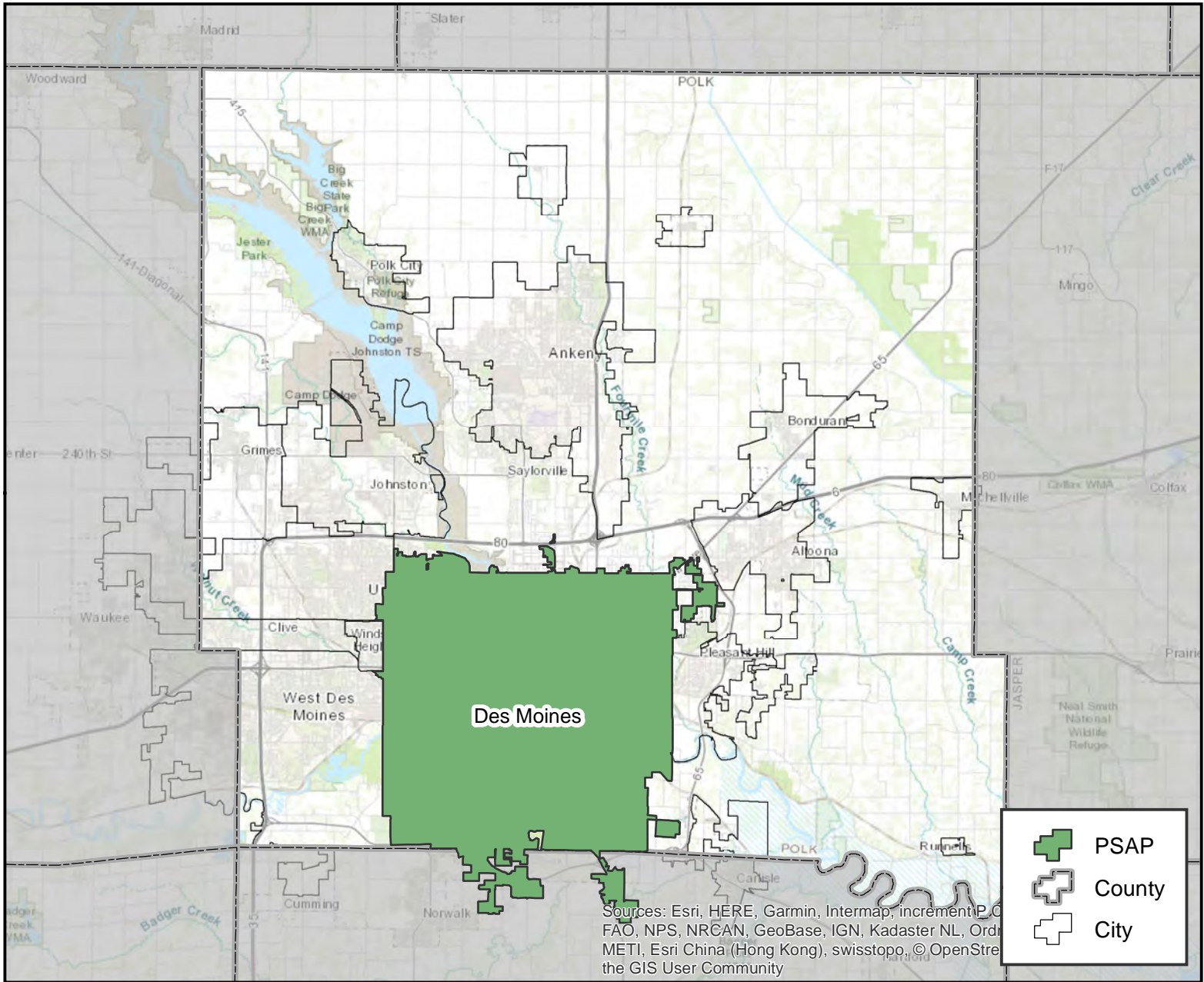

PSAP Information

Polk County Sheriff's Office
FCC #: 2004
Phone #: 515-286-3333
6023 NE 14th Street Des Moines, IA 50313

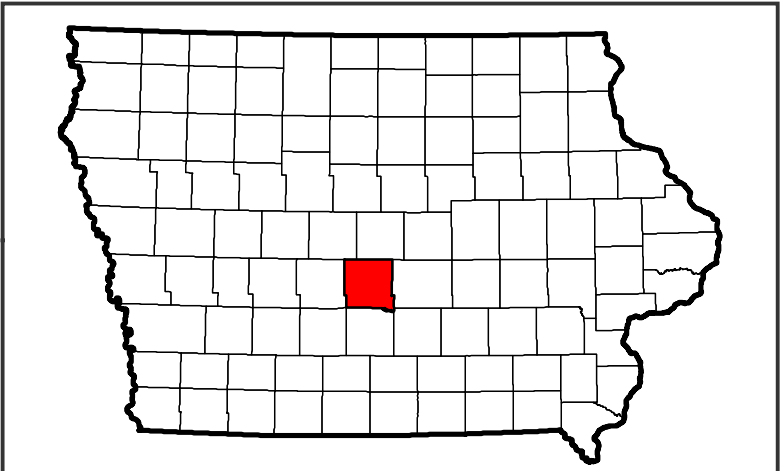

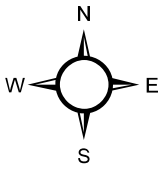

Polk County

West Des Moines, Iowa

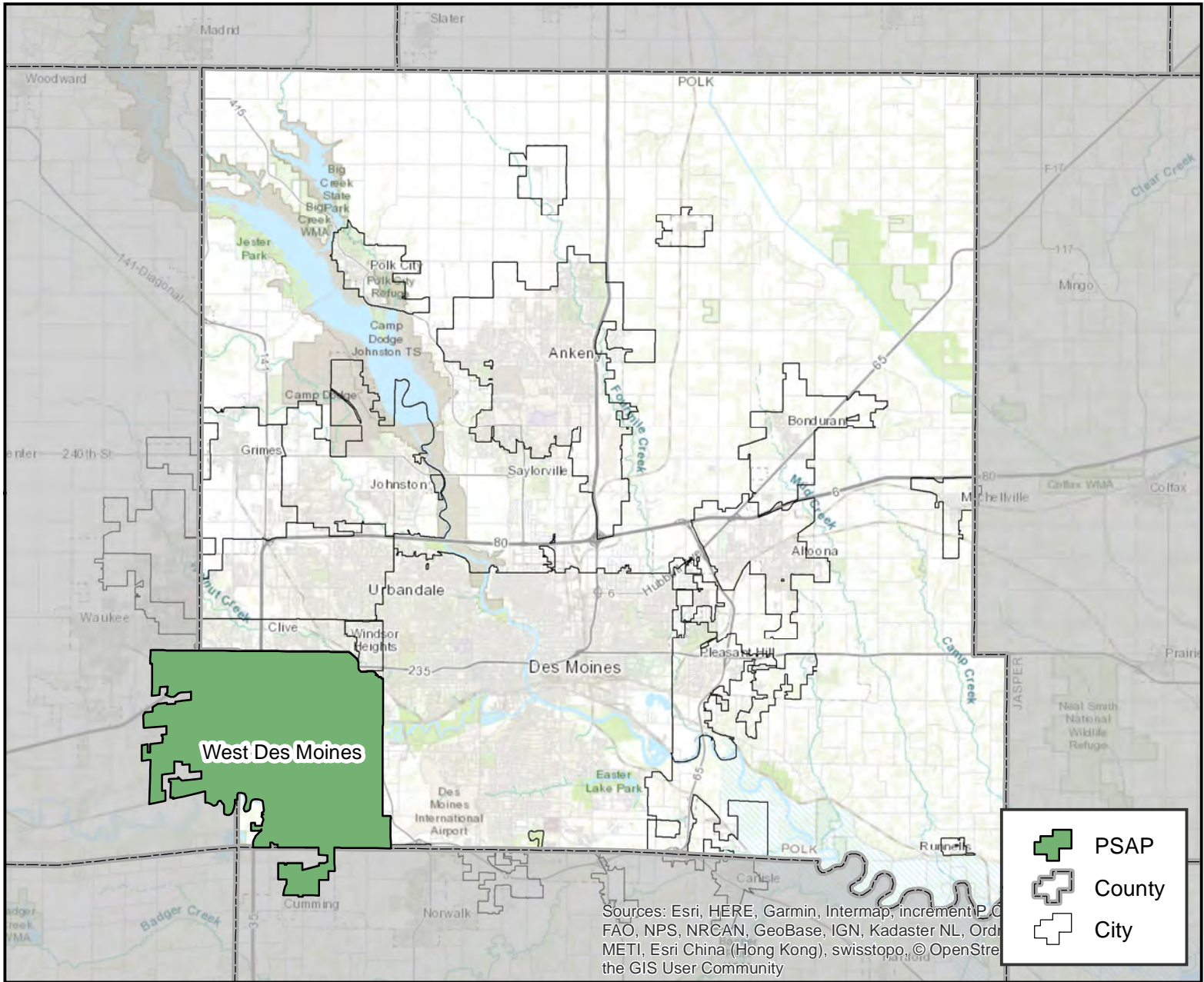

PSAP Information

Westcom Emergency Communications

FCC #: 2028

Phone #: 515-222-3321

8055 Mills Civic Parkway West Des Moines, IA 50265

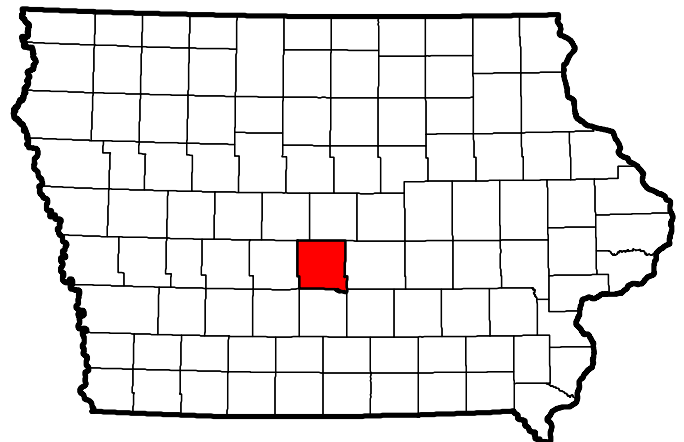

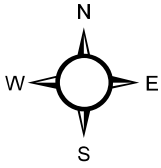

Pottawattamie County

Council Bluffs, Iowa

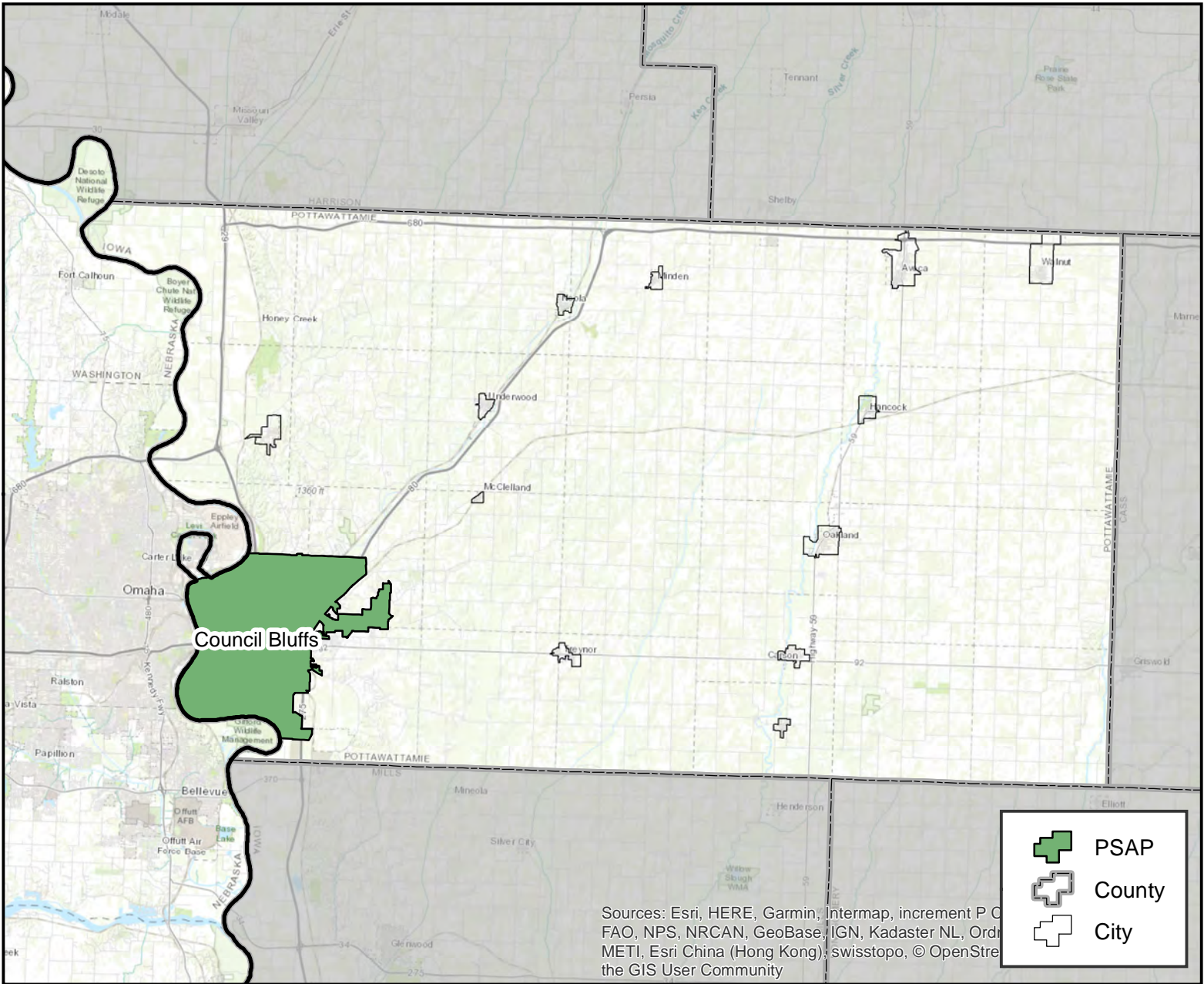

PSAP Information

Pottawattamie County Law Enforcement 911 Center
FCC #: 2005
Phone #: 712-328-5737
227 S 6th Street Council Bluffs, IA 51501

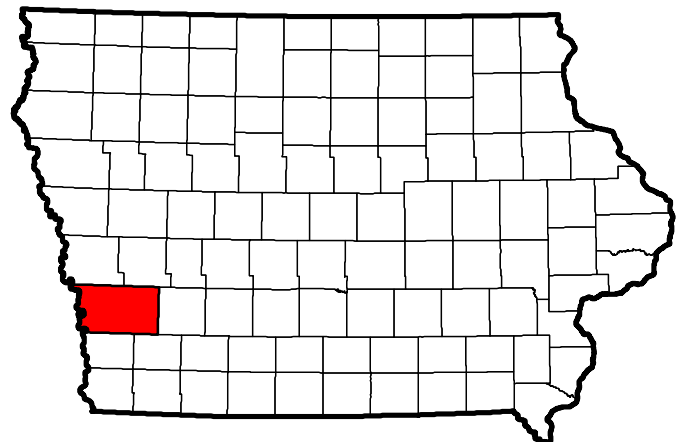

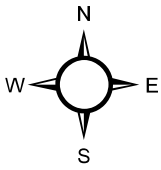

Poweshiek County

Montezuma, Iowa

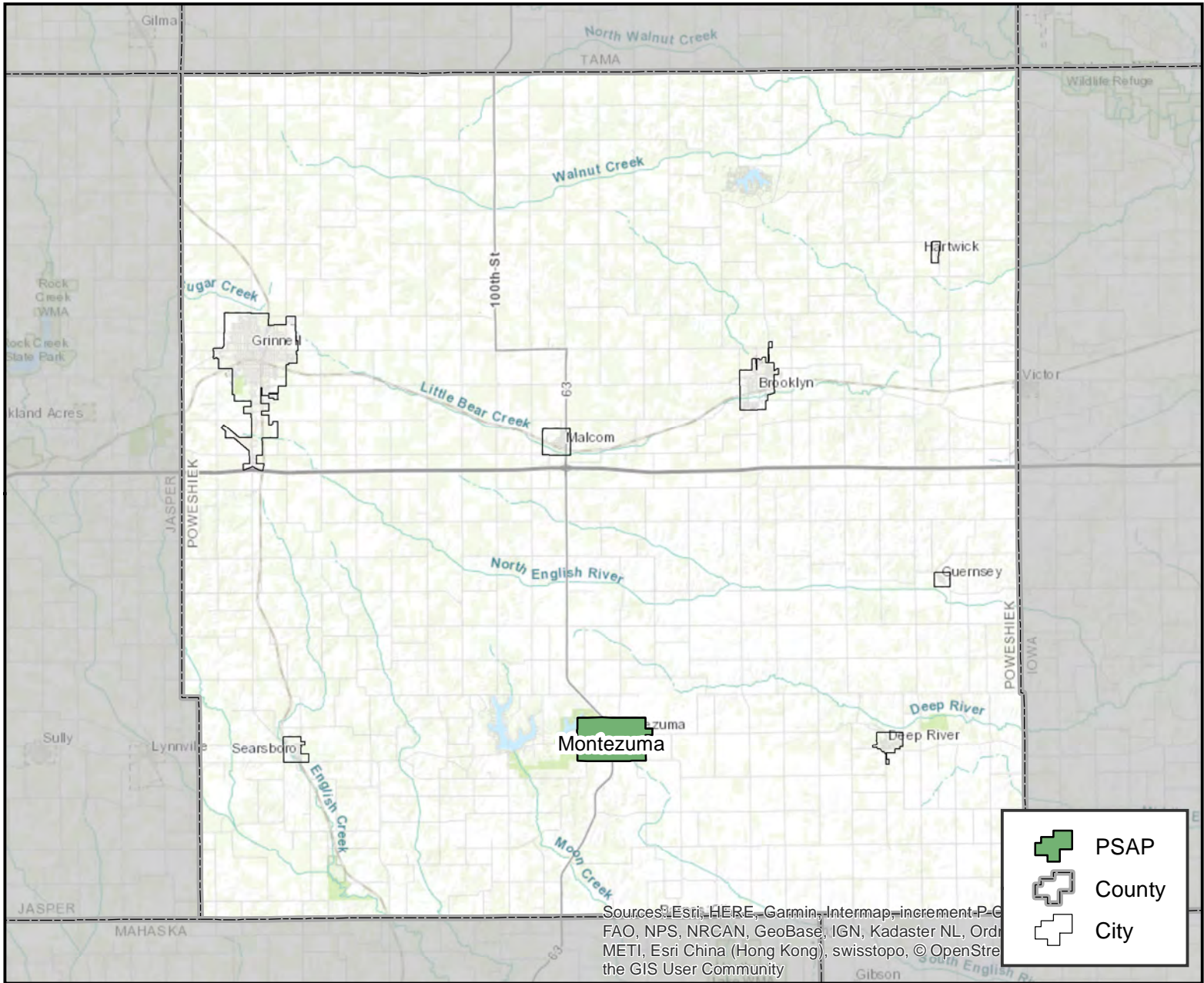

PSAP Information

Poweshiek County
FCC #: 2006
Phone #: 641-623-5679
4802 Barnes City Road Montezuma, IA 50171

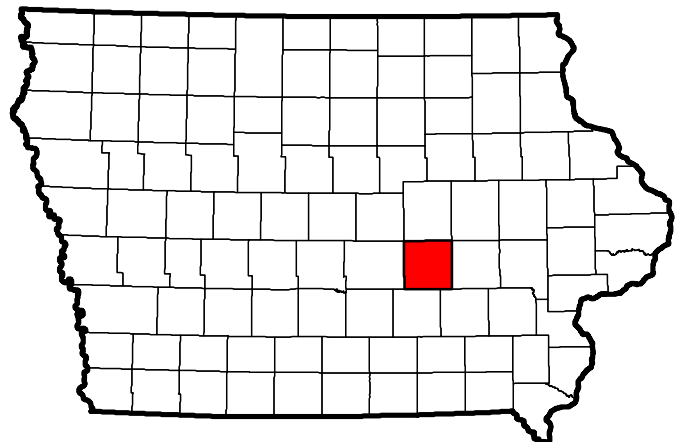

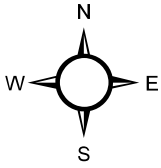

Ringgold County

Mount Ayr, Iowa

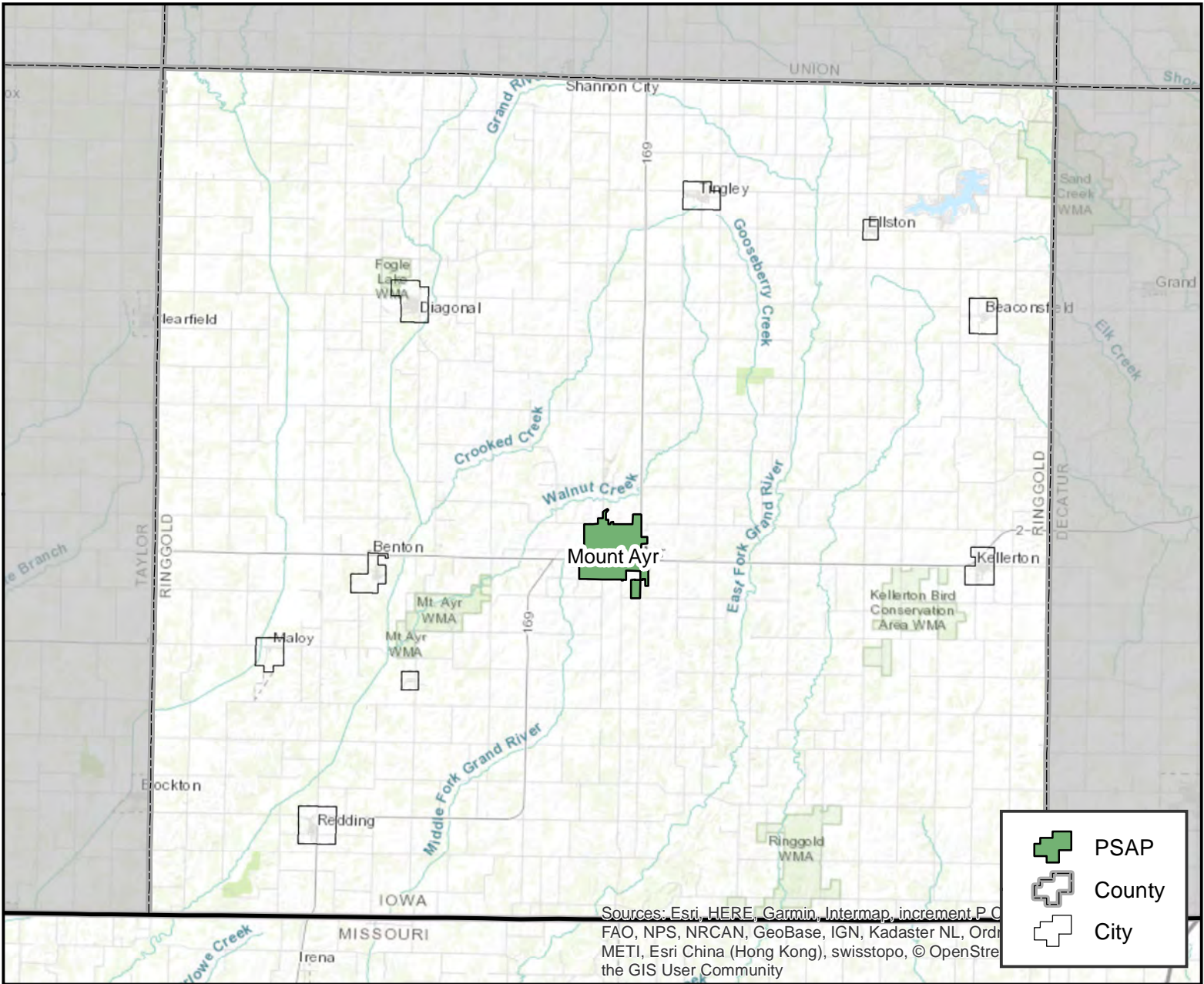

PSAP Information

Ringgold County Sheriff Office
FCC #: 2007
Phone #: 641-344-9691
801 W South Street Mount Ayr, IA 50854

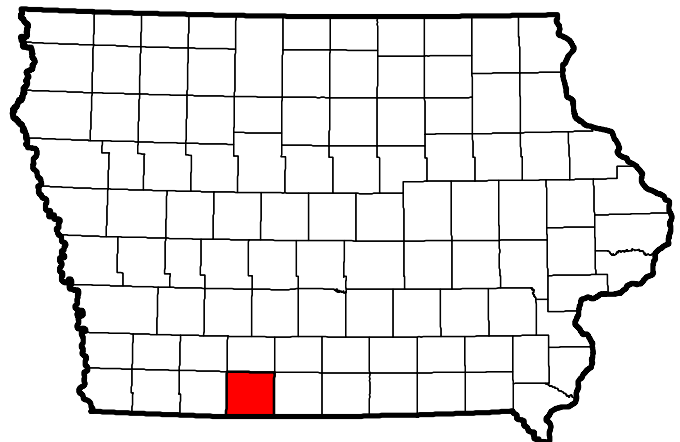

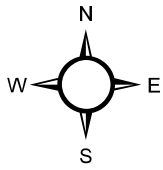

Sac County

Sac City, Iowa

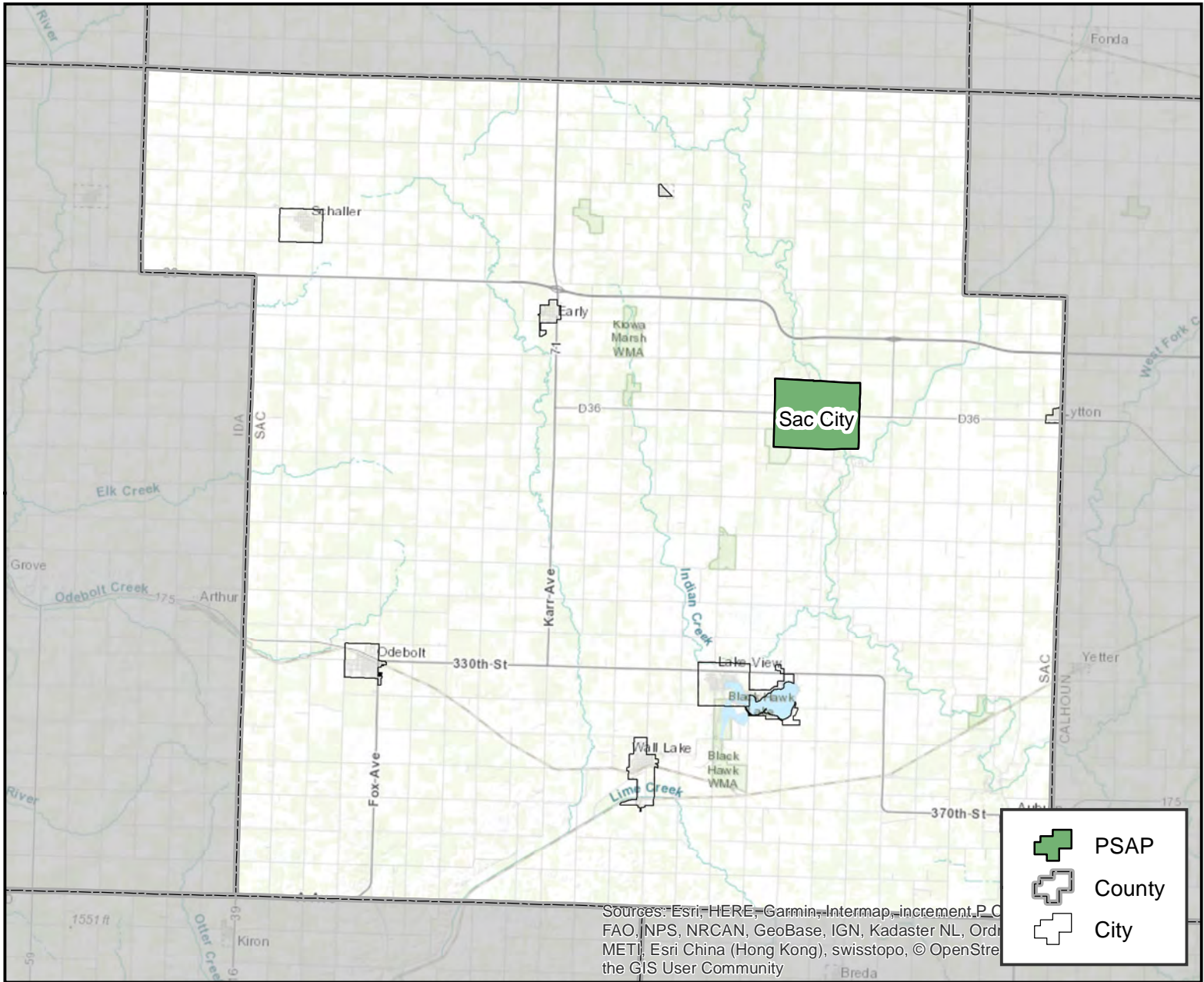

PSAP Information

Sac Co Sheriff's Office
FCC #: 2008
Phone #: 712-662-7127
116 S State St Suite C Sac City, IA 50583

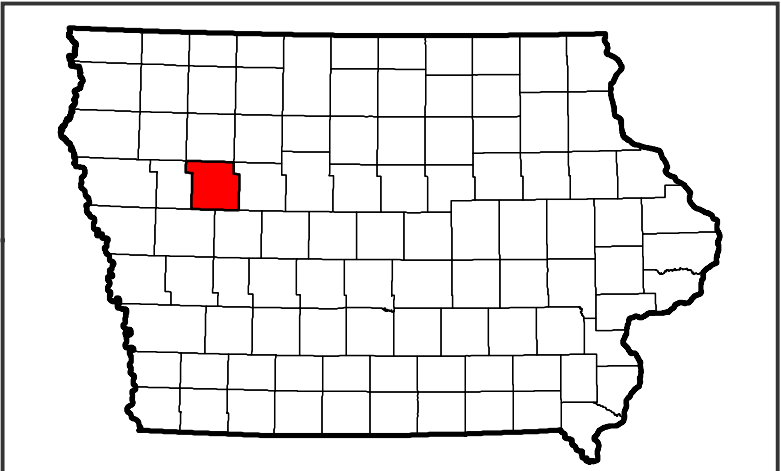

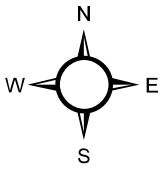

Scott County

Davenport, Iowa

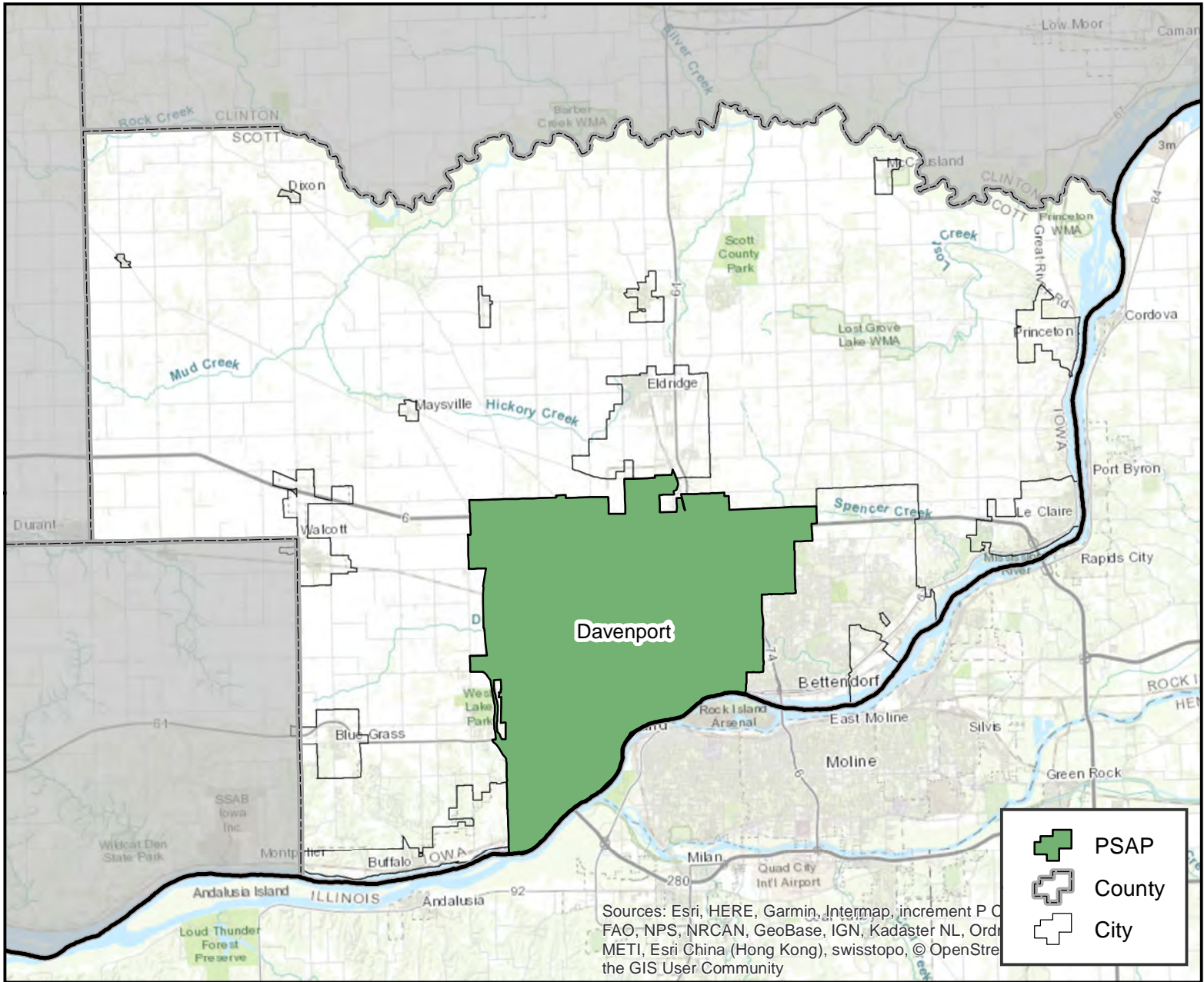

PSAP Information

Scott Emergency Communications Center (SECC)
FCC #: 2009
Phone #: 563-388-3661
1100 E. 46th Street Davenport, IA 52807

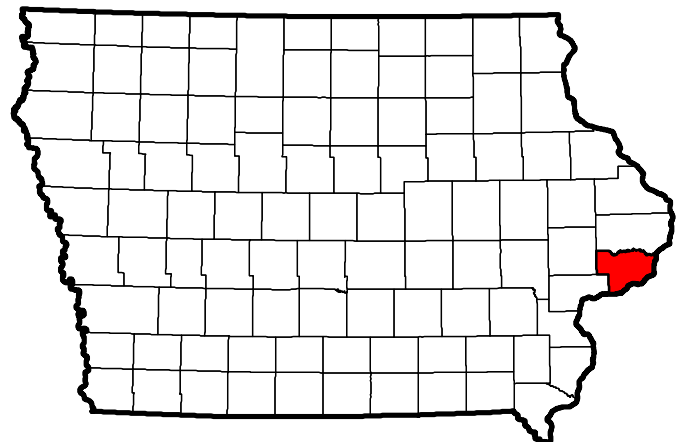

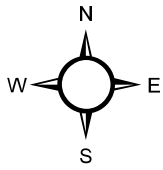

Shelby County

Harlan, Iowa

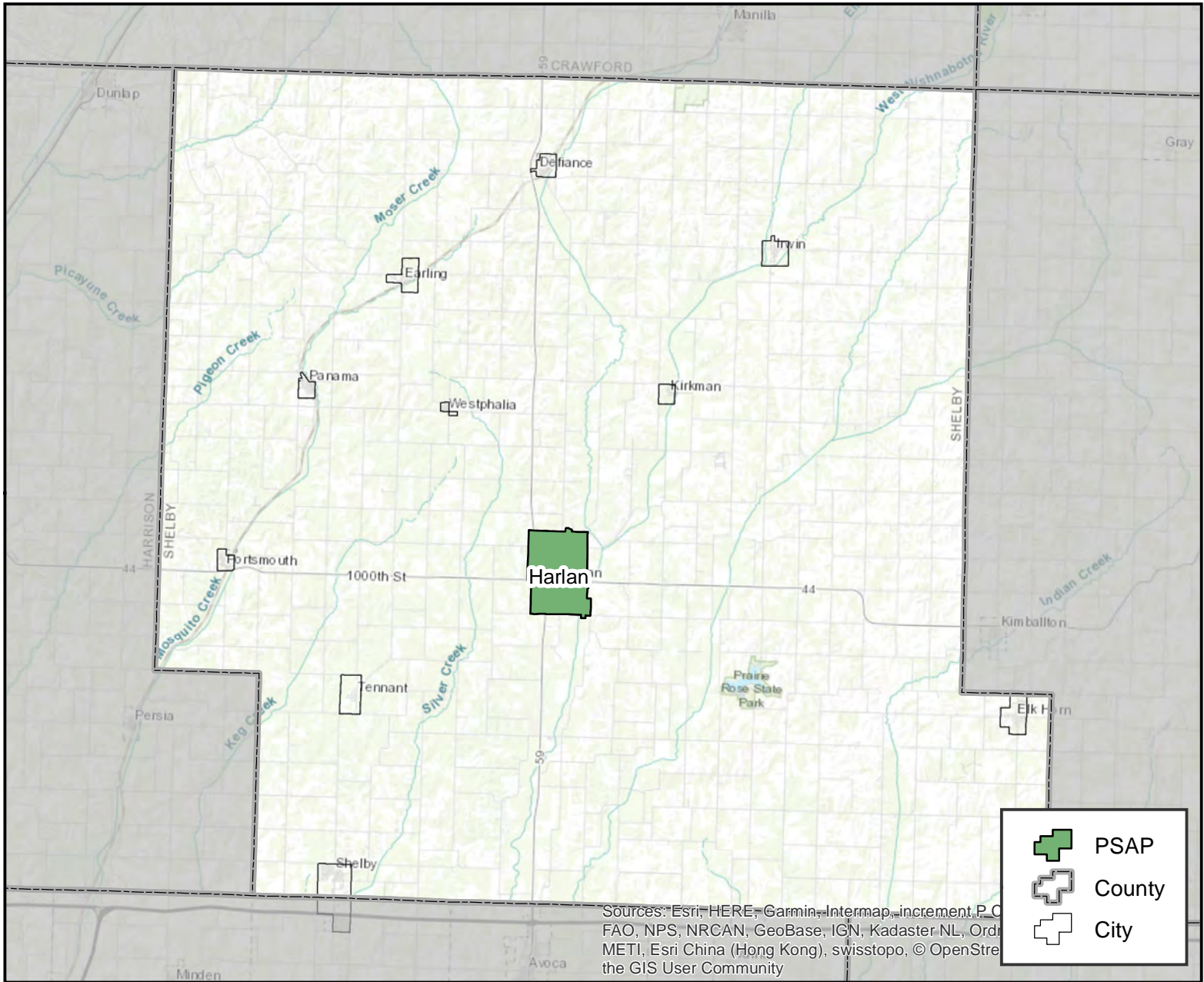

Sources: Esri, HERE, Garmin, Intermap, increment.P.C., FAO, NPS, NRCAN, GeoBase, IGN, Kadaster NL, Ordnance Survey, Esri China (Hong Kong), swisstopo, © OpenStreetMap contributors, and the GIS User Community

- PSAP
- County
- City

PSAP Information
Shelby County Communications
FCC #: 2010
Phone #: 712-755-2124
1106 9th Street Harlan, IA 51537

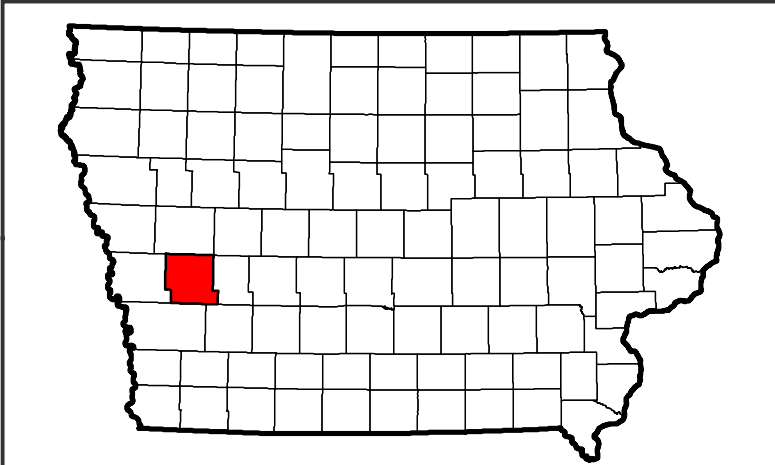

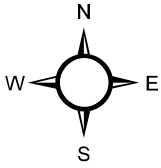

Sioux County

Orange City, Iowa

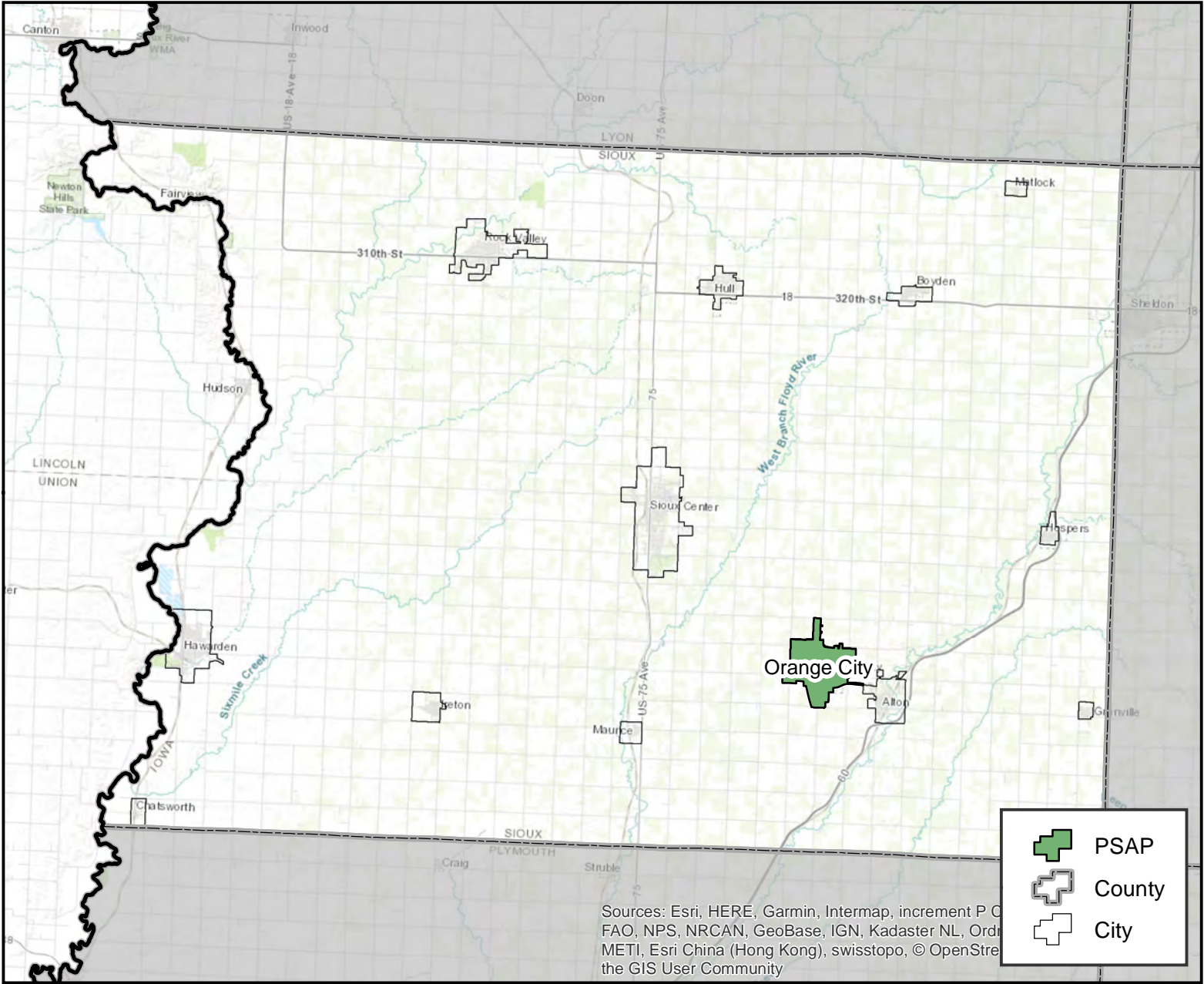

PSAP Information

Sioux County Sheriff's Office
FCC #: 2014
Phone #: 712-737-3307
4363 Ironwood Ave Orange City, IA 51041

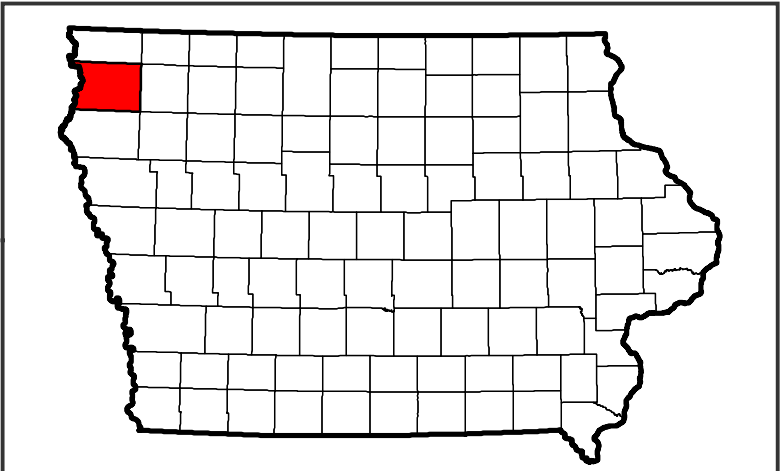

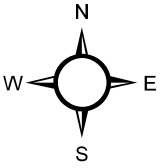

Story County

Ames, Iowa

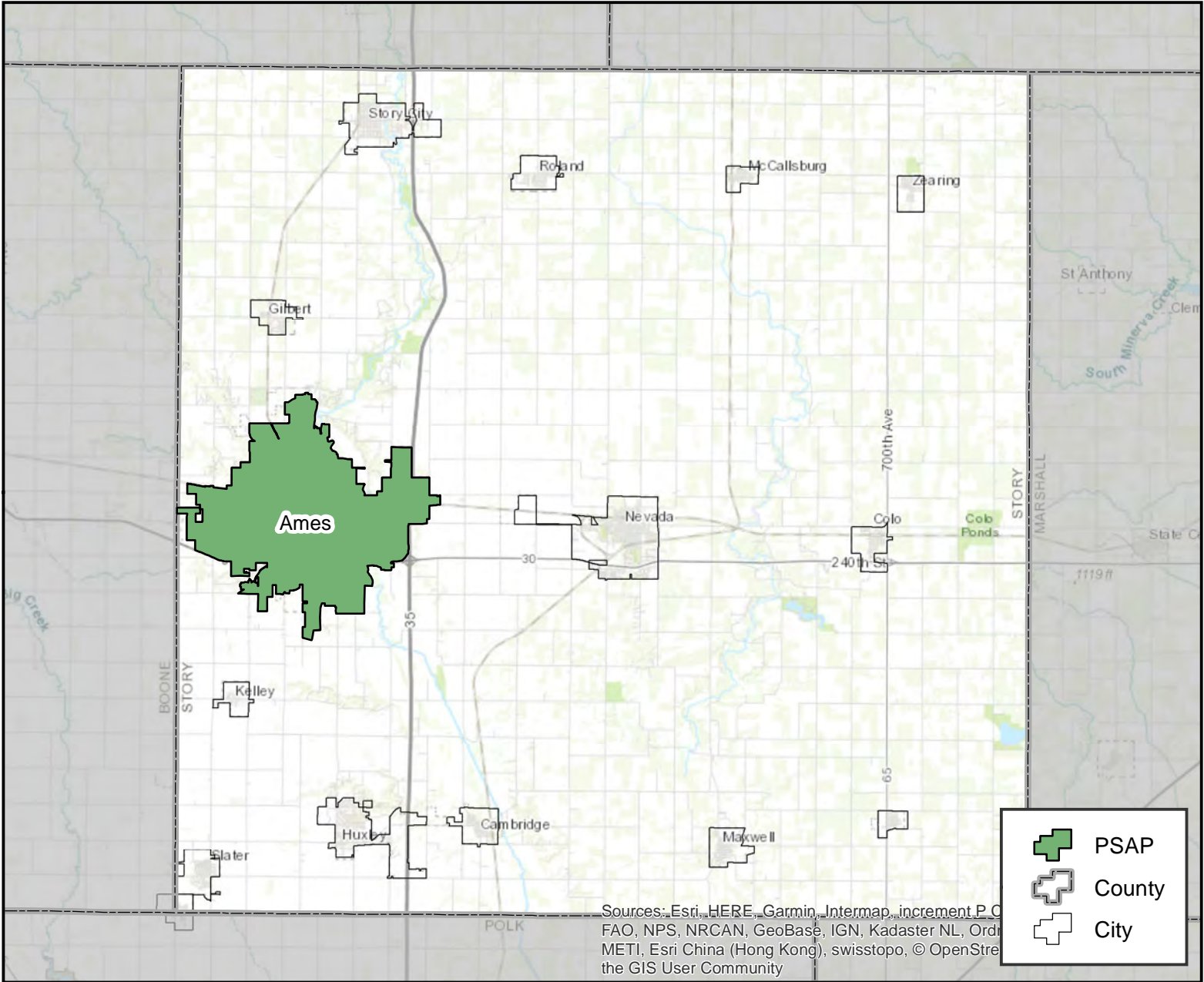

PSAP Information

Ames Police Department FCC
#: 1894
Phone #: 515-239-5133
515 Clark Ave Ames, IA 50010

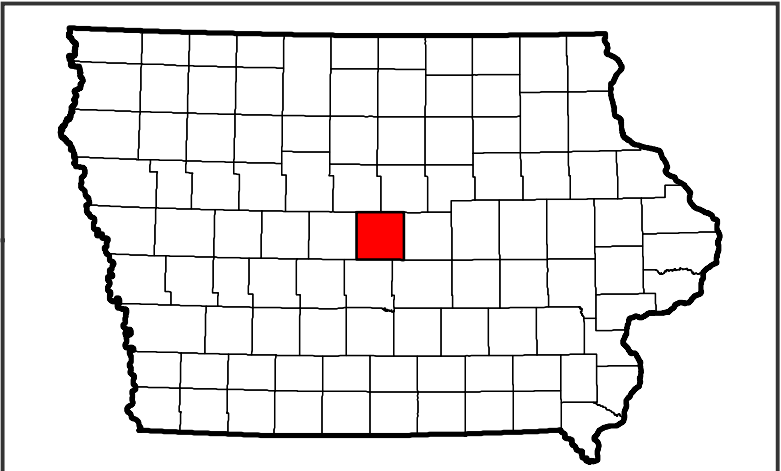

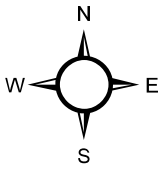

Story County

Nevada, Iowa

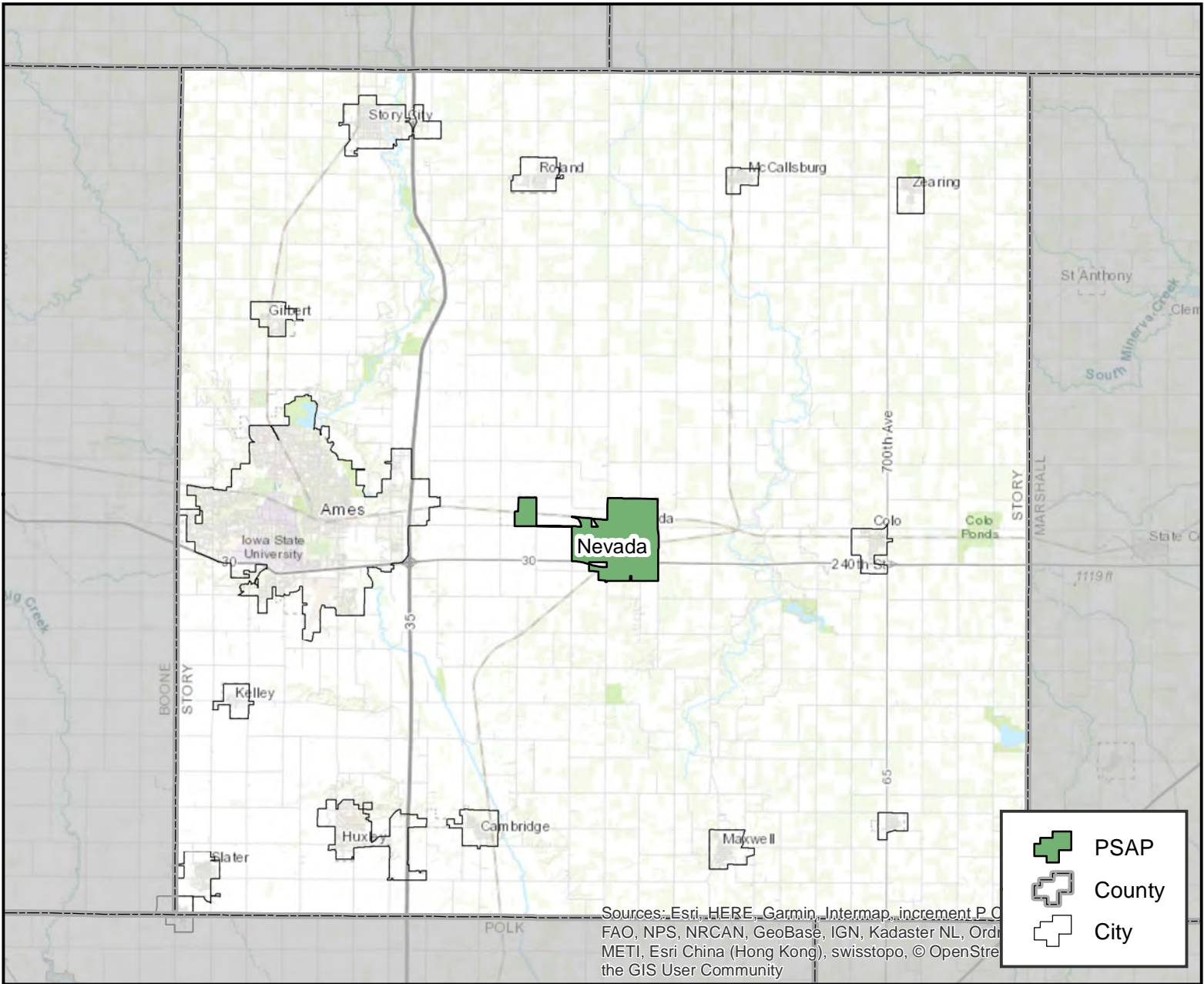

PSAP Information

Story County Sheriff's Office
FCC #: 2016
Phone #: 515-382-6566
1315 S B Ave Nevada, IA 50201

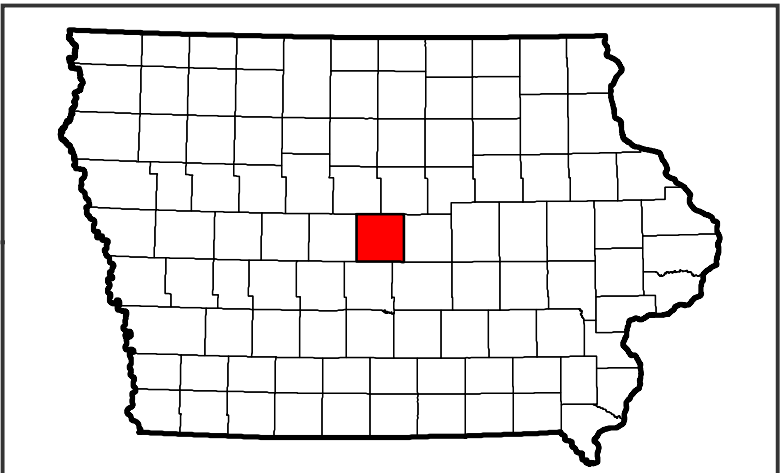

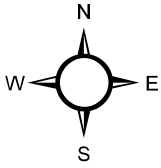

Taylor County

Bedford, Iowa

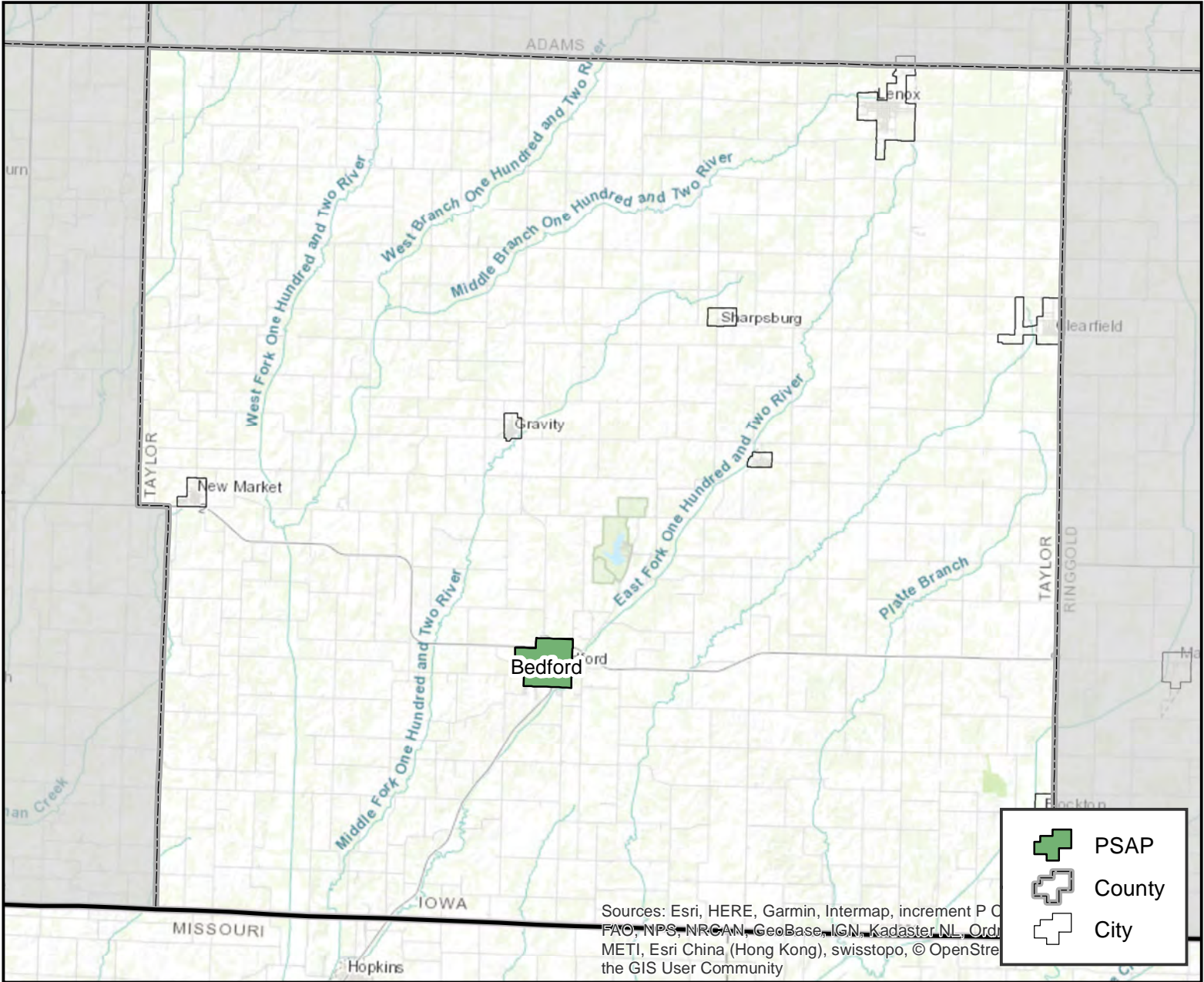

PSAP Information

Taylor County Sheriff's Office
FCC #: 2018
Phone #: 712-523-2153
1601 Justice St Bedford, IA 50833

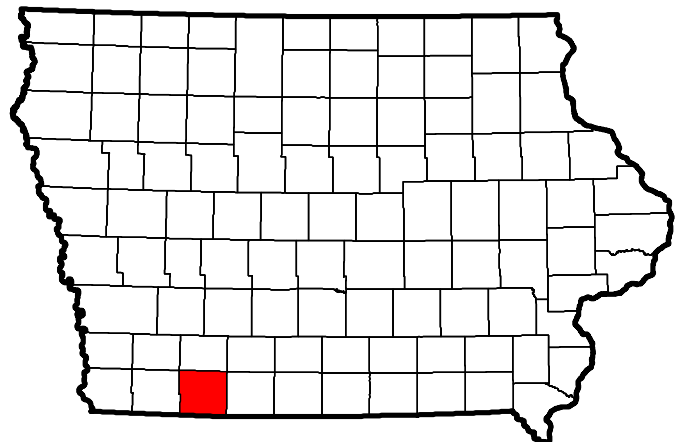

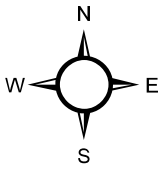

Union County

Creston, Iowa

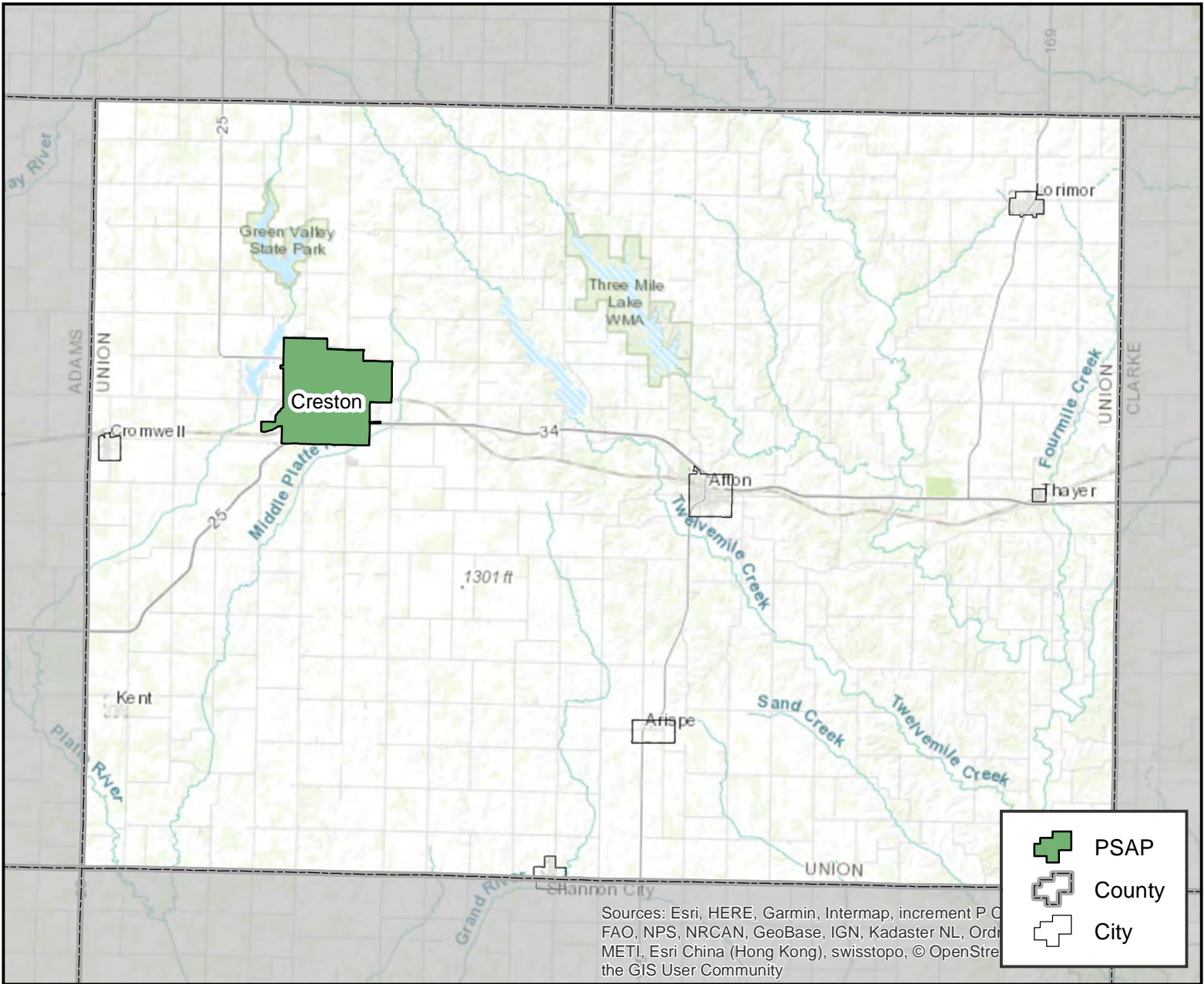

PSAP Information

Union County Sheriff's Office
FCC #: 2019
Phone #: 641-782-8402
302 N Pine St Creston, IA 50801

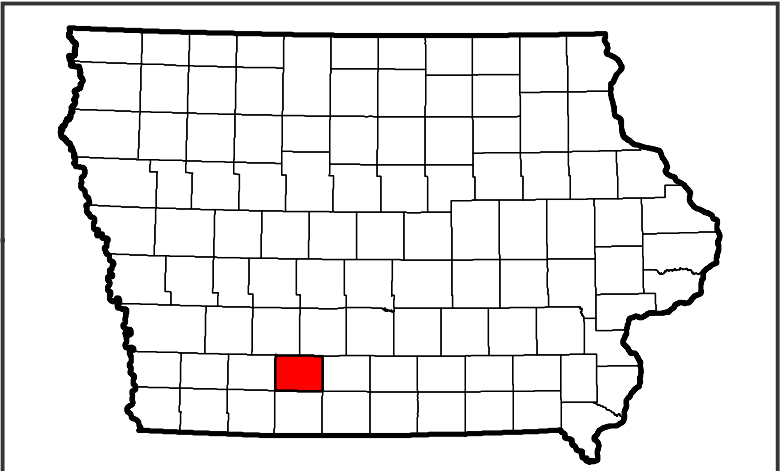

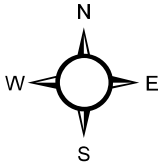

Van Buren County

Keosauqua, Iowa

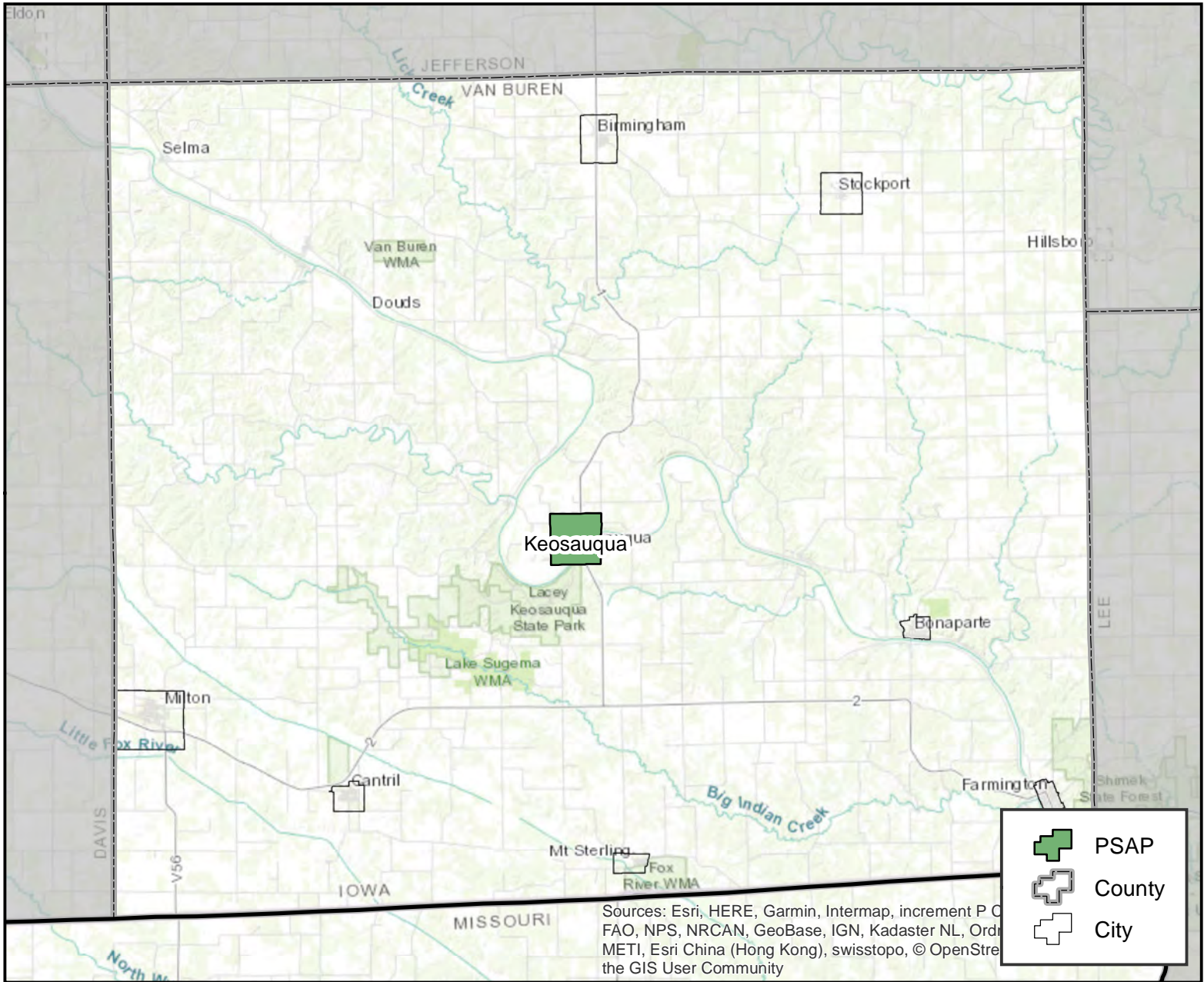

PSAP Information

Van Buren County
FCC #: 2021
Phone #: 319-293-3426
907 Broad St Keosauqua, IA 52565

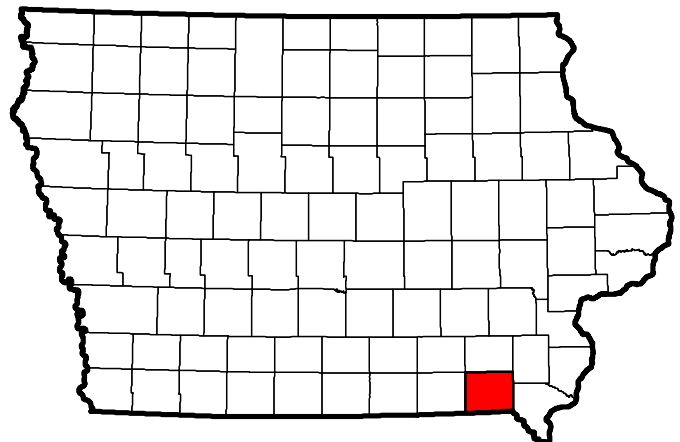

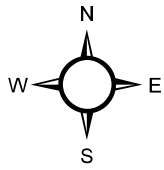

Wapello County

Ottumwa, Iowa

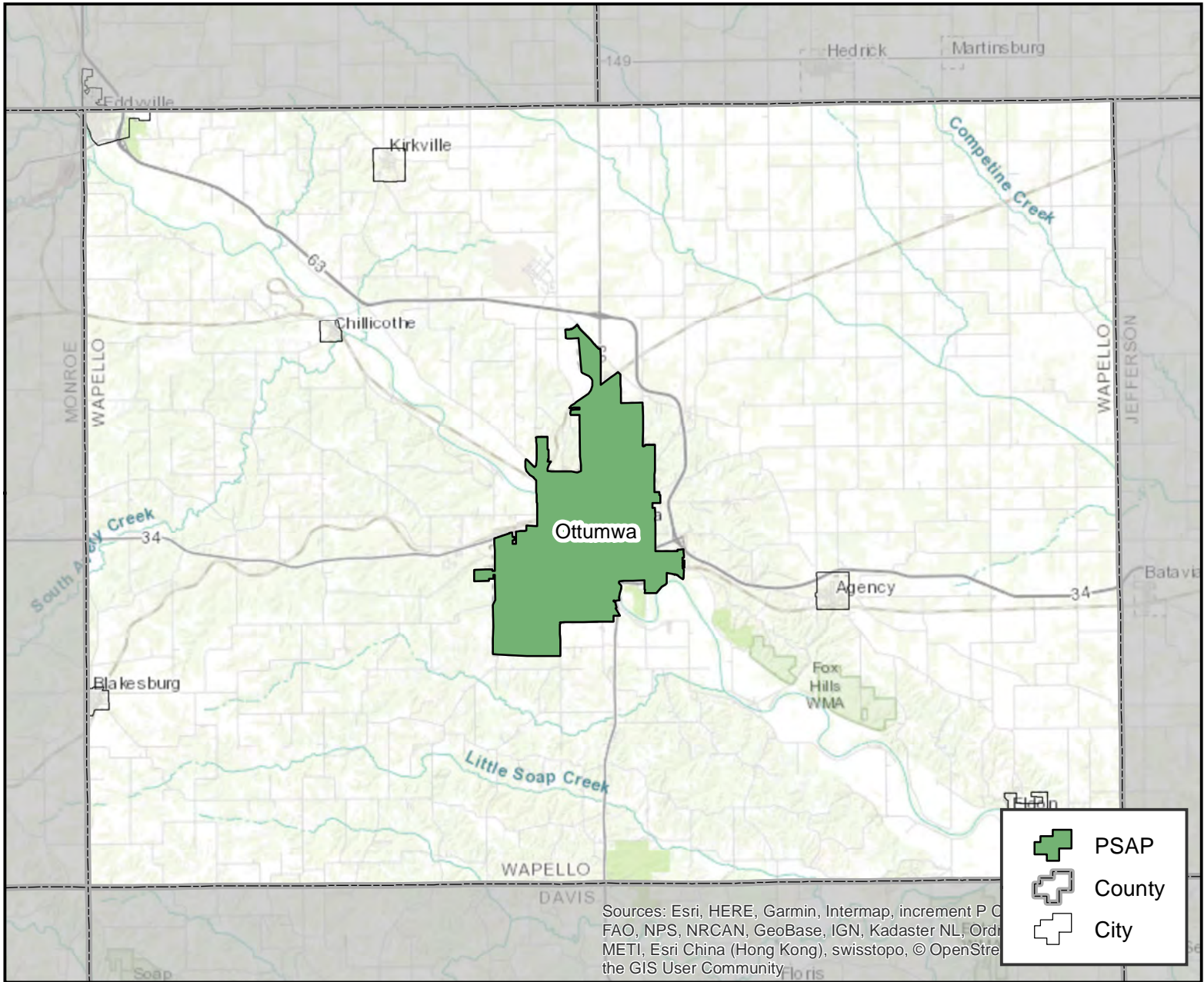

PSAP Information

Ottumwa Police Department
FCC #: 1997
Phone #: 641-683-0661
330 W 2nd St Ottumwa, IA 52501

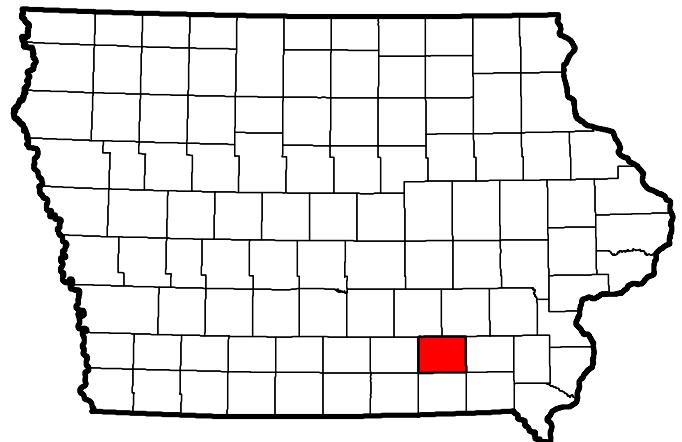

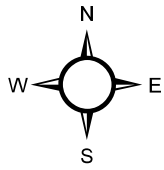

Wapello County

Ottumwa, Iowa

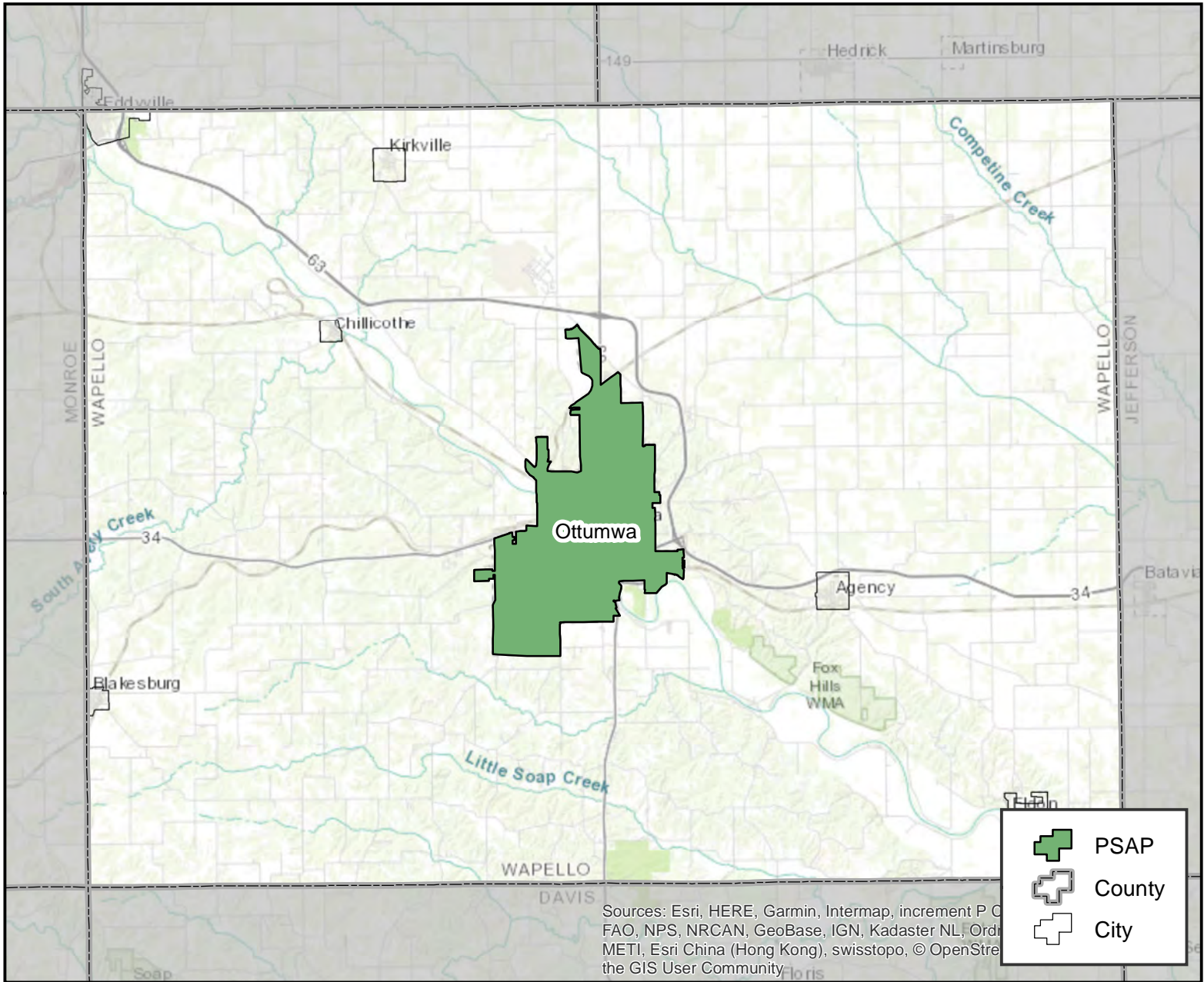

PSAP Information

Wapello County Sheriff's office
FCC #: 2022
Phone #: 641-684-4350
330 W 2nd St Ottumwa, IA 52501

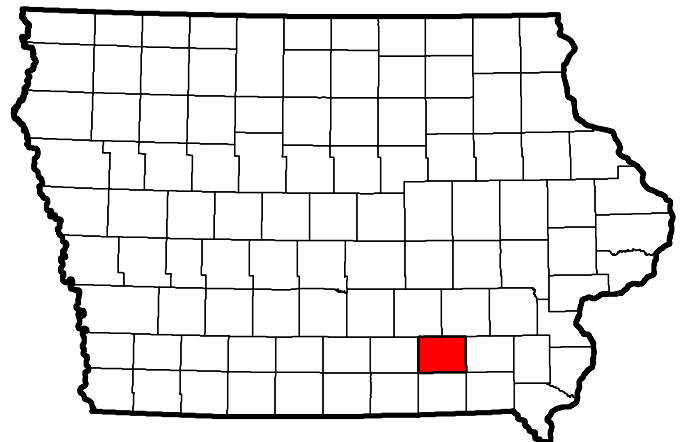

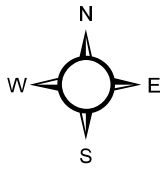

Warren County

Indianola, Iowa

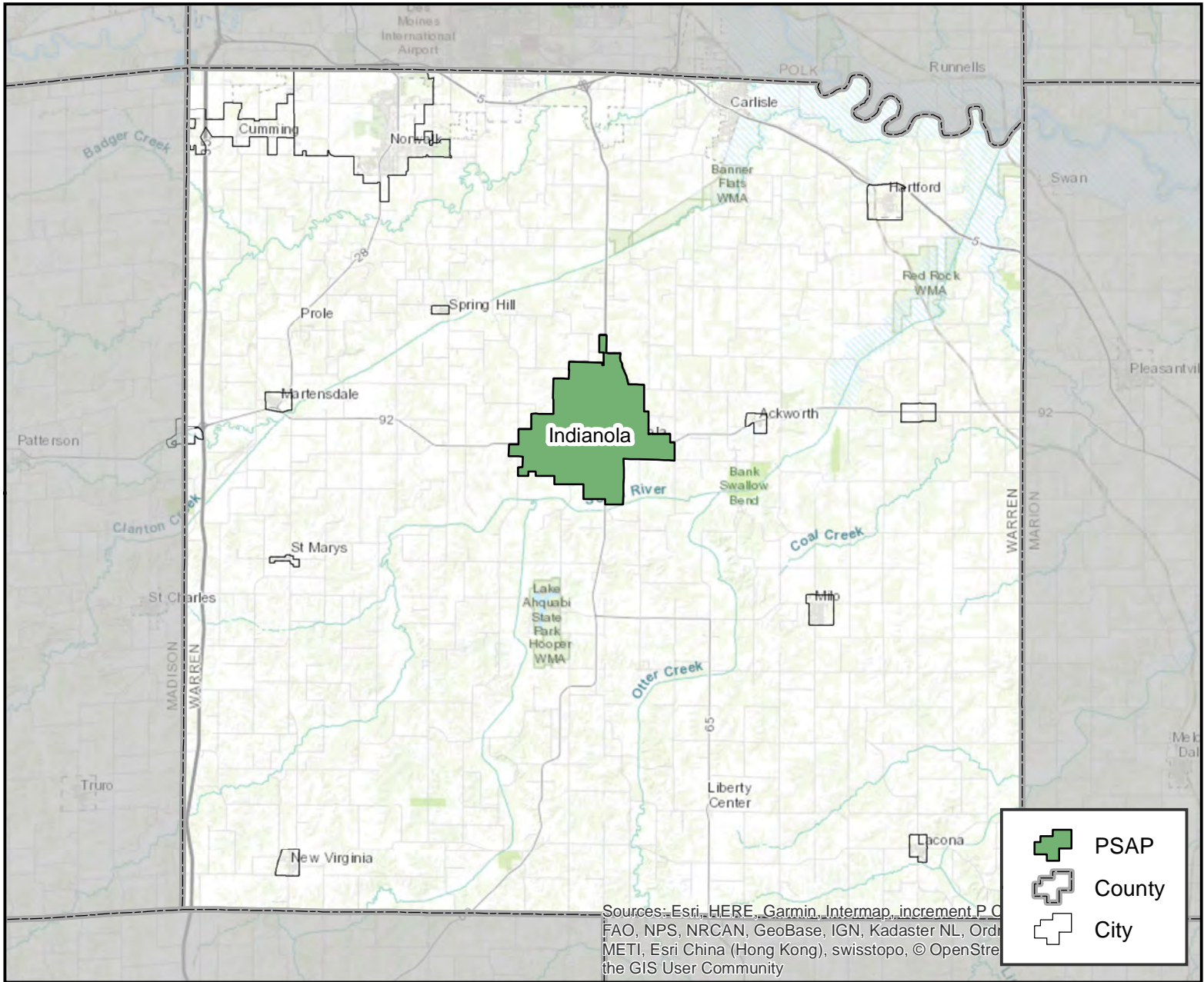

PSAP Information

Warren County Sheriffs Office
FCC #: 2023
Phone #: 515-961-1122
115 North Howard Street Indianola, IA 50125

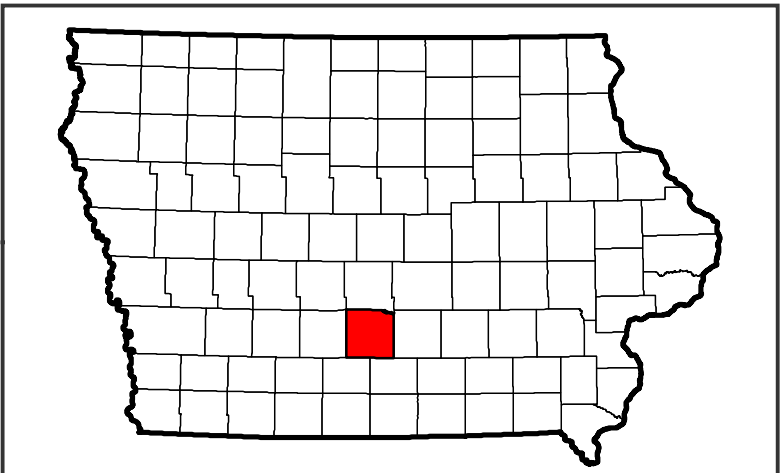

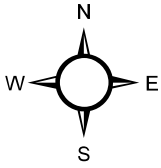

Washington County

Washington, Iowa

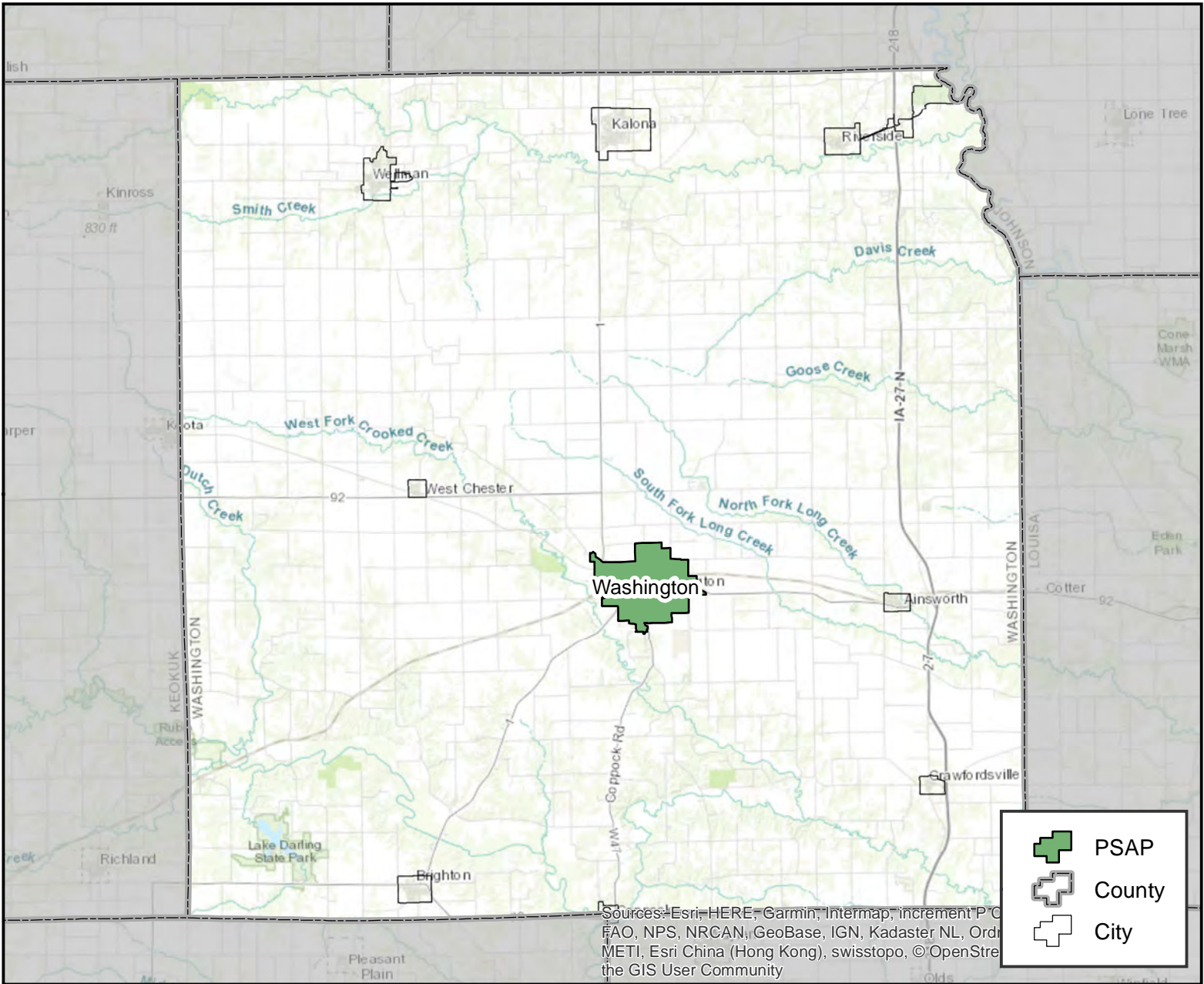

PSAP Information

Washington County 911
FCC #: 2024
Phone #: 319-653-2107
221 West 2nd Street Washington, IA 52353

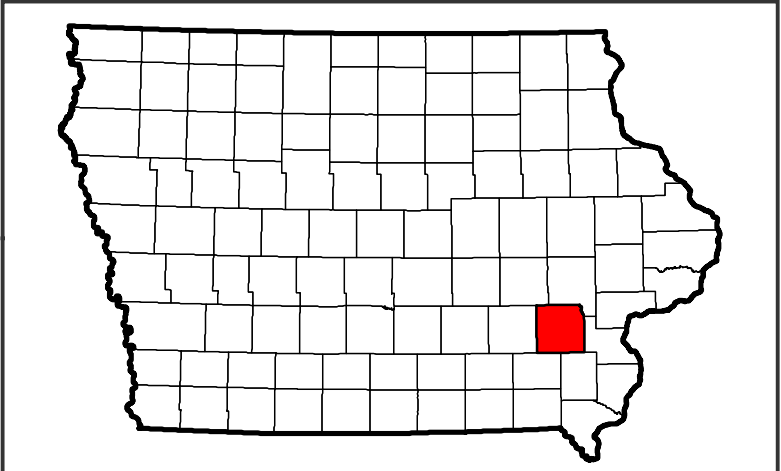

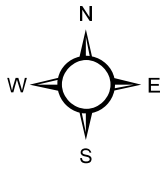

Wayne County

Corydon, Iowa

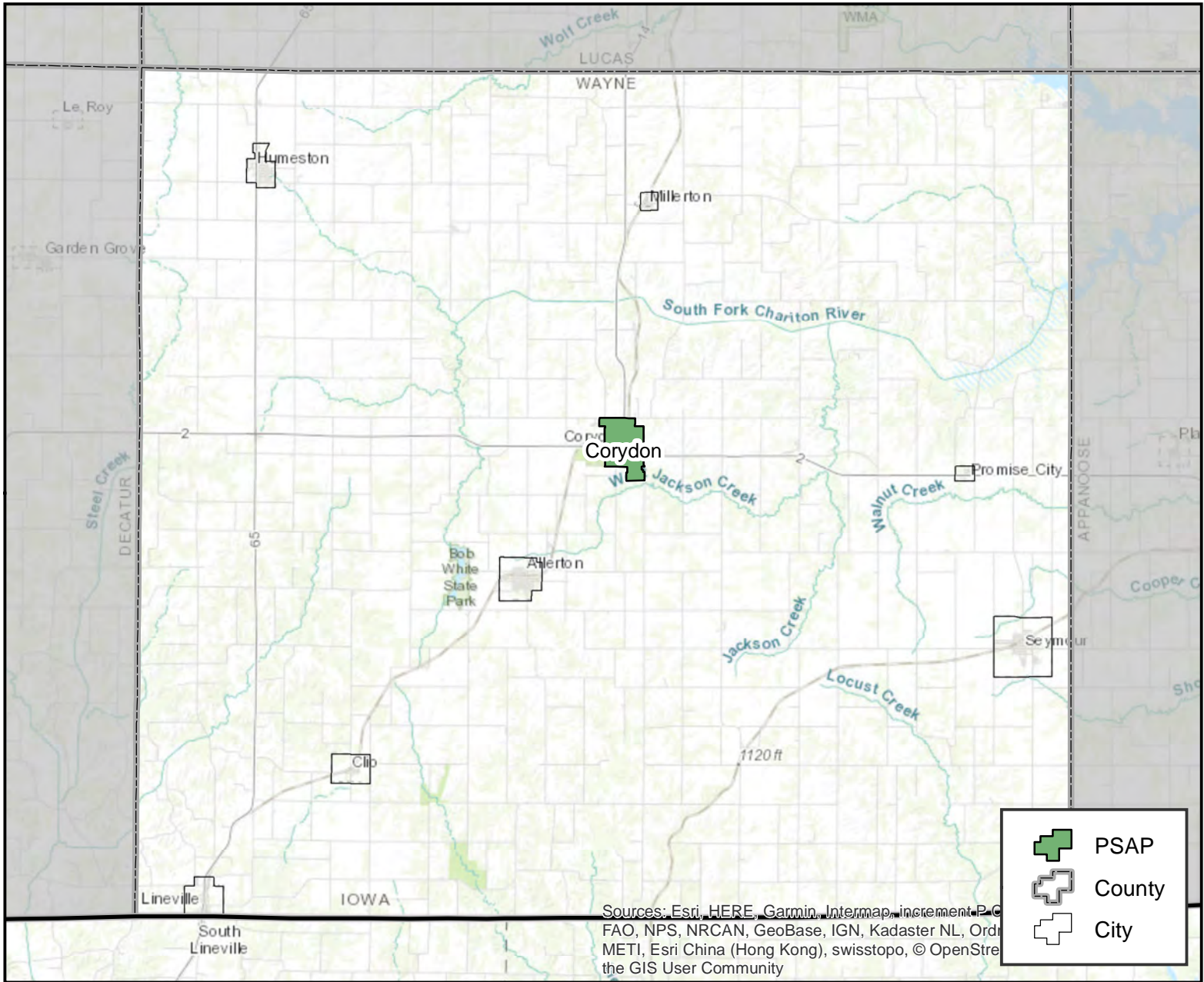

PSAP Information

Wayne County
FCC #: 2025
Phone #: 641-872-1566
207 North Lafayette Corydon, IA 50060

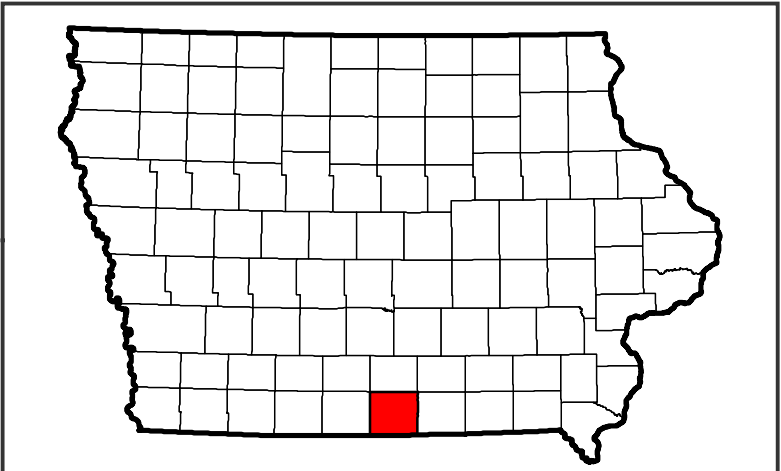

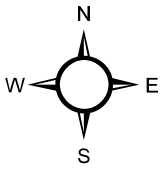

Webster County

Fort Dodge, Iowa

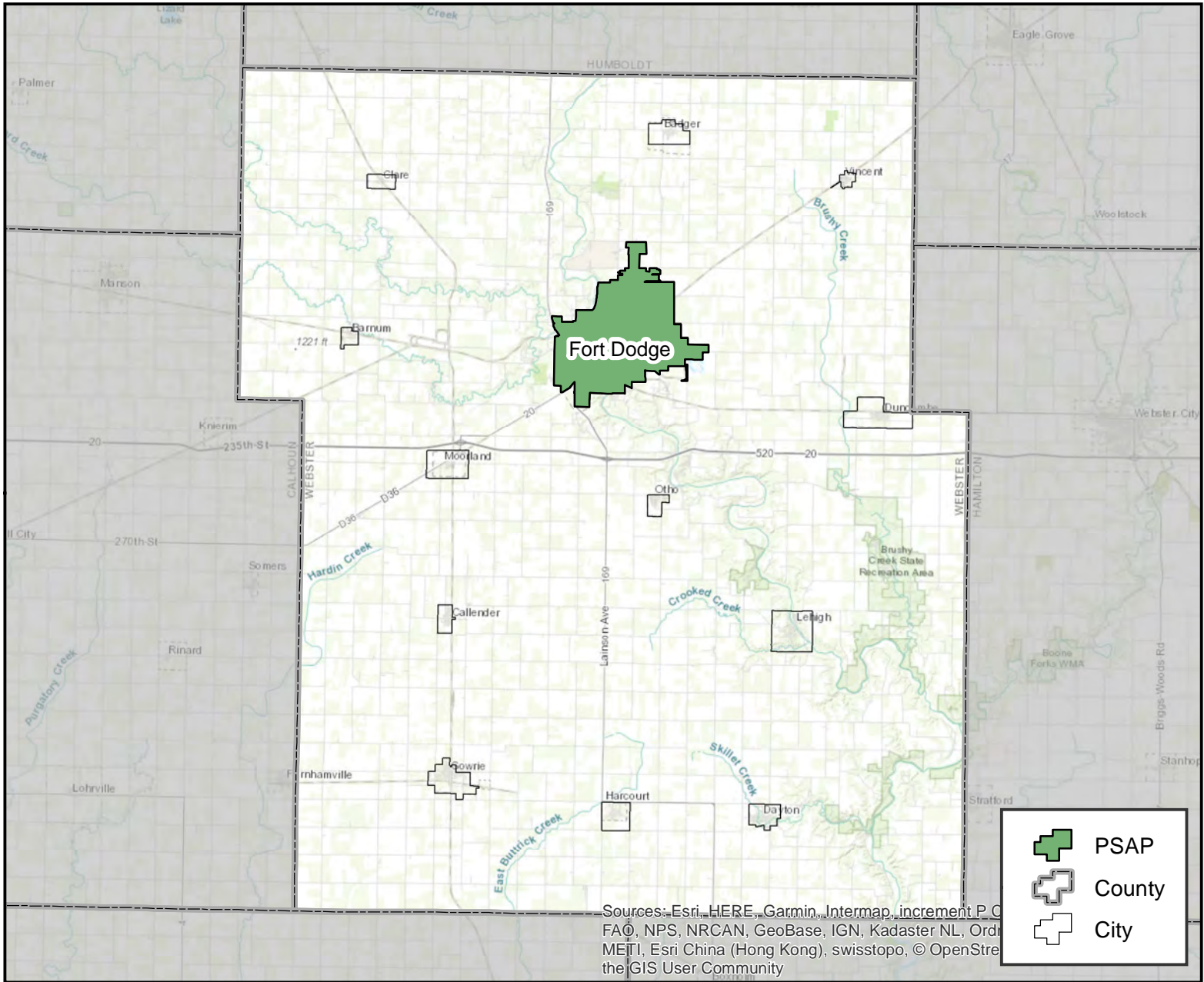

PSAP Information

Webster County Telecommunications
FCC #: 2027
Phone #: 515-573-2323
702 1st Ave South Fort Dodge, IA 50501

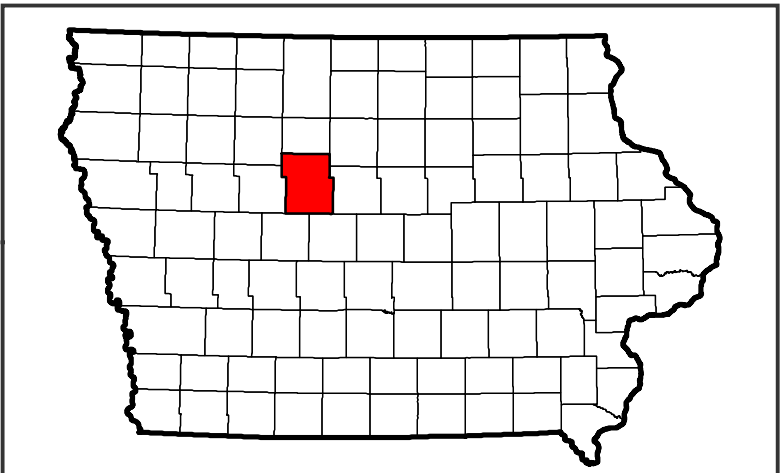

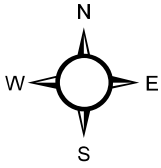

Winnebago County

Forest City, Iowa

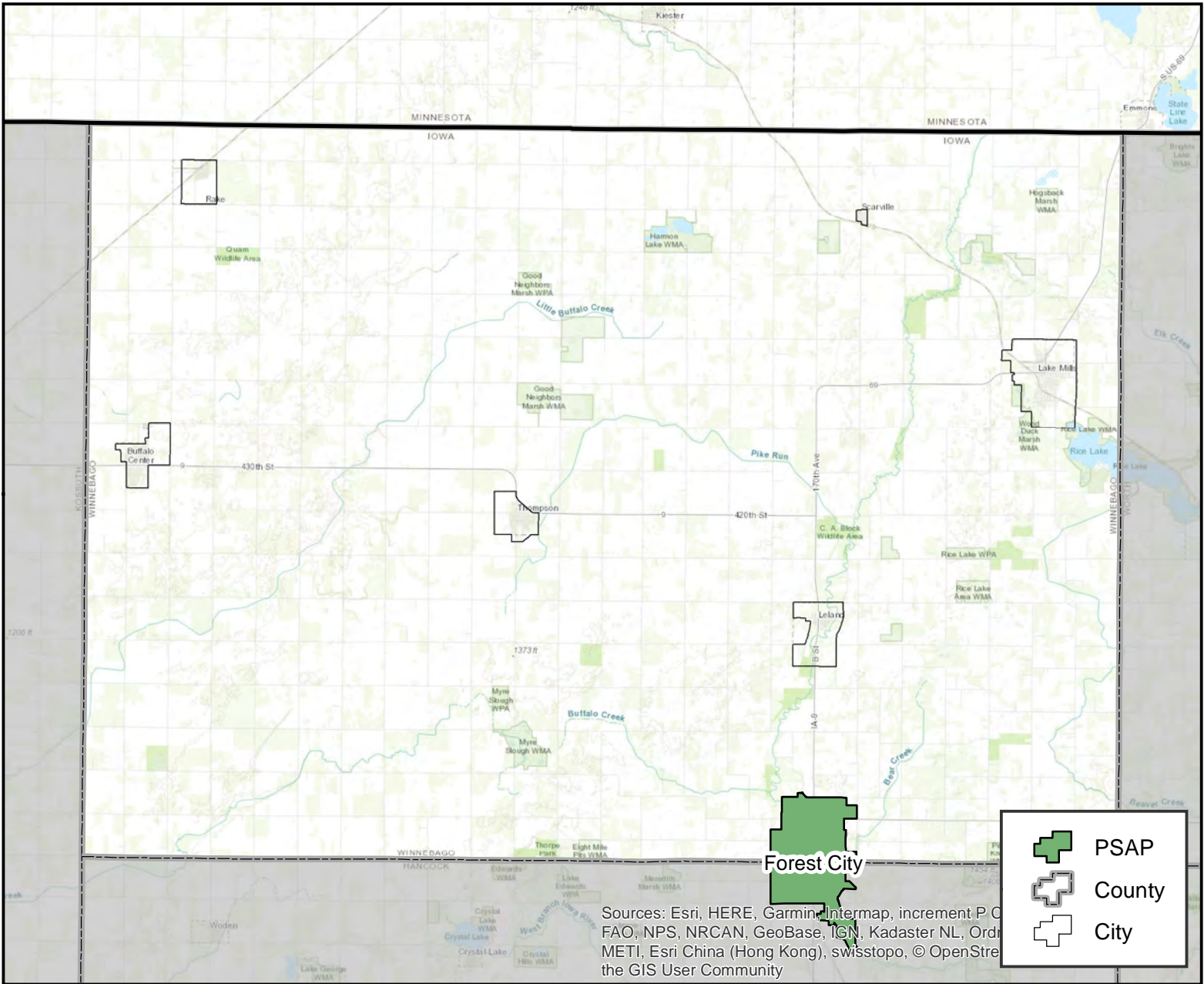

PSAP Information

Winnebago Co Sheriff's Office
FCC #: 2029
Phone #: 641-585-8800
935 Hwy 69 N Forest City, IA 50436

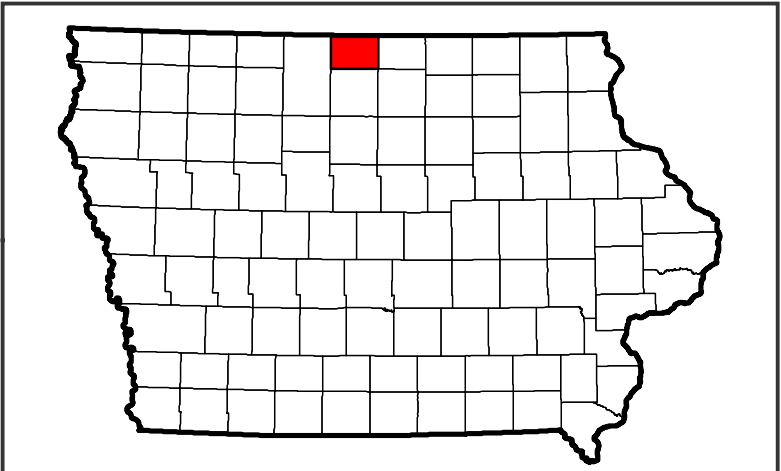

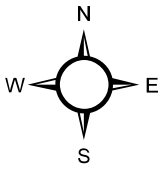

Winneshiek County

Decorah, Iowa

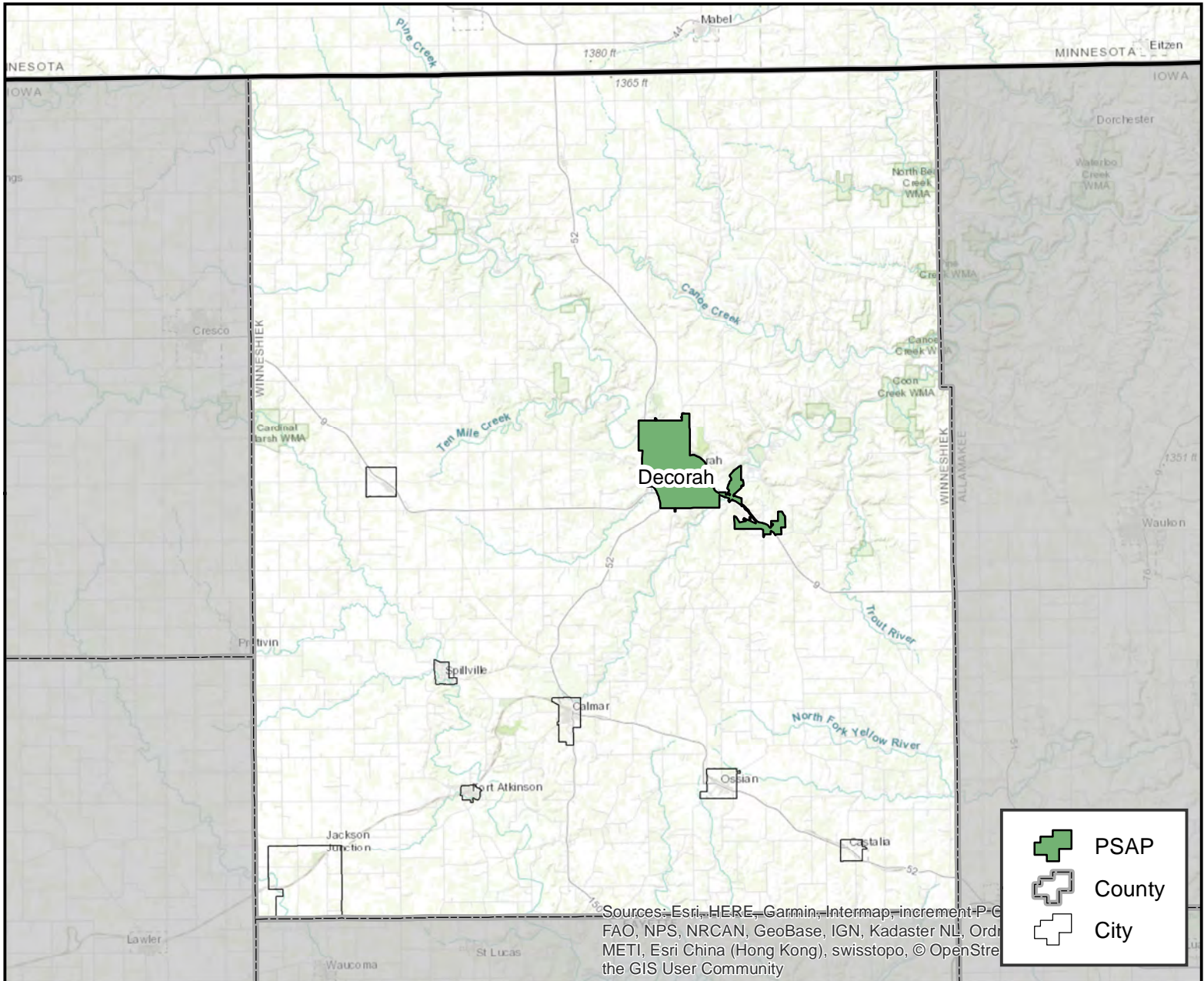

PSAP Information

Decorah PD
FCC #: 1934
Phone #: 563-382-3667
400 Claiborne Dr Decorah, IA 52101

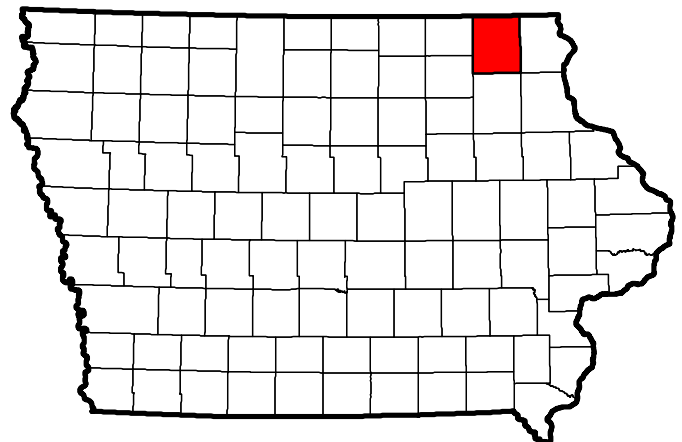

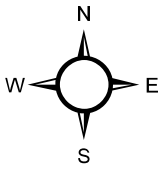

Woodbury County

Sioux City, Iowa

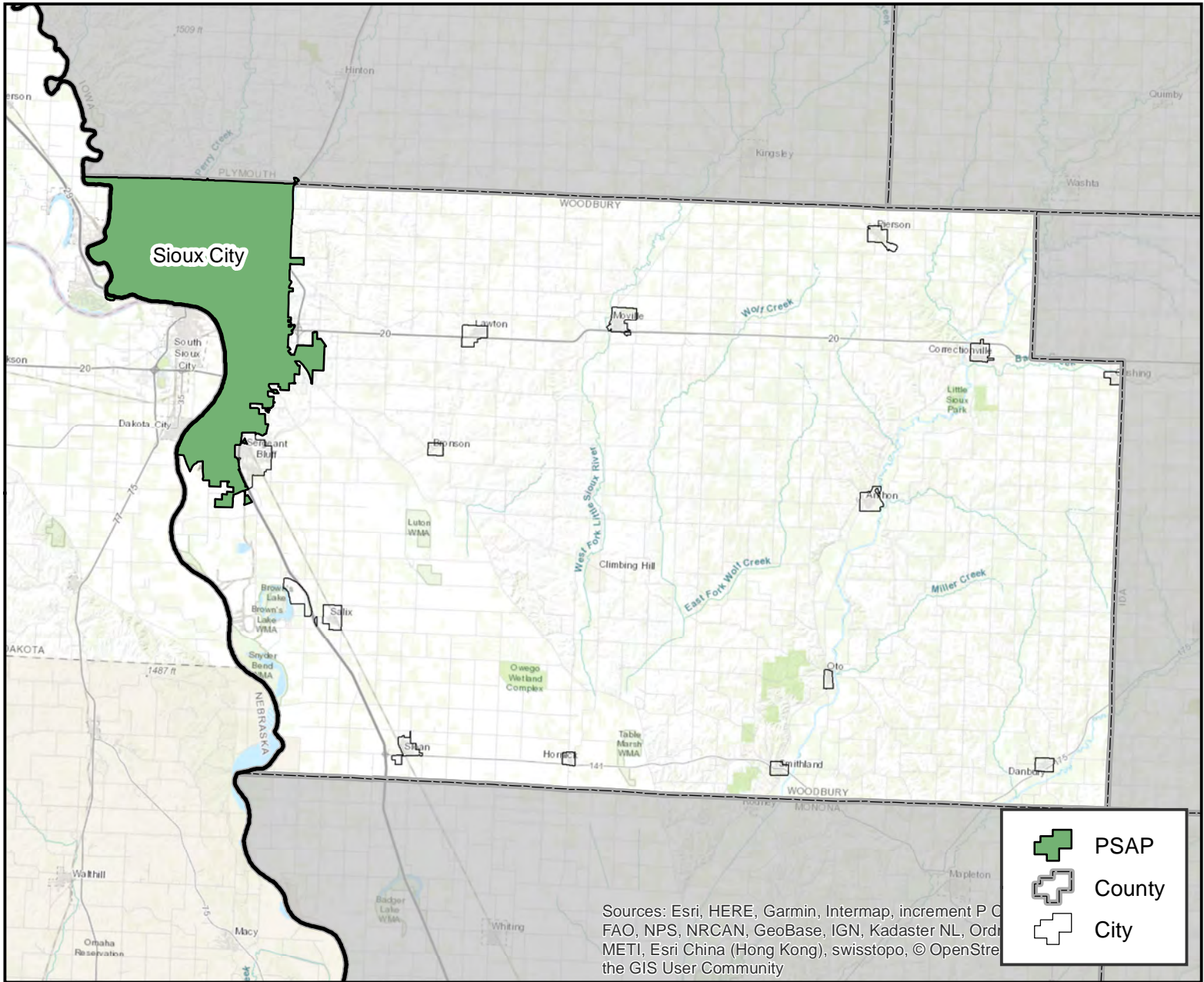

PSAP Information

Woodbury County Communications
FCC #: 2031
Phone #: 712-279-6960
4647 Stone Avenue Sioux City, IA 51106

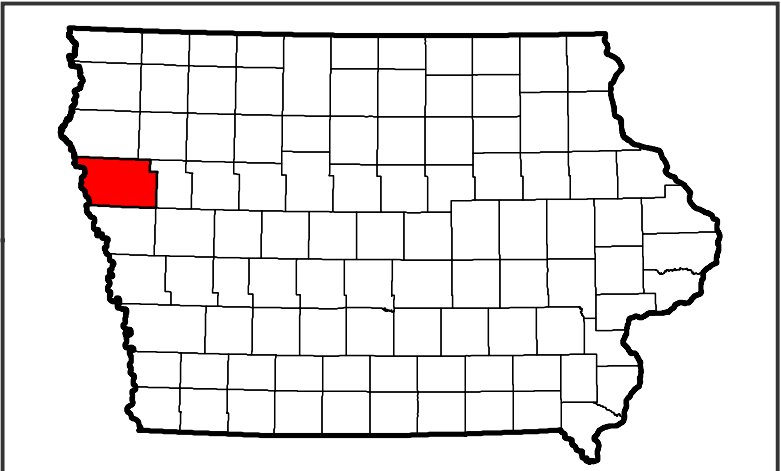

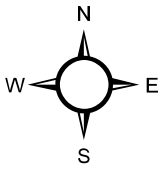

Worth County

Northwood, Iowa

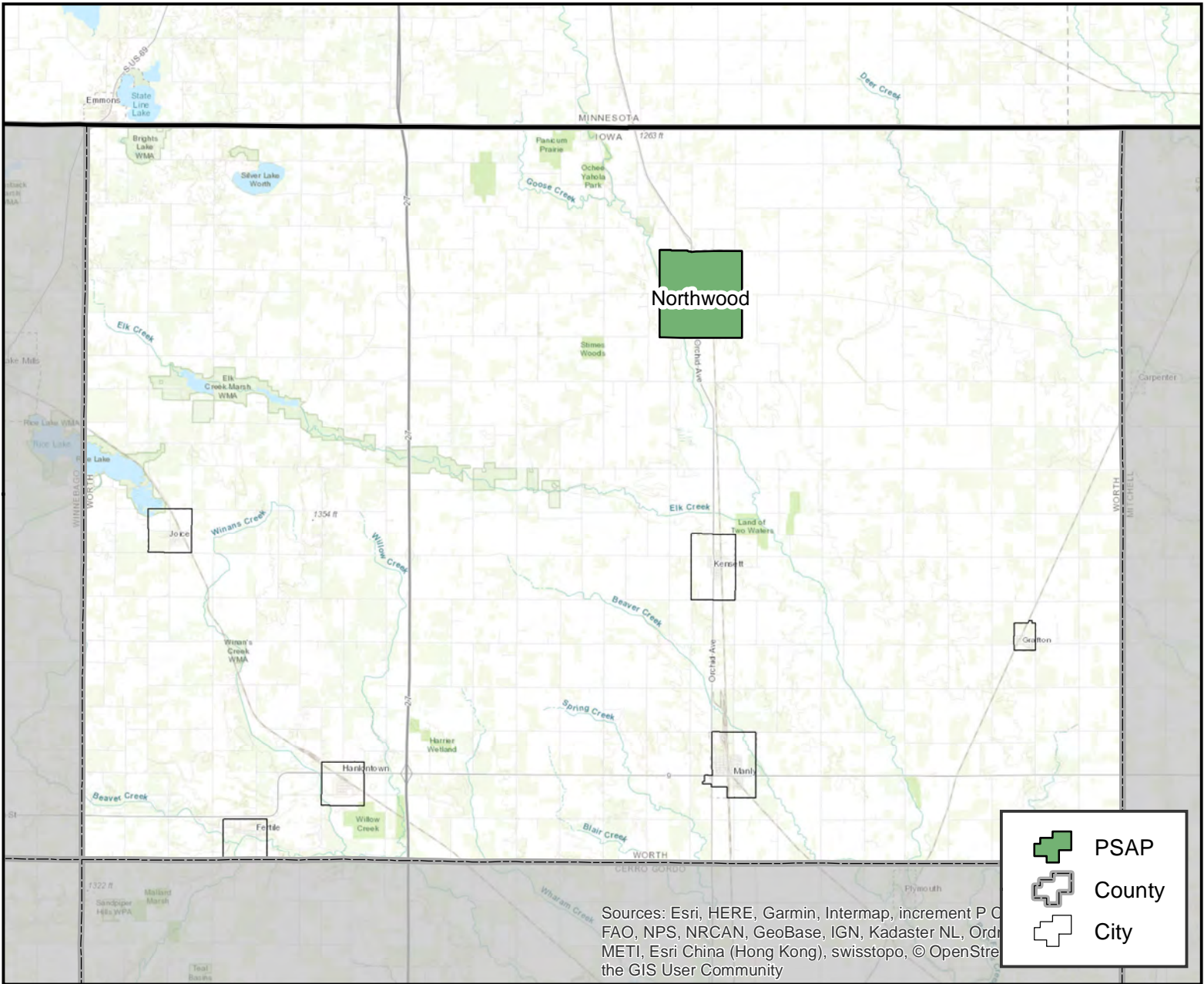

PSAP Information

Worth County Sheriff's Office
FCC #: 2032
Phone #: 641-324-2481
1000 Central Ave Northwood, IA 50459

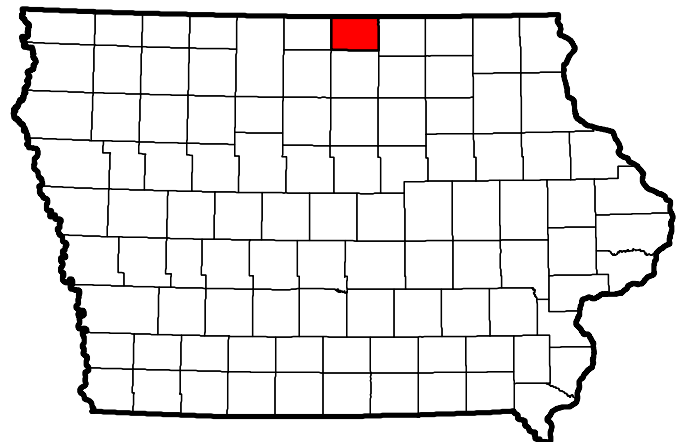

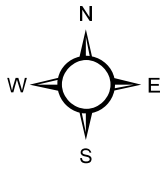

Wright County

Clarion, Iowa

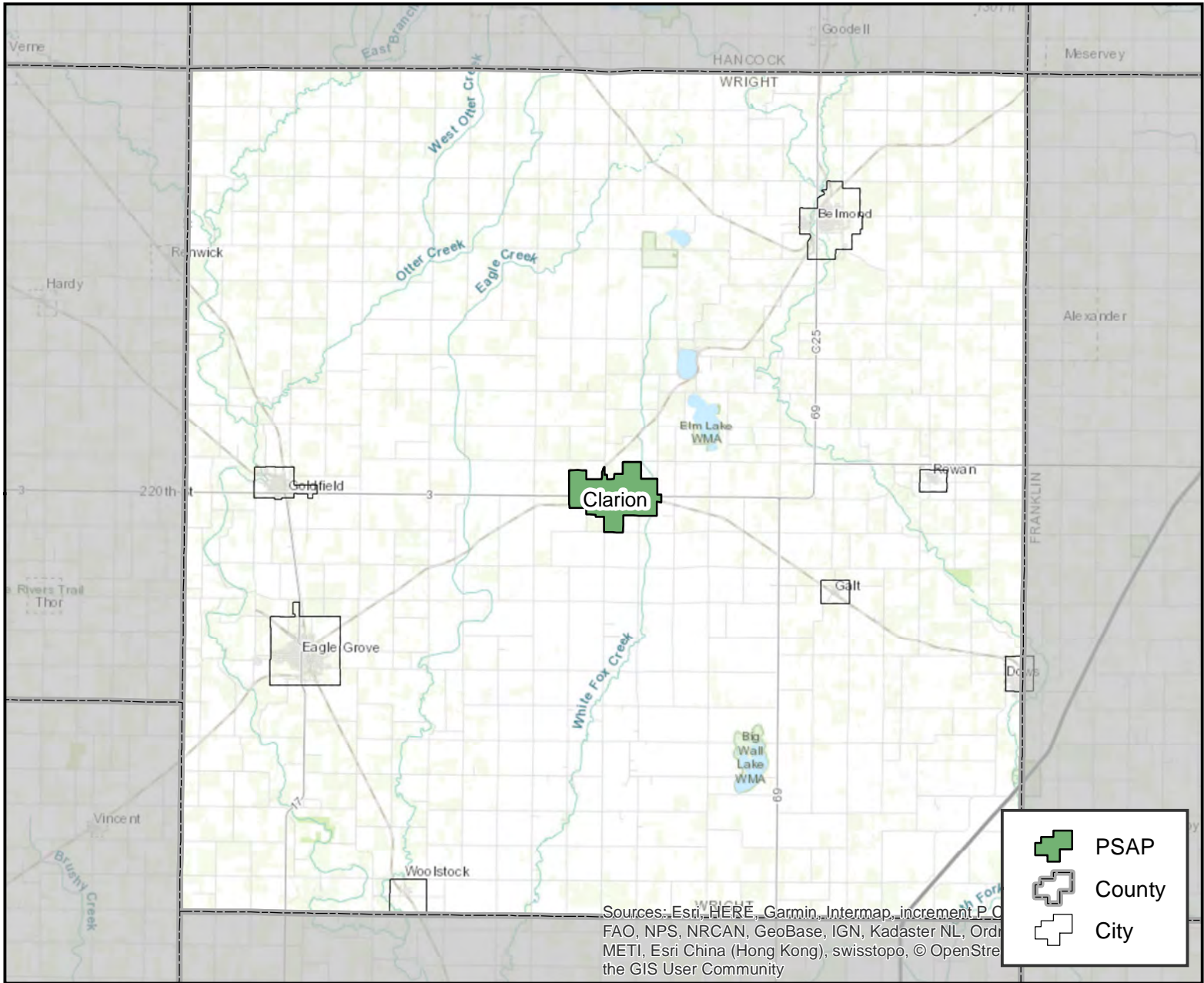

PSAP Information

Wright County Communications
FCC #: 2033
Phone #: 515-532-3722
719 2nd St SW Clarion, IA 50525

